

PART 3

MARKINGS

CHAPTER 3A. GENERAL

Section 3A.01 Functions and Limitations

Support:

- 01 Markings on highways and on private roads open to public travel have important functions in providing guidance and information for the road user. Major marking types include pavement and curb markings, delineators, colored pavements, channelizing devices, and islands. In some cases, markings are used to supplement other traffic control devices such as signs, signals, and other markings. In other instances, markings are used alone to effectively convey regulations, guidance, or warnings in ways not obtainable by the use of other devices.
- 02 Markings have limitations. Visibility of the markings can be limited by snow, debris, and water on or adjacent to the markings. Marking durability is affected by material characteristics, traffic volumes, weather, and location. However, under most highway conditions, markings provide important information while allowing minimal diversion of attention from the roadway.

Section 3A.02 Standardization of Application

Standard:

- 01 **Each standard marking shall be used only to convey the meaning prescribed for that marking in this Manual. When used for applications not described in this Manual, markings shall conform in all respects to the principles and standards set forth in this Manual.**

Guidance:

- 02 *Before any new highway, private road open to public travel (see definition in Section 1A.13), paved detour, or temporary route is opened to public travel; all necessary markings should be in place.*

Standard:

- 03 **Markings that must be visible at night shall be retroreflective unless ambient illumination assures that the markings are adequately visible. All markings on Interstate highways shall be retroreflective.**
- 04 **Markings that are no longer applicable for roadway conditions or restrictions and that might cause confusion for the road user shall be removed or obliterated to be unidentifiable as a marking as soon as practical.**

Option:

- 05 Until they can be removed or obliterated, markings may be temporarily masked with tape that is approximately the same color as the pavement.

Section 3A.03 Maintaining Minimum Pavement Marking Retroreflectivity

(This Section is reserved for future text based on FHWA rulemaking.)

Section 3A.04 Materials

Support:

- 01 Pavement and curb markings are commonly placed by using paints or thermoplastics; however, other suitable marking materials, including raised pavement markers and colored pavements, are also used. Delineators channelizing devices are visibly placed in a vertical position similar to signs above the roadway.
- 02 Some marking systems consist of clumps or droplets of material with visible open spaces of bare pavement between the material droplets. These marking systems can function in a manner that is similar to the marking systems that completely cover the pavement surface and are suitable for use as pavement markings if they meet the other pavement marking requirements of the highway agency.
- 02a [The “Line Striping Material Selection Policy” contains further information regarding line striping material selection. This document can be obtained from the State Highway Administration’s Office of Traffic & Safety, Traffic Engineering Design Division at the address shown on Page i.](#)

Guidance:

- 03 *The materials used for markings should provide the specified color throughout their useful life.*

04 *Consideration should be given to selecting pavement marking materials that will minimize tripping or loss of traction for road users, including pedestrians, bicyclists, and motorcyclists.*

05 *Delineators should not present a vertical or horizontal clearance obstacle for pedestrians.*

Section 3A.05 Colors

Standard:

01 **Markings shall be yellow, white, red, blue, or purple. The colors for markings shall conform to the standard highway colors. Black in conjunction with one of the colors mentioned in the first sentence of this paragraph shall be a usable color.**

02 **When used, white markings for longitudinal lines shall delineate:**

- A. The separation of traffic flows in the same direction, or
- B. The right-hand edge of the roadway.

03 **When used, yellow markings for longitudinal lines shall delineate:**

- A. The separation of traffic traveling in opposite directions,
- B. The left-hand edge of the roadways of divided highways and one-way streets or ramps, or
- C. The separation of two-way left-turn lanes and reversible lanes from other lanes.

04 **When used, red raised pavement markers or delineators shall delineate:**

- A. Truck escape ramps, or
- B. One-way roadways, ramps, or travel lanes that shall not be entered or used in the direction from which the markers are visible.

05 **When used, blue markings shall supplement white markings for parking spaces for persons with disabilities.**

06 **When used, purple markings shall supplement lane line or edge line markings for toll plaza approach lanes that are restricted to use only by vehicles with registered electronic toll collection accounts.**

Option:

07 Colors used for official route shield signs (see Section 2D.11) may be used as colors of symbol markings to simulate route shields on the pavement (see Section 3B.20.)

08 Black may be used in combination with the colors mentioned in the first sentence of Paragraph 1 where a light-colored pavement does not provide sufficient contrast with the markings.

Support:

09 When used in combination with other colors, black is not considered a marking color, but only a contrast-enhancing system for the markings.

Section 3A.06 Functions, Widths, and Patterns of Longitudinal Pavement Markings

Standard:

01 **The general functions of longitudinal lines shall be:**

- A. A double line indicates maximum or special restrictions,
- B. A solid line discourages or prohibits crossing (depending on the specific application),
- C. A broken line indicates a permissive condition, and
- D. A dotted line provides guidance or warning of a downstream change in lane function.
- E. A double broken line indicates a reversible lane application.

02 **The widths and patterns of longitudinal lines shall be as follows:**

- A. Normal line—4 to 6 inches wide.

A-1. Normal line —5 inches wide on State owned, operated, and maintained roadways.

- B. Wide line—at least twice the width of a normal line.
- C. Double line —two parallel lines separated by a discernible space.
- D. Broken line—normal line segments separated by gaps.
- E. Dotted line—noticeably shorter line segments separated by shorter gaps than used for a broken line. The width of a dotted line extension shall be at least the same as the width of the line it extends.

Support:

03 The width of the line indicates the degree of emphasis.

Guidance:

- 04 *Broken lines should consist of 10-foot line segments and 30-foot gaps, or dimensions in a similar ratio of line segments to gaps as appropriate for traffic speeds and need for delineation.*

Support:

- 05 Patterns for dotted lines depend on the application (see Sections 3B.04 and 3B.08.)
- 05a Dotted lines are used to separate mandatory lane use, guide double and triple turn movements, and delineate speed change lanes and non-continuous lanes.

Guidance:

- 06 A dotted line for line extensions within an intersection or taper area should consist of 2-foot line segments and 2- to 6-foot gaps. A dotted line used as a lane line should consist of 3-foot line segments and 9-foot gaps.
- 06a On State owned, operated, and maintained roadways, dotted lines are subdivided into four categories:
- 06b Type I ("Puppy tracks"), 5 inches wide, should have segments 3-foot in length and gaps 9-foot in length. Type I tracks are normally used on conventional roadways to separate mandated use lanes.
- 06c Type II ("Elephant tracks"), 10 inches wide, used on expressways and highways or for added emphasis in other areas, should have segments 3-foot in length and gaps nine 9-foot in length to separate mandated use lanes.
- 06d Type III ("Line Extension"), 5 inches wide, should have segments 3-foot in length and gaps 3-foot in length. Type III tracks are normally used on edge line extensions through intersections or roadway junctions and to guide multiple turn movements.
- 06e Type IV ("Wide Line Extension"), 10 inches wide, should have segments 3-foot in length and gaps 3-foot in length. Type IV tracks are normally used on edge line extensions through expressway or roadway junctions.

Figure 3A-1a. Dotted Lines

a - Type I "Puppy" - Conventional Roadways

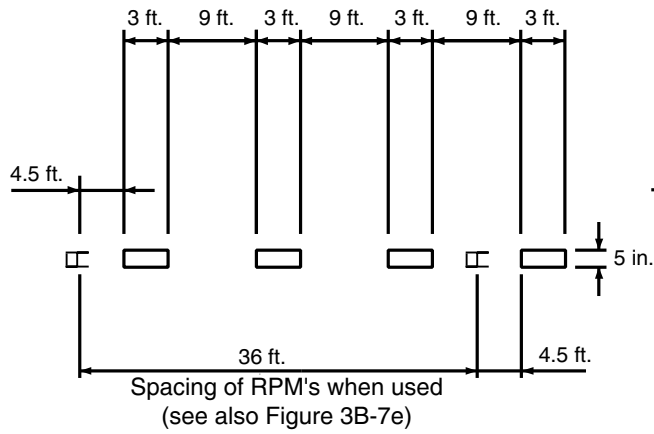

b - Type II "Elephant" - Expressway / Freeway

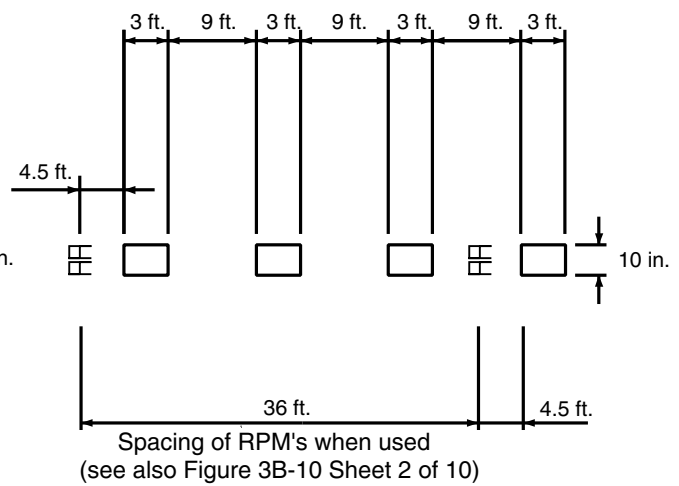

c - Type III "Line Extension" - Intersection/Roadway Junction

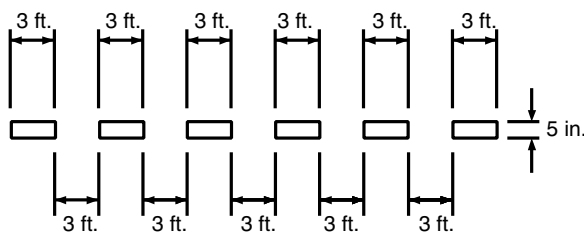

d. Type IV "Wide Line Extension" - Expressway/Roadway Junction

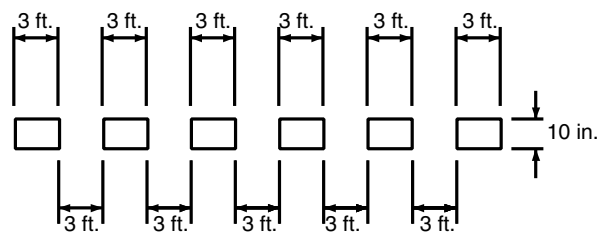

CHAPTER 3B. PAVEMENT AND CURB MARKINGS

Section 3B.01 Yellow Center Line Pavement Markings and Warrants

Standard:

01 **Center line pavement markings, when used, shall be the pavement markings used to delineate the separation of traffic lanes that have opposite directions of travel on a roadway and shall be yellow.**

Option:

02 Center line pavement markings may be placed at a location that is not the geometric center of the roadway.

03 On roadways without continuous Center line pavement markings, short sections may be marked with Center line pavement markings to control the position of traffic at specific locations, such as around curves, over hills, on approaches to grade crossings, at grade crossings, and at bridges.

Standard:

04 **The center line markings on two-lane, two-way roadways shall be one of the following as shown in Figure 3B-1:**

- A. **Two-direction passing zone markings consisting of a normal broken yellow line where crossing the center line markings for passing with care is permitted for traffic traveling in either direction;**
- B. **One-direction no-passing zone markings consisting of a double yellow line, one of which is a normal broken yellow line and the other is a normal solid yellow line, where crossing the center line markings for passing with care is permitted for the traffic traveling adjacent to the broken line, but is prohibited for traffic traveling adjacent to the solid line; or**
- C. **Two-direction no-passing zone markings consisting of two normal solid yellow lines where crossing the center line markings for passing is prohibited for traffic traveling in either direction.**

05 **A single solid yellow line shall not be used as a center line marking on a two-way roadway.**

06 **The center line markings on undivided two-way roadways with four or more lanes for moving motor vehicle traffic always available shall be the two-direction no-passing zone markings consisting of a solid double yellow line as shown in Figure 3B-2.**

06a **On State owned and operated roadways, raised pavement markers (RPM) (see Section 3B.11), when added to center lines, shall conform to Figure 3B-2b.**

Guidance:

07 *On two-way roadways with three through lanes for moving motor vehicle traffic, two lanes should be designated for traffic in one direction by using one- or two-direction no-passing zone markings as shown in Figure 3B-3.*

Support:

08 Sections 11-301(c) and 11-311(c) of the “Uniform Vehicle Code (UVC)” contain information regarding left turns across center line no-passing zone markings and paved medians, respectively. The UVC can be obtained from the National Committee on Uniform Traffic Laws and Ordinances at the address shown on Page i.

08a **Additional raised pavement marker guidelines are contained in the Pavement Marking Manual. This document can be obtained from the Maryland State Highway Administration’s Office of Traffic & Safety, Traffic Engineering Design Division (TEDD) at the address shown on Page i.**

Standard:

09 **Center line markings shall be placed on all paved urban arterials and collectors that have a traveled way of 20 feet or more in width and an ADT of 6,000 vehicles per day or greater. Center line markings shall also be placed on all paved two-way streets or highways that have three or more lanes for moving motor vehicle traffic.**

Guidance:

10 *Center line markings should be placed on paved urban arterials and collectors that have a traveled way of 20 feet or more in width and an ADT of 4,000 vehicles per day or greater. Center line markings should also be placed on all rural arterials and collectors that have a traveled way of 18 feet or more in width and an ADT of 3,000 vehicles per day or greater. Center line markings should also be placed on other traveled ways where an engineering study indicates such a need.*

11 *Engineering judgment should be used in determining whether to place center line markings on traveled ways that are less than 16 feet wide because of the potential for traffic encroaching on the pavement edges, traffic being affected by parked vehicles, and traffic encroaching into the opposing traffic lane.*

Figure 3B-1. Examples of Two-Lane, Two-Way Marking Applications

A - Typical two-lane, two-way marking with passing permitted in both directions

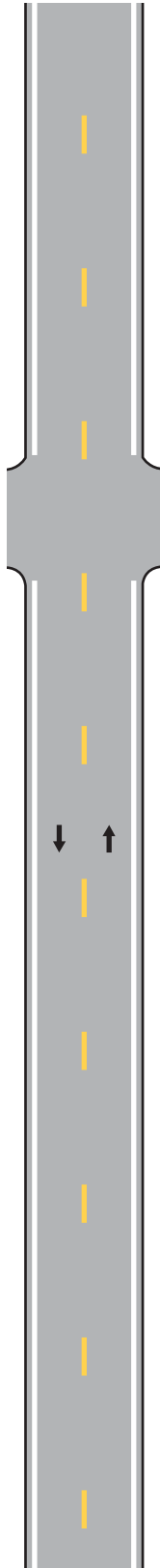

B - Typical two-lane, two-way marking with no-passing zones

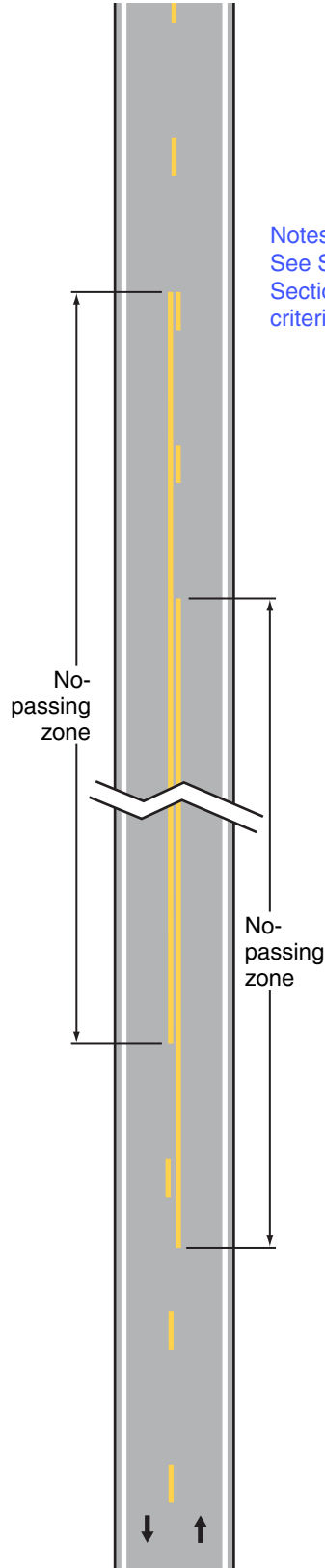

Legend
→ Direction of travel

Notes:
See Section 2B.28 and
Section 2B.29 for signing
criteria.

Figure 3B-1a. Examples of NO-PASSING Zone Pavement Marking Application

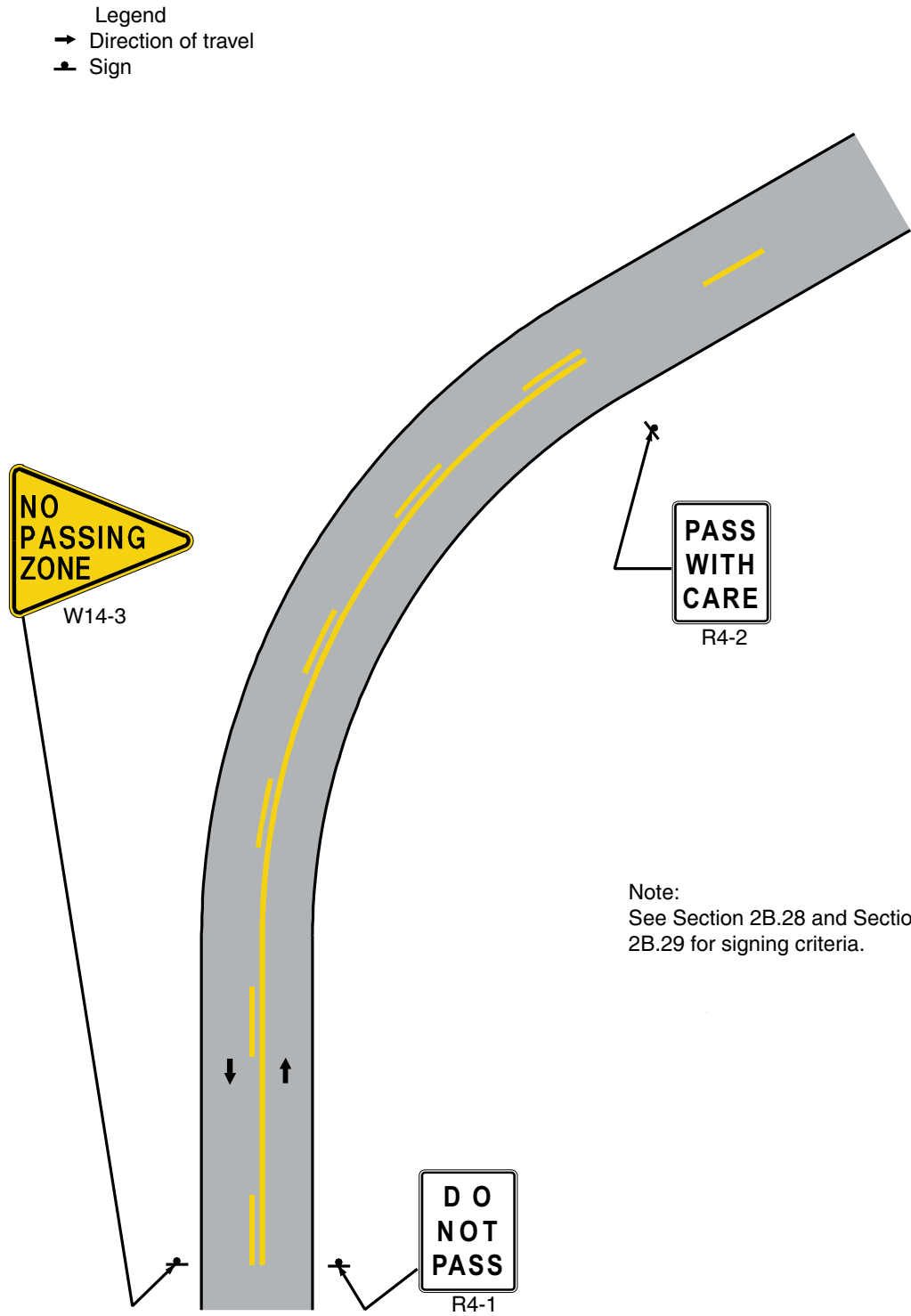
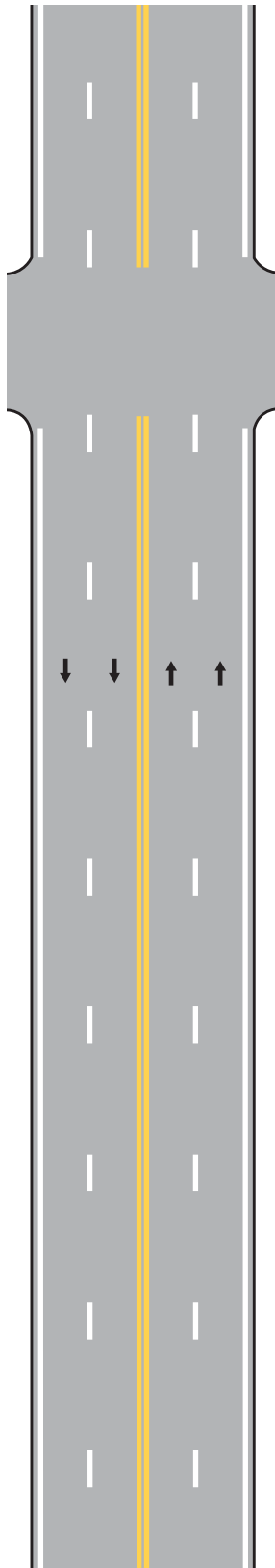

Figure 3B-2. Examples of Four-or-More Lane, Two-Way Marking Applications

A - Typical multi-lane, two-way marking



B - Typical multi-lane, two-way marking with single lane left turn channelization

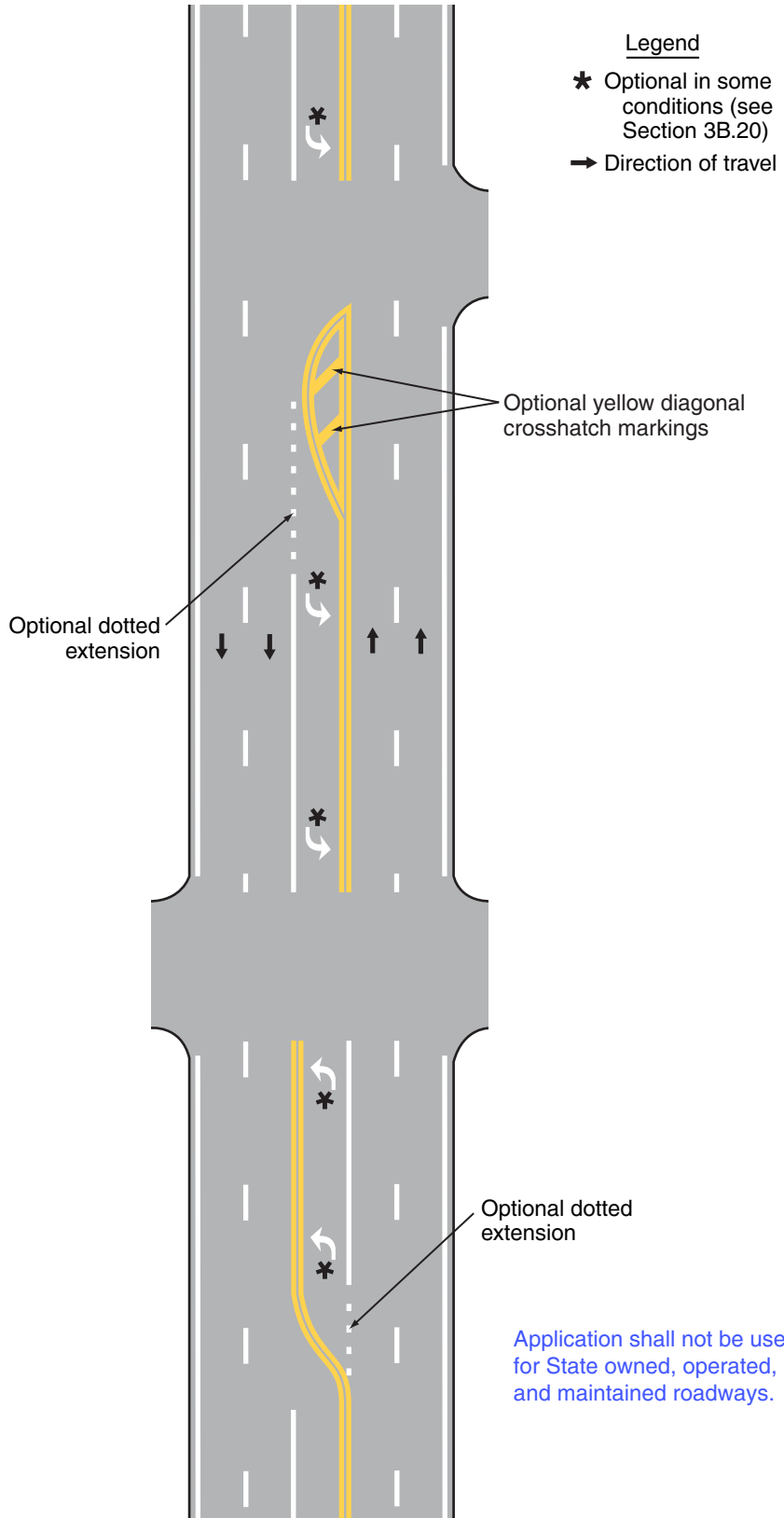
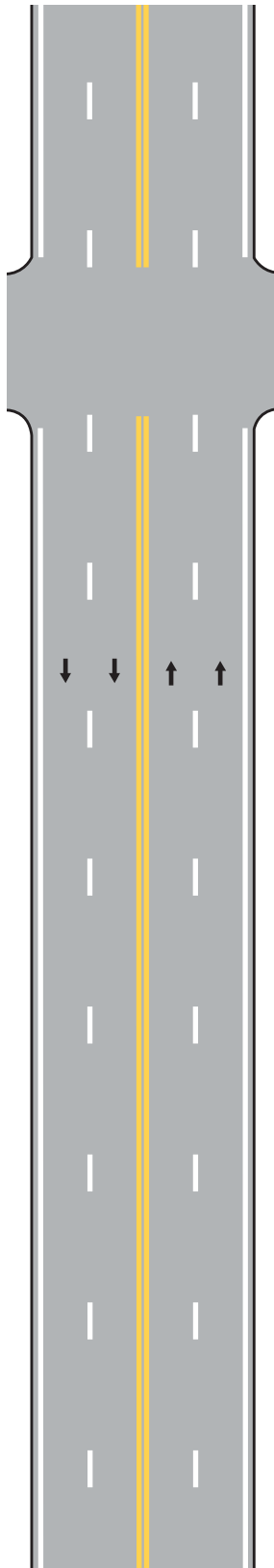
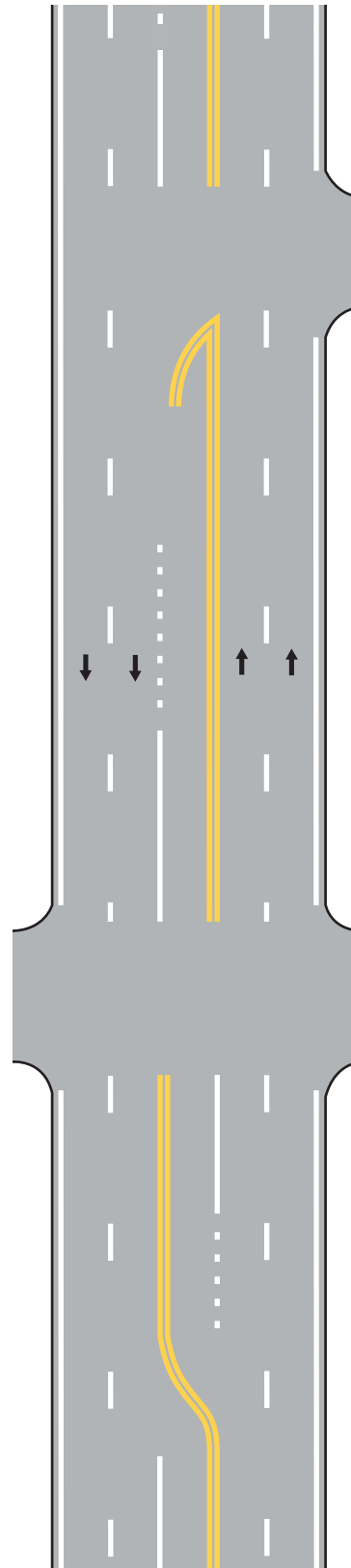

Figure 3B-2a. Examples of Four-or-More Lane, Two-Way Marking Applications Along State Owned, Operated and Maintained Roadways

A - Typical multi-lane, two-way marking



B - Typical multi-lane, two-way marking with single lane left turn channelization



Legend
→ Direction of travel

- Notes:
1. See Section 3B.07 for edge line warrants.
 2. Left turn arrows shall be installed when engineering study determines a need. See Figure 3B-24 for details of Pavement Marking Arrows.

**Figure 3B-2b. Examples of Center Line (Multilane)
- Raised Pavement Markers**

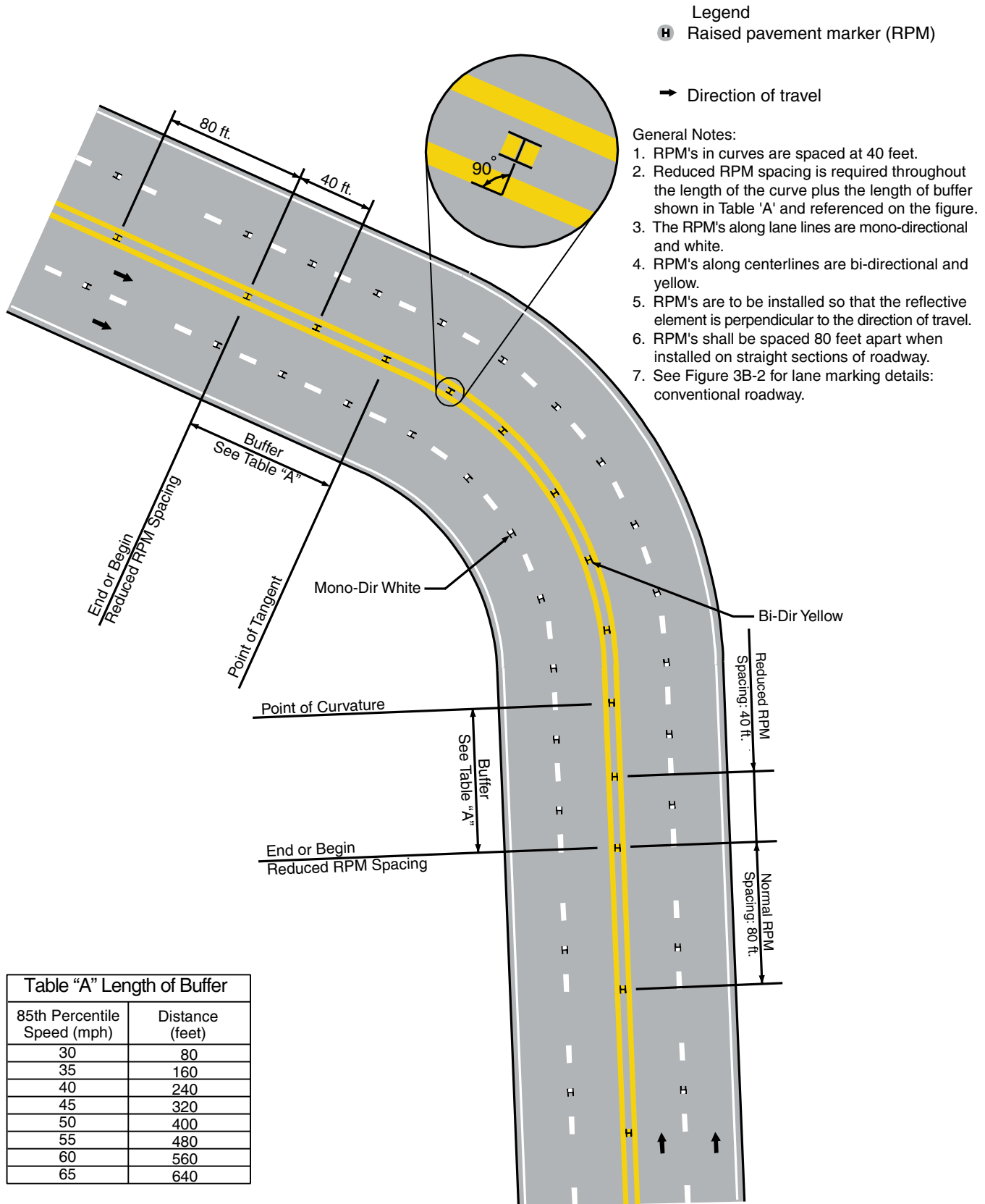

85th Percentile Speed (mph)	Distance (feet)
30	80
35	160
40	240
45	320
50	400
55	480
60	560
65	640

Option:

- 12 Center line markings may be placed on other paved two-way traveled ways that are 16 feet or more in width.
- 13 If a traffic count is not available, the ADTs described in this Section may be estimates that are based on engineering judgment.

Section 3B.02 No-Passing Zone Pavement Markings and Warrants

Standard:

- 01 **No-passing zones shall be marked by either the one direction no-passing zone pavement markings or the two-direction no-passing zone pavement markings described in Section 3B.01 and shown in Figures 3B-1 and 3B-3.**
- 02 **When center line markings are used, no-passing zone markings shall be used on two-way roadways at lane-reduction transitions (see Section 3B.09) and on approaches to obstructions that must be passed on the right (see Section 3B.10).**
- 03 **On two-way, two- or three-lane roadways where center line markings are installed, no-passing zones shall be established at vertical and horizontal curves and other locations where an engineering study indicates that passing must be prohibited because of inadequate sight distances or other special conditions.**
- 04 **On roadways with center line markings, no-passing zone markings shall be used at horizontal or vertical curves where the passing sight distance is less than the minimum shown in Table 3B-1 for the 85th-percentile speed or the posted or statutory speed limit, **whichever is higher**. The passing sight distance on a vertical curve is the distance at which an object 3.5 feet above the pavement surface can be seen from a point 3.5 feet above the pavement (see Figure 3B-4). Similarly, the passing sight distance on a horizontal curve is the distance measured along the center line or right-hand lane line of a three-lane roadway) between two points 3.5 feet above the pavement on a line tangent to the embankment or other obstruction that cuts off the view on the inside of the curve (see Figure 3B-4).**

Figure 3B-3. Examples of Three-Lane, Two-Way Marking Applications

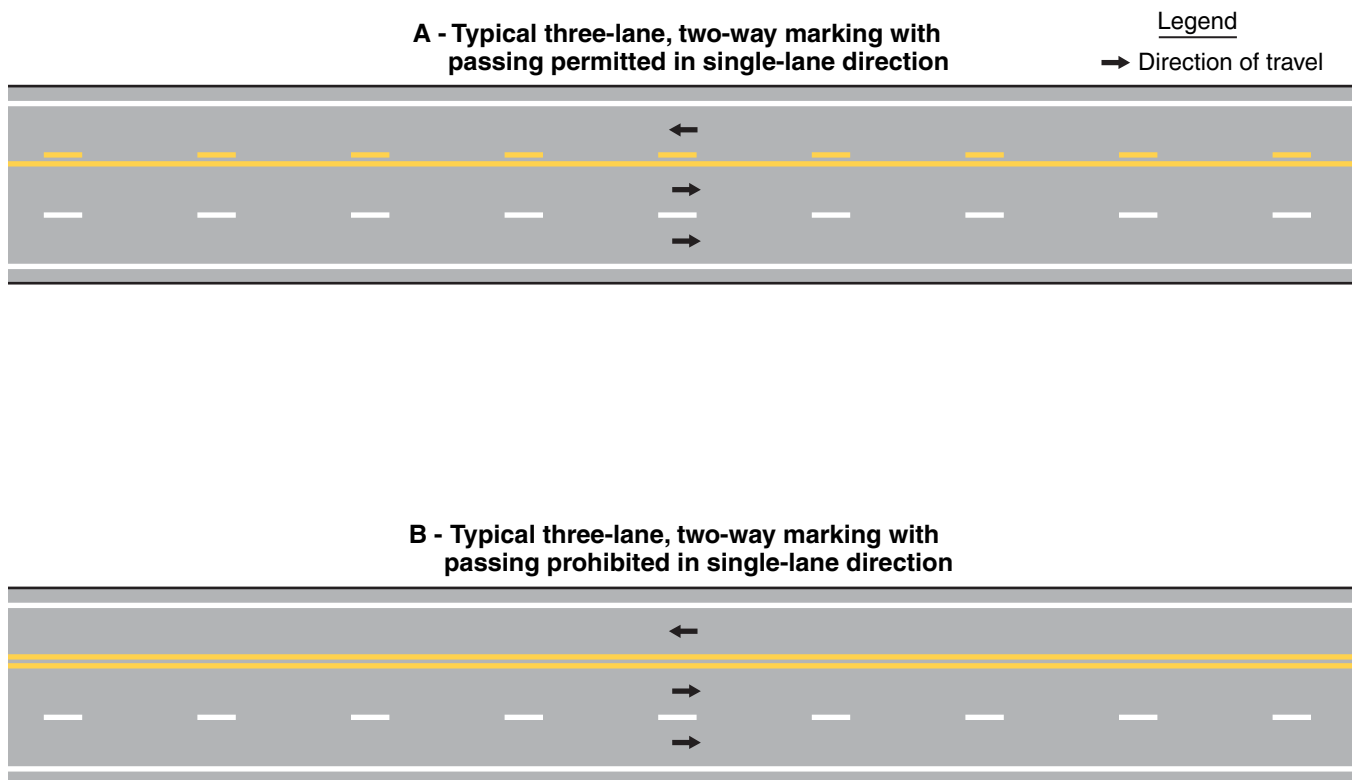

Support:

05 The upstream end of a no-passing zone at point “a” in Figure 3B-4 is that point where the sight distance first becomes less than that specified in Table 3B-1. The downstream end of the no-passing zone at point “b” in Figure 3B-4 is that point at which the sight distance again becomes greater than the minimum specified.

06 The values of the minimum passing sight distances that are shown in Table 3B-1 are for operational use in marking no-passing zones and are less than the values that are suggested for geometric design by the AASHTO Policy on Geometric Design of Streets and Highways (see Section 1A.11).

Guidance:

07 *Where the distance between successive no-passing zones is less than 400 feet, no-passing markings should connect the zones.*

Standard:

08 **Where center line markings are used, no-passing zone markings shall be used on approaches to-grade crossings in compliance with Section 8B.27.**

Option:

09 In addition to pavement markings, no-passing zone signs (see Sections 2B.28, 2B.29, and 2C.45) may be used to emphasize the existence and extent of a no-passing zone.

Support:

10 Section 11-307 of the “Uniform Vehicle Code (UVC)” contains further information regarding required road user behavior in no-passing zones. The UVC can be obtained from the National Committee on Uniform Traffic Laws and Ordinances at the address shown on Page i.

Standard:

11 **On three-lane roadways where the direction of travel in the center lane transitions from one direction to the other, a no-passing buffer zone shall be provided in the center lane as shown in Figure 3B-5. A lane-reduction transition (see Section 3B.09) shall be provided at each end of the buffer zone.**

12 **The buffer zone shall be a flush median island formed by two sets of double yellow center line markings that is at least 50 feet in length.**

Option:

13 Yellow diagonal crosshatch markings (see Section 3B.24) may be placed in the flush median area between the two sets of no-passing zone markings as shown in Figure 3B-5.

Guidance:

14 *For three-lane roadways having a posted or statutory speed limit of 45 mph or greater, the lane transition taper length should be computed by the formula $L = WS$. For roadways where the posted or statutory speed limit is less than 45 mph, the formula $L = WS^2/60$ should be used to compute the taper length.*

Support:

15 Under both formulas, L equals the taper length in feet, W equals the width of the center lane or offset distance in feet, and S equals the 85th-percentile speed or the posted or statutory speed limit, whichever is higher.

Guidance:

16 *The minimum lane transition taper length should be 100 feet in urban areas and 200 feet in rural areas.*

Table 3B-1. Minimum Passing Sight Distances for No-Passing Zone Markings

85th-Percentile or Posted or Statutory Speed Limit	Minimum Passing Sight Distance
25 mph	450 feet
30 mph	500 feet
35 mph	550 feet
40 mph	600 feet
45 mph	700 feet
50 mph	800 feet
55 mph	900 feet
60 mph	1,000 feet
65 mph	1,100 feet
70 mph	1,200 feet

Figure 3B-4. Method of Locating and Determining the Limits of No-Passing Zones at Curves

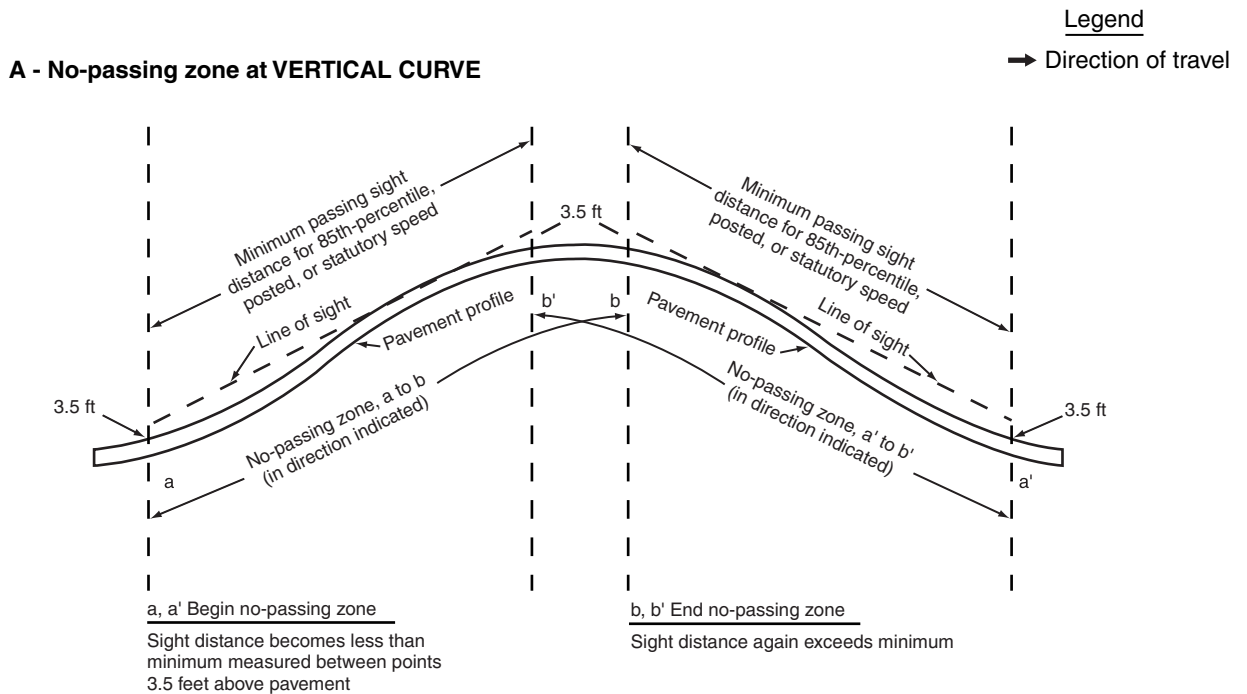

Profile View

Note: No-passing zones in opposite directions may or may not overlap, depending on alignment

B - No-passing zone at HORIZONTAL CURVE

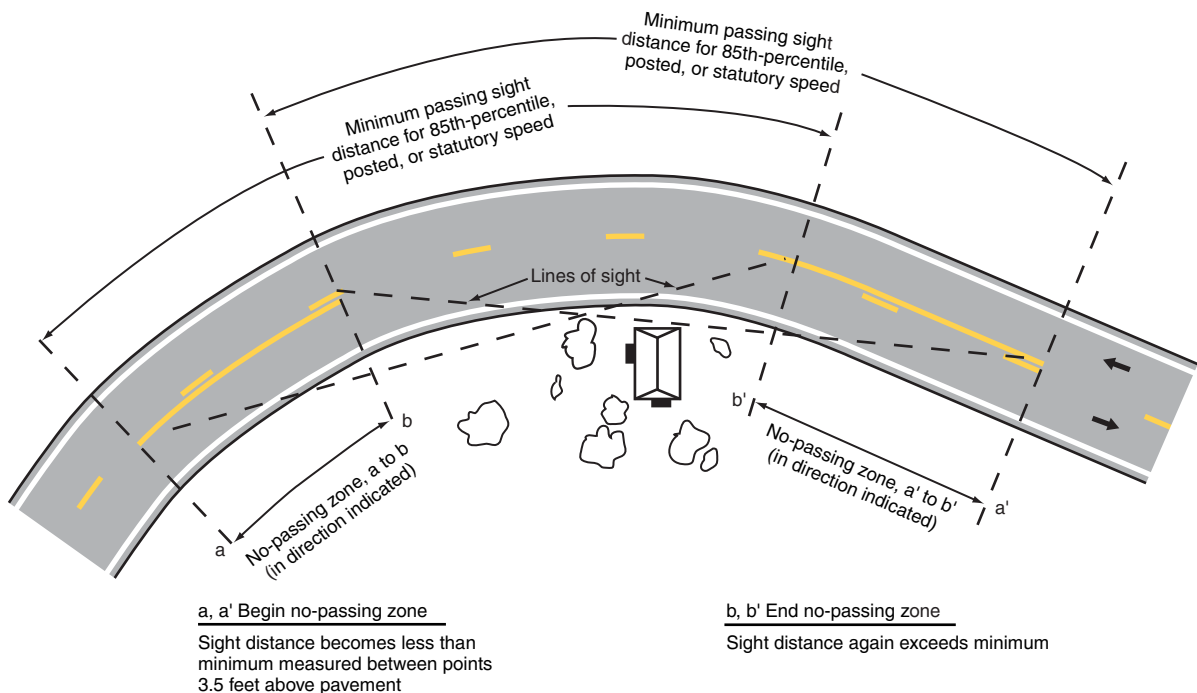

Plan View

Note: No-passing zones in opposite directions may or may not overlap, depending on alignment

Figure 3B-5. Example of Application of Three-Lane, Two-Way Marking for Changing Direction of the Center Lane

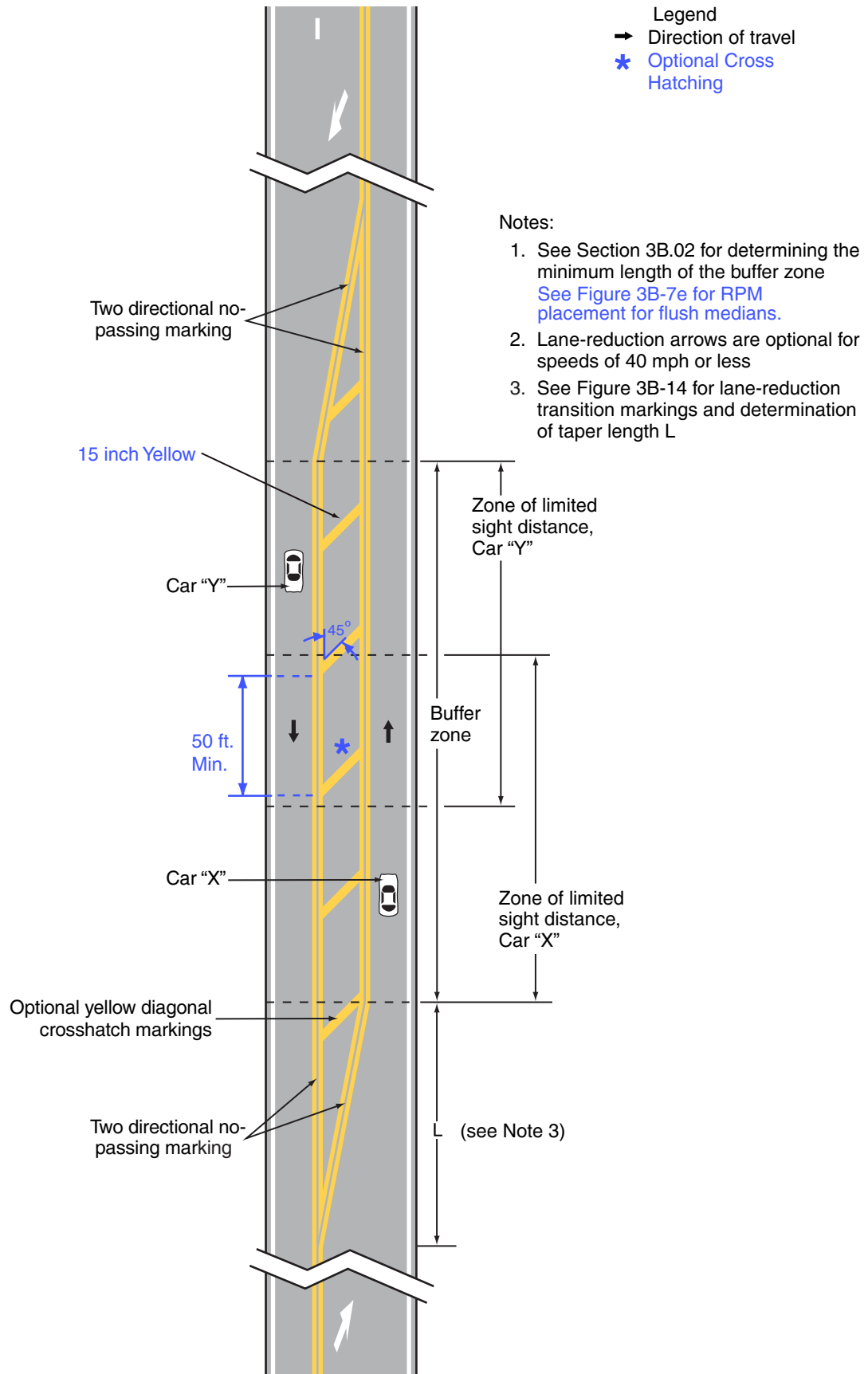

Section 3B.03 Other Yellow Longitudinal Pavement Markings

Standard:

01 If reversible lanes are used, the lane line pavement markings on each side of reversible lanes shall consist of a normal broken double yellow line to delineate the edge of a lane in which the direction of travel is reversed from time to time, such that each of these markings serve as the center line markings of the roadway during some period (see Figure 3B-6).

02 Signs (see Section 2B.26), lane-use control signals (see Chapter 4M), or both shall be used to supplement reversible lane pavement markings.

03 If a two-way left-turn lane that is never operated as a reversible lane is used, the lane line pavement markings on each side of the two-way left-turn lane shall consist of a normal broken yellow line and a normal solid yellow line to delineate the edges of a lane that can be used by traffic in either direction as part of a left-turn maneuver. These markings shall be placed with the broken line toward the two-way left-turn lane and the solid line toward the adjacent traffic lane as shown in Figure 3B-7.

03a On State owned and operated intersections, when an exclusive left turn segment is inserted within a two-way left turn system, at least one left turn arrow shall be used to indicate the nature of that segment. The word "ONLY" shall not be used. See Figure 3B-7a for details.

Guidance:

04 White two-way left-turn lane-use arrows (see Figure 3B-7), should be used in conjunction with the longitudinal two-way left-turn markings at the locations described in Section 3B.20.

04a Raised pavement markers, when used in left turn lane with two-way center left turn, should conform to Figure 3B-7b.

05 Signs should be used in conjunction with the two-way left turn markings (see Section 2B.24).

Standard:

06 If a continuous flush median island formed by pavement markings separating travel in opposite directions is used, two sets of solid double yellow lines shall be used to form the island as shown in Figures 3B-2 and 3B-5. Other markings in the median island area shall also be yellow, except crosswalk markings which shall be white (see Section 3B.18).

Section 3B.04 White Lane Line Pavement Markings and Warrants

Standard:

01 When used, lane line pavement markings delineating the separation of traffic lanes that have the same direction of travel shall be white.

02 Lane line markings shall be used on all freeways and Interstate highways.

02a Lane lines between adjacent traffic lanes shall be continued right up to the stop line as shown in figures in Chapter 3B.

Guidance:

03 Lane line markings should be used on all roadways that are intended to operate with two or more adjacent traffic lane in the same direction of travel, except as otherwise required for reversible lanes. Lane line markings should also be used at congested locations where the roadway will accommodate more traffic lanes with lane line markings than without the markings.

Figure 3B-6. Example of Reversible Lane Marking Application

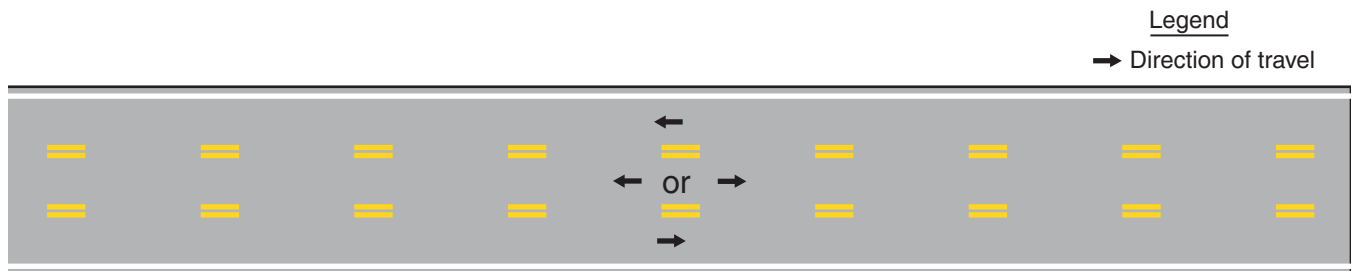

Support:

04 Examples of lane line markings and raised pavement markers are shown in Figures 3B-2, 3B-3, and 3B-7 through 3B-13.

Standard:

05 Except as provided in Paragraph 6, where crossing the lane line markings with care is permitted, the lane line markings shall consist of a normal broken white line.

06 A dotted white line marking shall be used as the lane line to separate a through lane that continues beyond the interchange or intersection from an adjacent lane for any of the following conditions:

- A. A deceleration or acceleration lane,
- B. A through lane that becomes a mandatory exit or turn lane,
- C. An auxiliary lane 2 miles or less in length between an entrance ramp and an exit ramp, or
- D. An auxiliary lane 1 mile or less in length between two adjacent intersections.

07 For exit ramps with a parallel deceleration lane, a wide width dotted white lane line shall be installed from the upstream end of the full-width deceleration lane to the theoretical gore or to the upstream end of a solid white lane line, if used, that extends upstream from the theoretical gore as shown in Drawings A and E of Figure 3B-8.

Guidance:

07a Lane lines should not be converted to solid lines approaching intersections except in critical areas where it is advisable to discourage lane changing. However, a single solid white line should be used to separate a turn lane from the through-traffic lanes as also shown in figures in Chapter 3B.

07b Lane lines should not be placed on construction joints. Reference the SHA Pavement Marking Manual which can be obtained from the Maryland State Highway Administration's Office of Traffic & Safety, Traffic Engineering Design Division (TEDD) at the address shown on Page i.

Option:

08 For exit ramps with a parallel deceleration lane, a wide width dotted white line extension may be installed in the taper area upstream from the full-width deceleration lane as shown in Drawings A and E of Figure 3B-8.

09 For an exit ramp with a tapered deceleration lane, a wide width dotted white line extension may be installed from the theoretical gore through the taper area such that it meets the edge line at the upstream end of the taper as shown in Drawing C of Figure 3B-8.

Standard:

10 For entrance ramps with a parallel acceleration lane, a wide width dotted white lane line shall be installed from the theoretical gore or from the downstream end of a solid white lane line, if used, that extends downstream from the theoretical gore, to the upstream end of the acceleration taper, as shown in Drawing A of Figure 3B-9.

Option:

11 For entrance ramps with a parallel acceleration lane, a wide width dotted white line extension may be installed from the downstream end of the solid white lane line to the downstream end of the acceleration taper, as shown in Drawing A of Figure 3B-9.

12 For entrance ramps with a tapered acceleration lane, a wide width dotted white line extension may be installed from the downstream end of the channelizing line adjacent to the through lane to the downstream end of the acceleration taper, as shown in Drawings C and E of Figure 3B-9.

Standard:

13 A wide dotted white lane line shall be used:

- A. As a lane drop marking in advance of lane drops at exit ramps to distinguish a lane drop from a normal exit ramp (see Drawings A, C, and E of Figure 3B-10),
- B. In advance of freeway route splits with dedicated lanes (see Drawing G of Figure 3B-10),
- C. To separate a through lane that continues beyond an interchange from an adjacent auxiliary lane between an entrance ramp and an exit ramp (see Drawing I of Figure 3B-10),
- D. As a lane drop marking in advance of lane drops at intersections to distinguish a lane drop from an intersection through lane (see Drawing A of Figure 3B-11), and
- E. To separate a through lane that continues beyond an intersection from an adjacent auxiliary lane between two intersections (see Drawing B of Figure 3B-11).

Figure 3B-7. Example of Two-Way Left-Turn Lane Marking Applications

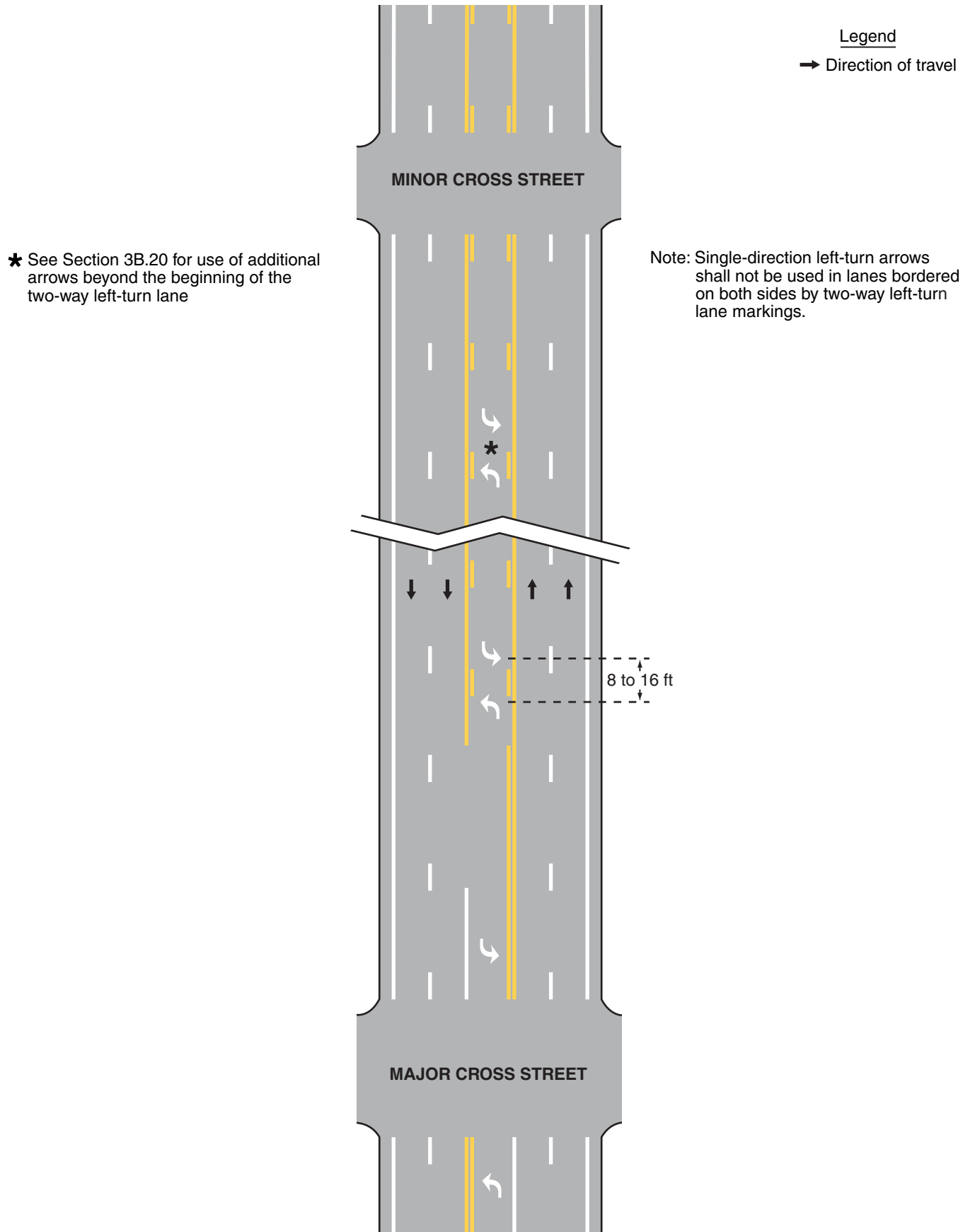

Figure 3B-7a. Examples of Combination Lane and Centerline Markings - Two-way Left Turn Lane

- Legend
- Direction of travel
 - ↻ Lane Use Arrows
 - ⊣ Sign
 - * Optional

General Notes:

1. R3-9 Series signs shall be used in conjunction with 2-way left turn pavement marking arrows.
2. Exclusive left turn arrow markings shall be used for major left turn bays.
3. One set of arrows shall be placed on each approach to all major intersecting streets. The arrow shall be placed 50 feet beyond the beginning of the full width marked double yellow centerline.
4. See Section 3B.11 to 3B.14 for RPM standards.

See Figure 3B-27f for Turn Bay Pavement Marking

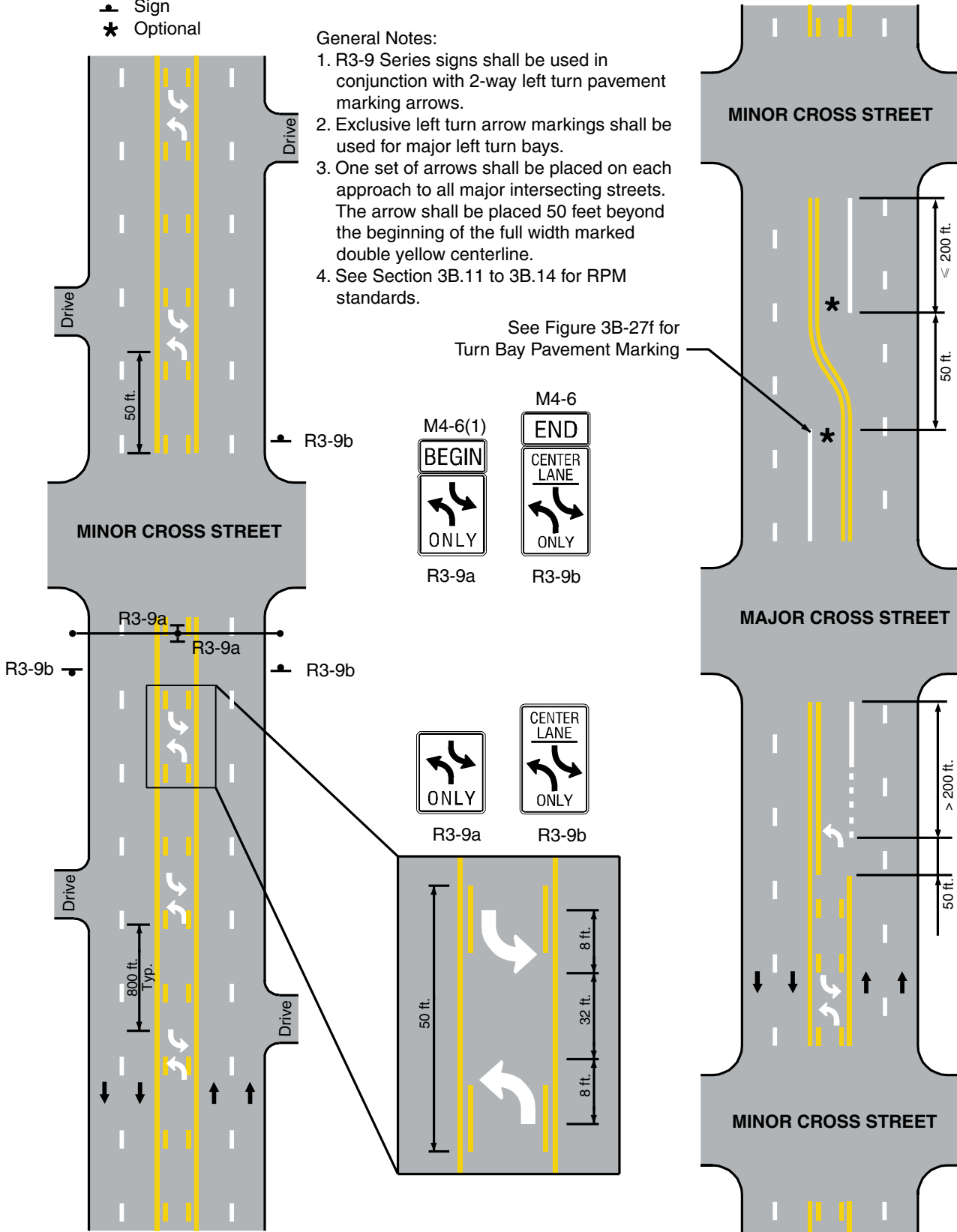
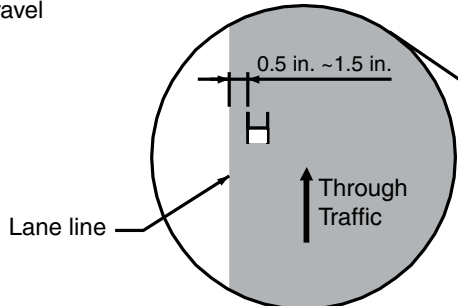

Figure 3B-7b. Examples of Left Turn Lane with Two-way Center Left Turn - Raised Pavement Markers.

- Legend
- Ⓜ Raised pavement marker (RPM)
 - ➔ Direction of travel



85th Percentile Speed (mph)	Distance (feet)
30	80
35	160
40	240
45	320
50	400
55	480
60	560
65	640

See Figure 3A-1a for Spacing of Type I Dotted Line

Mono-Dir White

Bi-Dir Yellow

General Notes:

1. RPM's reflector types as shown.
2. All RPM's are to be installed so that the reflective element is perpendicular to through traffic (see inset).
3. RPM's supplementing the double yellow solid /dash center line are to be installed between the solid double lines or extension thereof.
4. RPM's supplementing the yellow center line along the left turn lane are to be spaced 20 feet apart for the entire length of the turn lane if equal to or less than 200 feet. If the turn lane is greater than 200 feet then RPM's are to be spaced at 40 feet throughout.
5. If used, RPM's shall extend back from the left turn bay a distance as shown on Table "A".
6. See Section 3B.11 through 3B.14 for RPM standards.
7. If used, RPM's shall continue to the stop line.

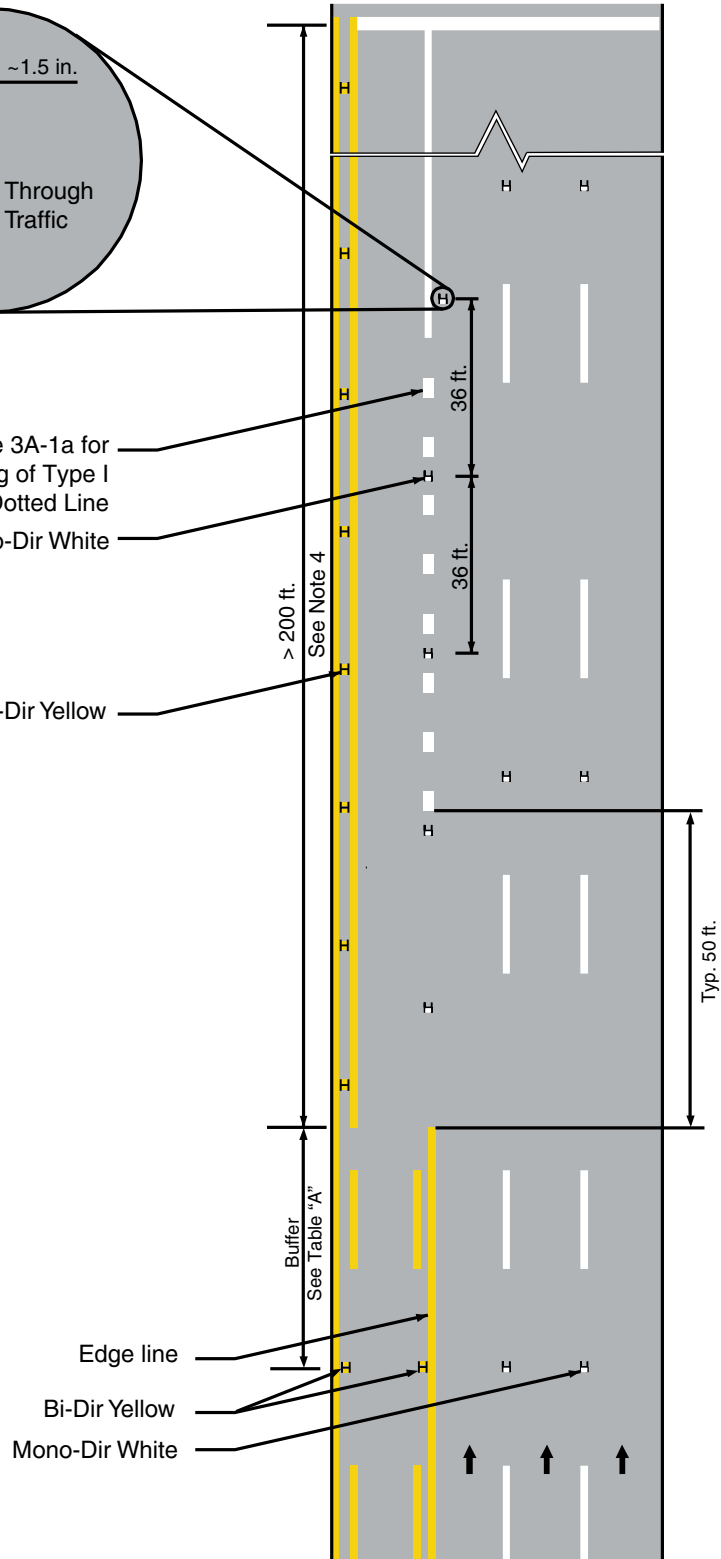

Figure 3B-7c. Examples of Raised Pavement Markers

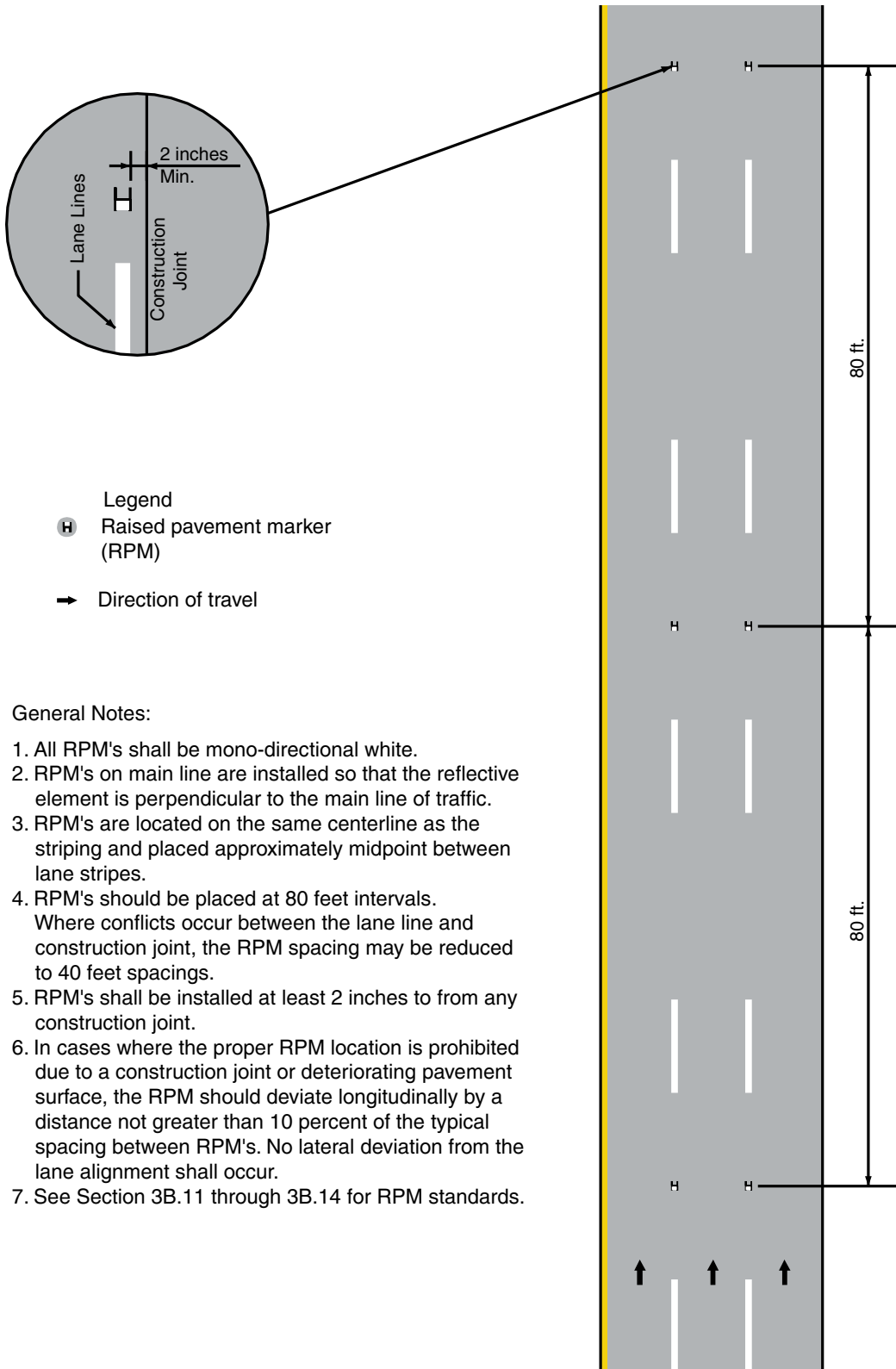

Figure 3B-7d. Examples of Left Turn Lane - Raised Pavement Markers.

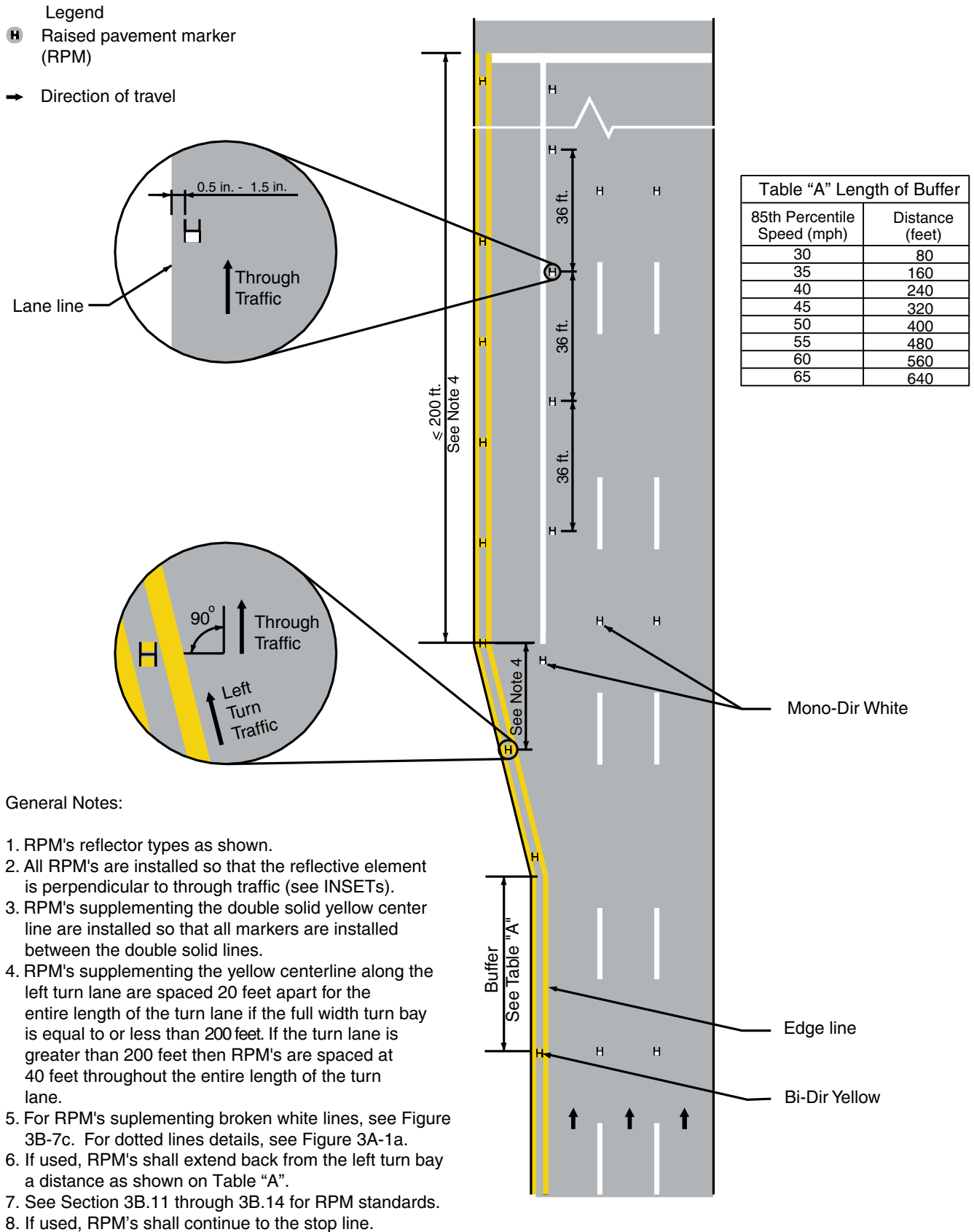
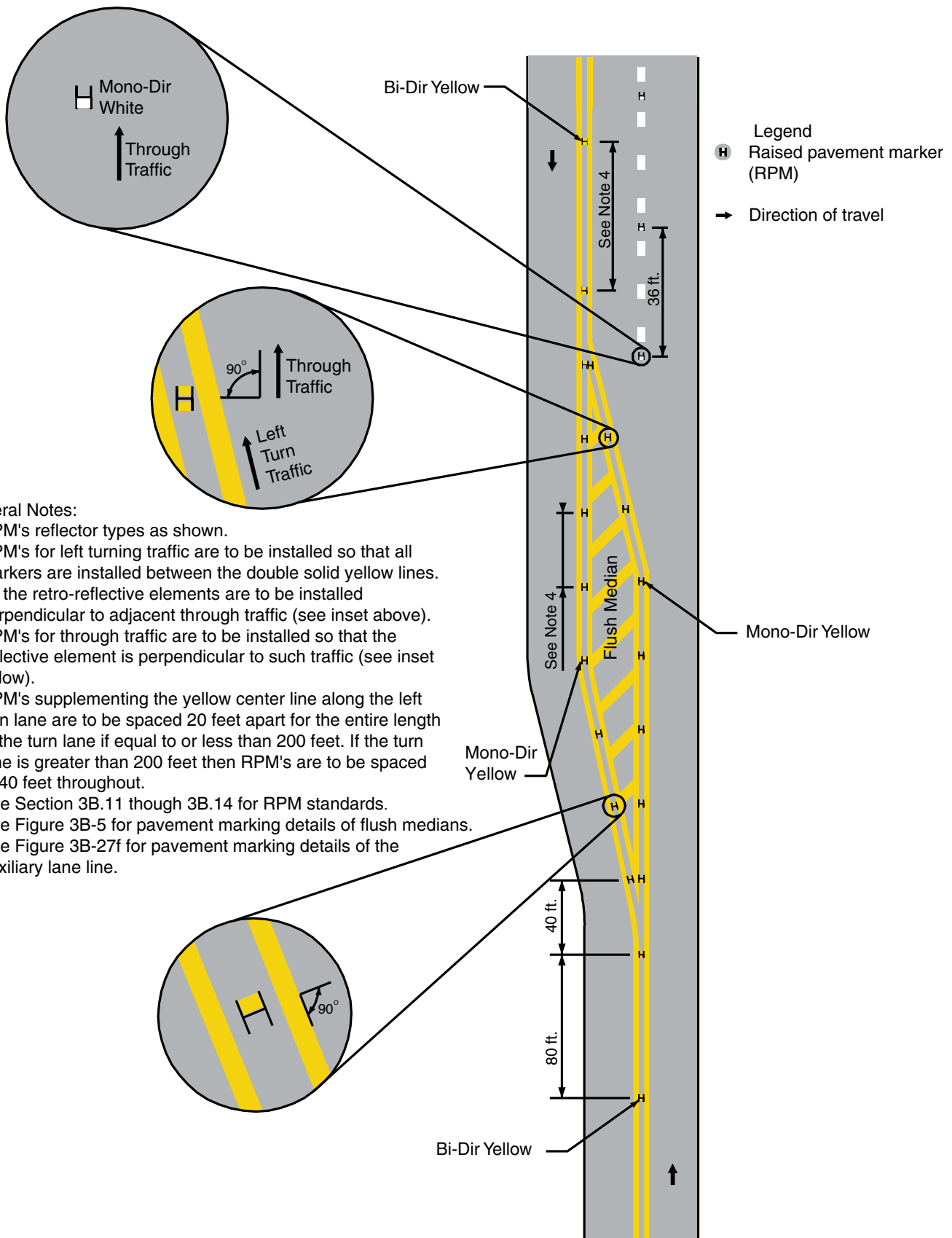

Figure 3B-7e. Examples of Left Turn Lane (Flush Median) - Raised Pavement Markers.



General Notes:

1. RPM's reflector types as shown.
2. RPM's for left turning traffic are to be installed so that all markers are installed between the double solid yellow lines. All the retro-reflective elements are to be installed perpendicular to adjacent through traffic (see inset above).
3. RPM's for through traffic are to be installed so that the reflective element is perpendicular to such traffic (see inset below).
4. RPM's supplementing the yellow center line along the left turn lane are to be spaced 20 feet apart for the entire length of the turn lane if equal to or less than 200 feet. If the turn lane is greater than 200 feet then RPM's are to be spaced at 40 feet throughout.
5. See Section 3B.11 through 3B.14 for RPM standards.
6. See Figure 3B-5 for pavement marking details of flush medians.
7. See Figure 3B-27f for pavement marking details of the auxiliary lane line.

**Figure 3B-7f. Examples of Auxiliary Lane Lines
- By-pass Lane.**

Departure Taper L:
 For $S \leq 45$ mph, $L = W(S-10)^2 / 60$
 For $S > 45$ mph, $L = W(S-10)$
 W = Lane Width (ft)
 S = 85th percentile Prevailing Speed (mph)

* The length of the auxiliary lane should be determined by referencing the latest edition of AASHTO's "A Policy on Geometric Design of Highways and Streets".

- (A) 5 inch white
- (B) 5 inch double yellow
- (C) See Figure 3A-1a for spacing of Type I Dotted Lines

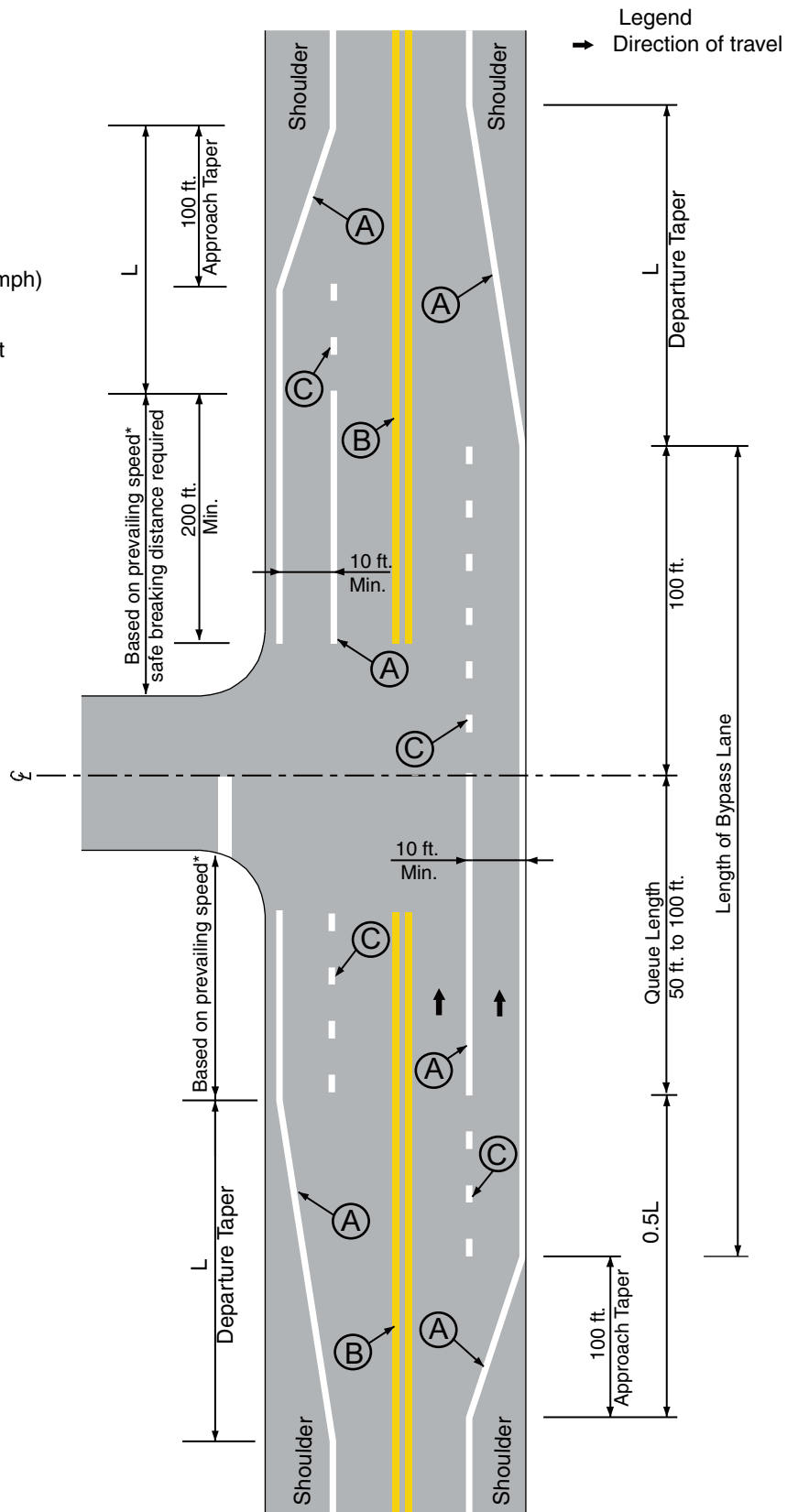

Figure 3B-8. Examples of Dotted Line and Channelizing Line Applications for Exit Ramp Markings (Sheet 1 of 6)

A - Parallel deceleration lane

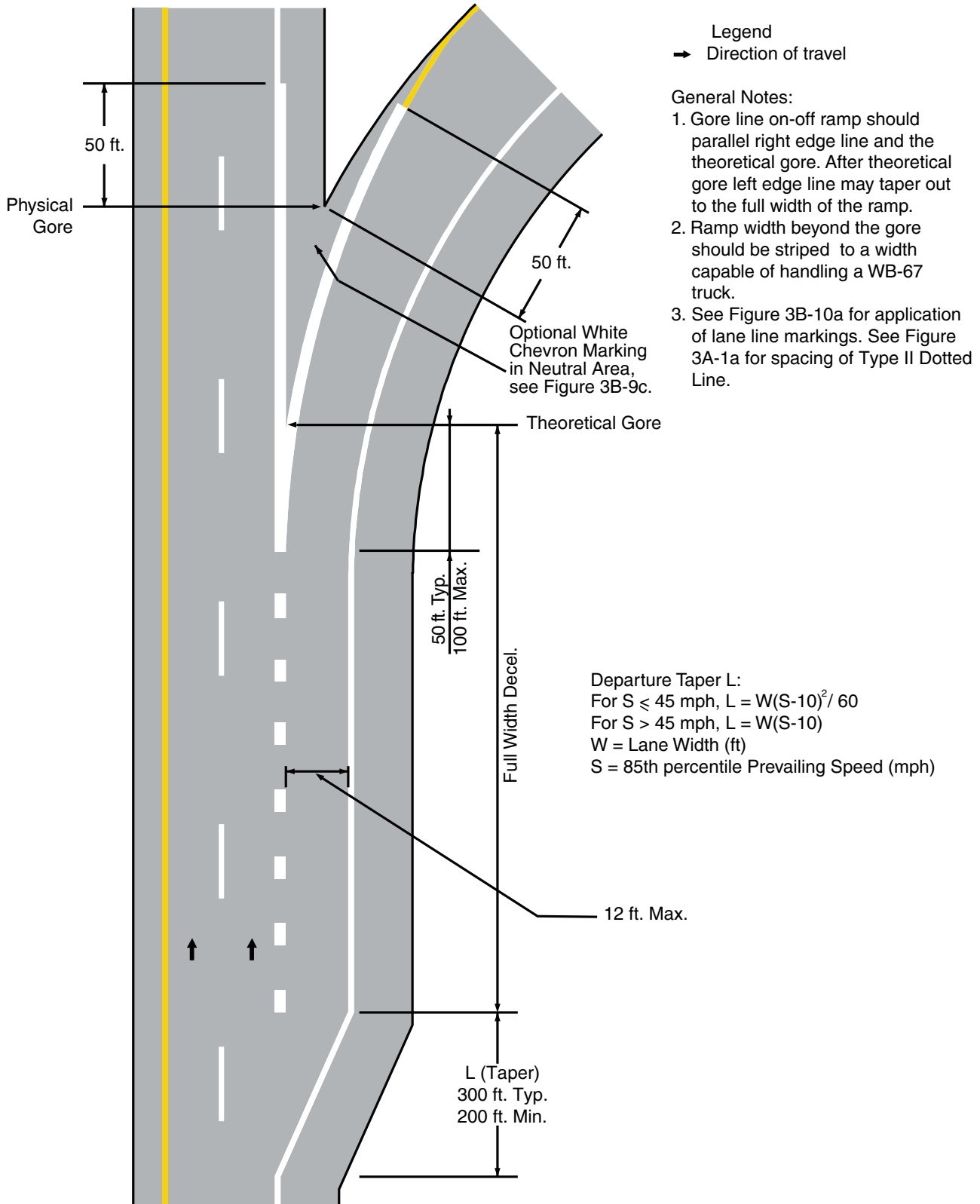

Figure 3B-8. Examples of Dotted Line and Channelizing Line Applications for Exit Ramp Markings (Sheet 2 of 6)

B - Parallel deceleration lane - Raised Pavement Markers

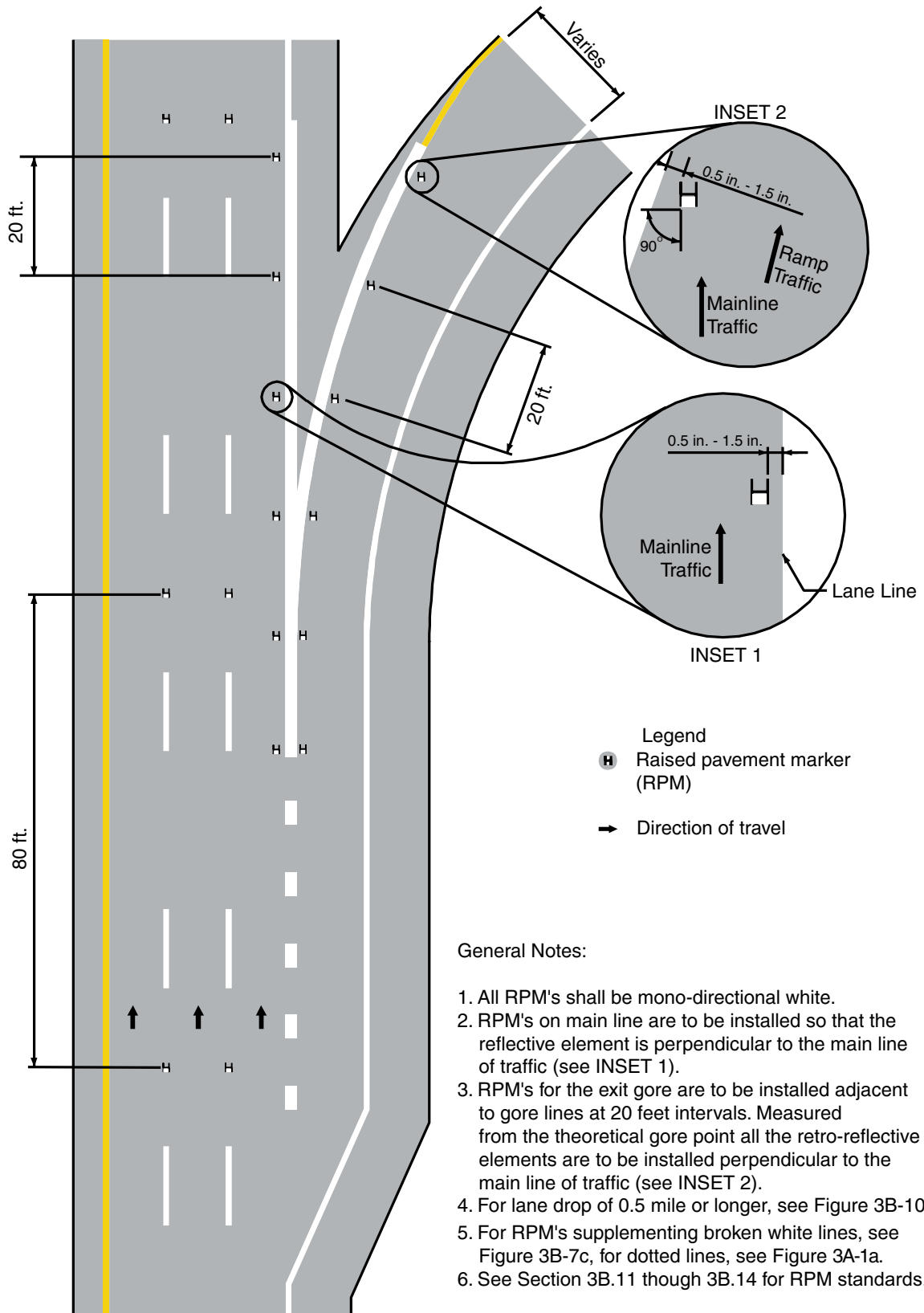

Figure 3B-8. Examples of Dotted Line and Channelizing Line Applications for Exit Ramp Markings (Sheet 3 of 6)

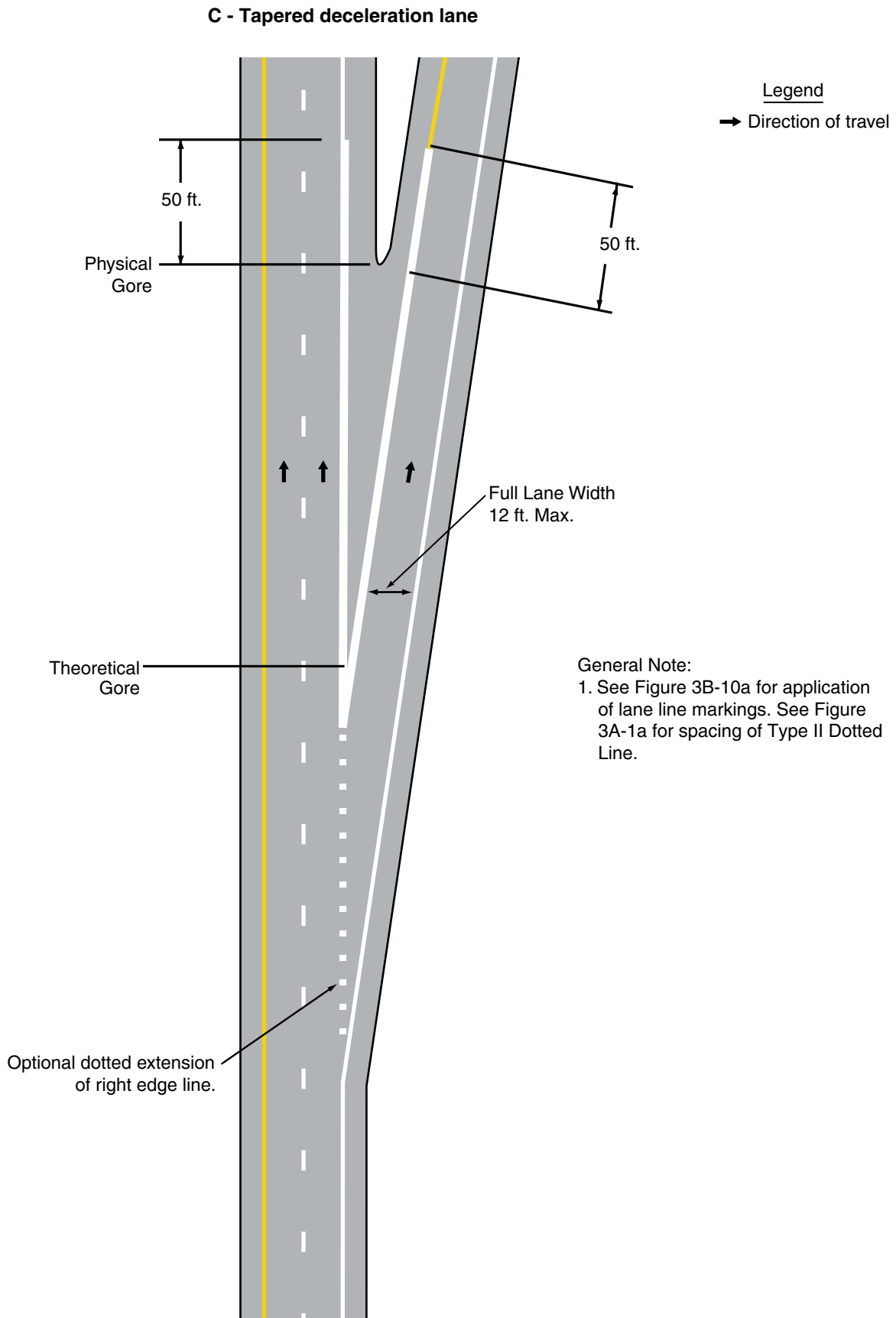

Figure 3B-8. Examples of Dotted Line and Channelizing Line Applications for Exit Ramp Markings (Sheet 4 of 6)

D - Tapered deceleration lane - Raised Pavement Markers

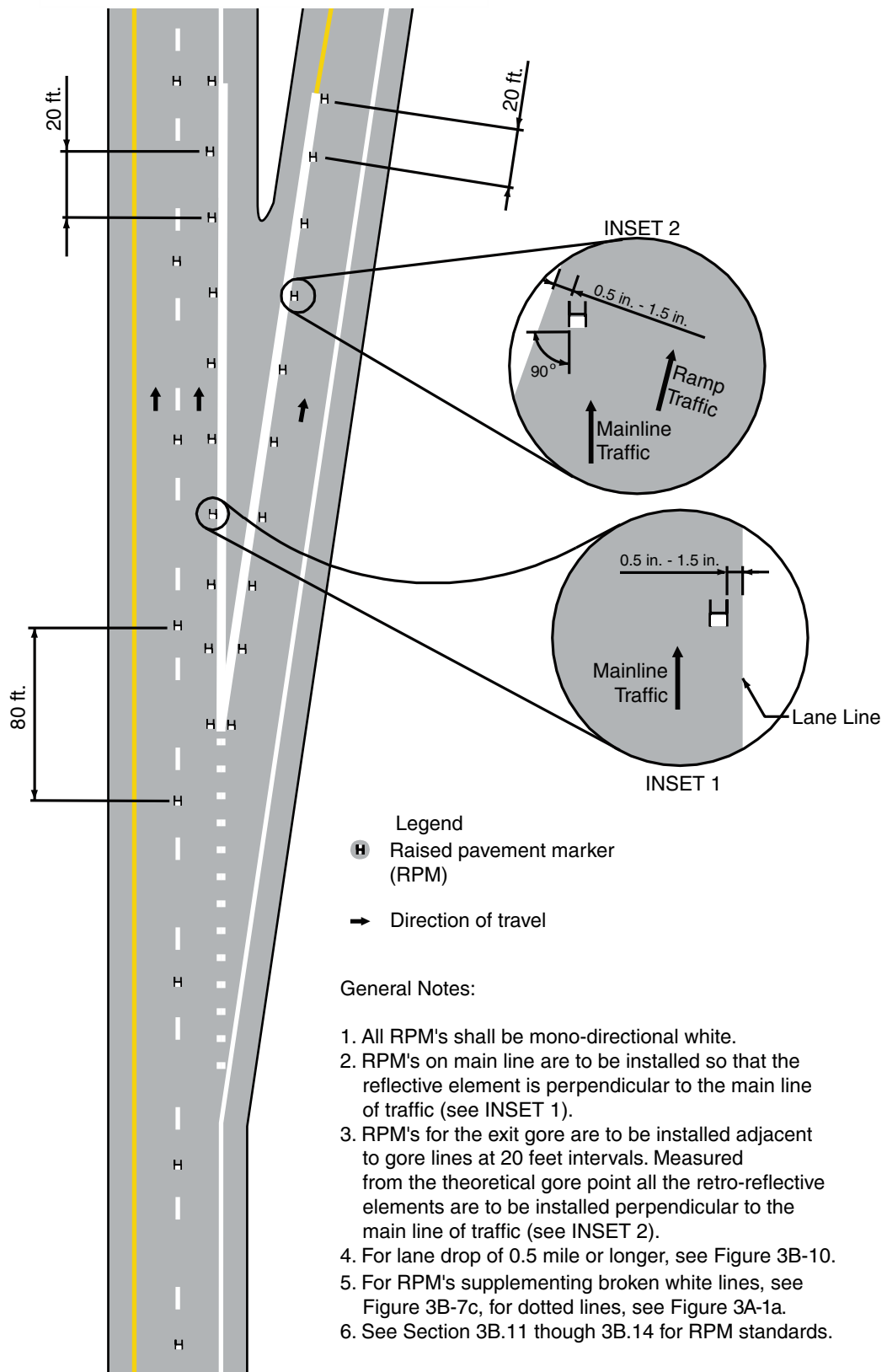

Figure 3B-8. Examples of Dotted Line and Channelizing Line Applications for Exit Ramp Markings (Sheet 5 of 6)

E - Parallel deceleration lane at a multi-lane exit ramp having an optional exit lane that also carries the through route

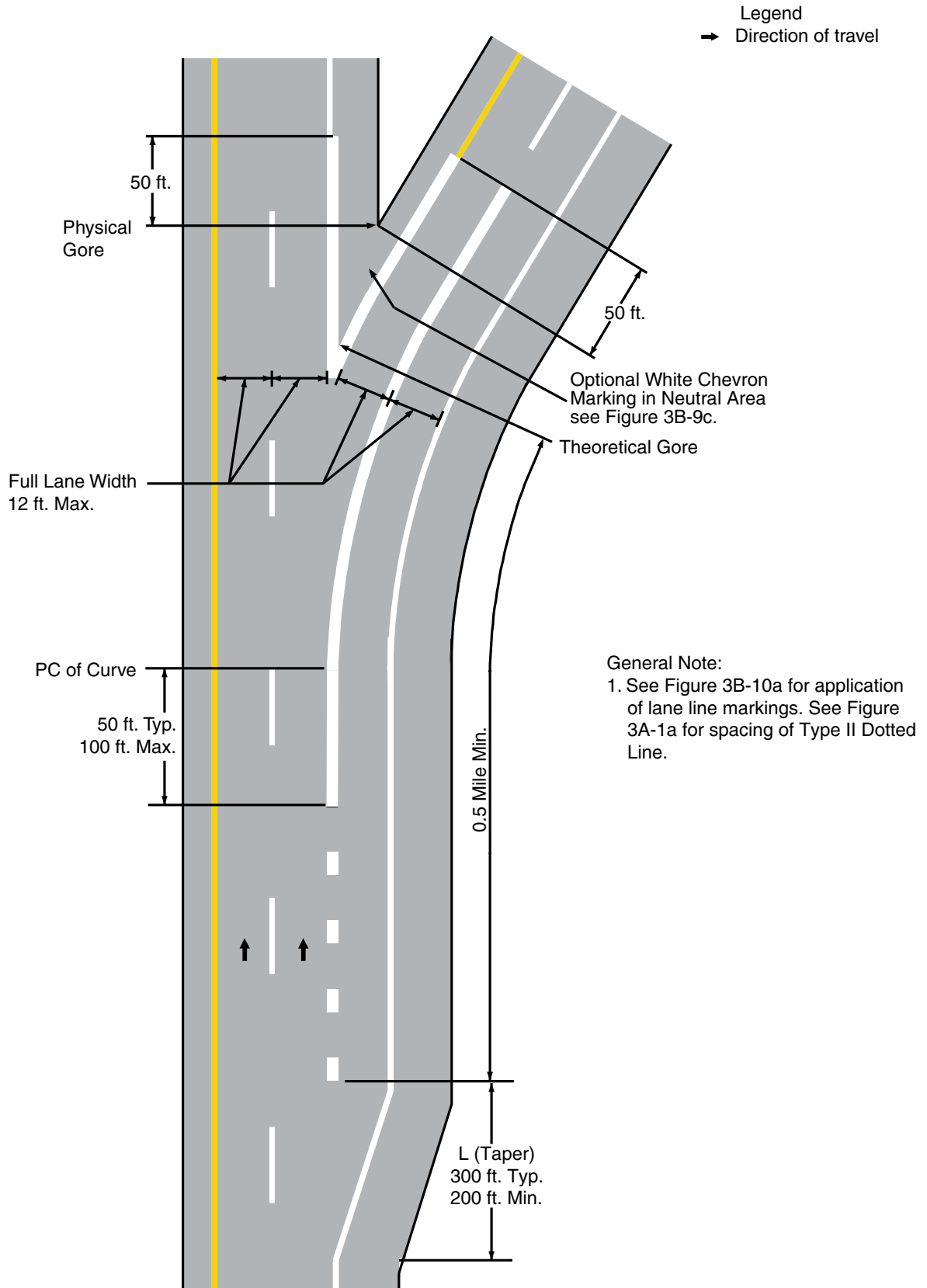

Figure 3B-8. Examples of Dotted Line and Channelizing Line Applications for Exit Ramp Markings (Sheet 6 of 6)

F - Parallel deceleration lane at a multi-lane exit ramp having an optional exit lane that also carries the through route - Raised Pavement Markers

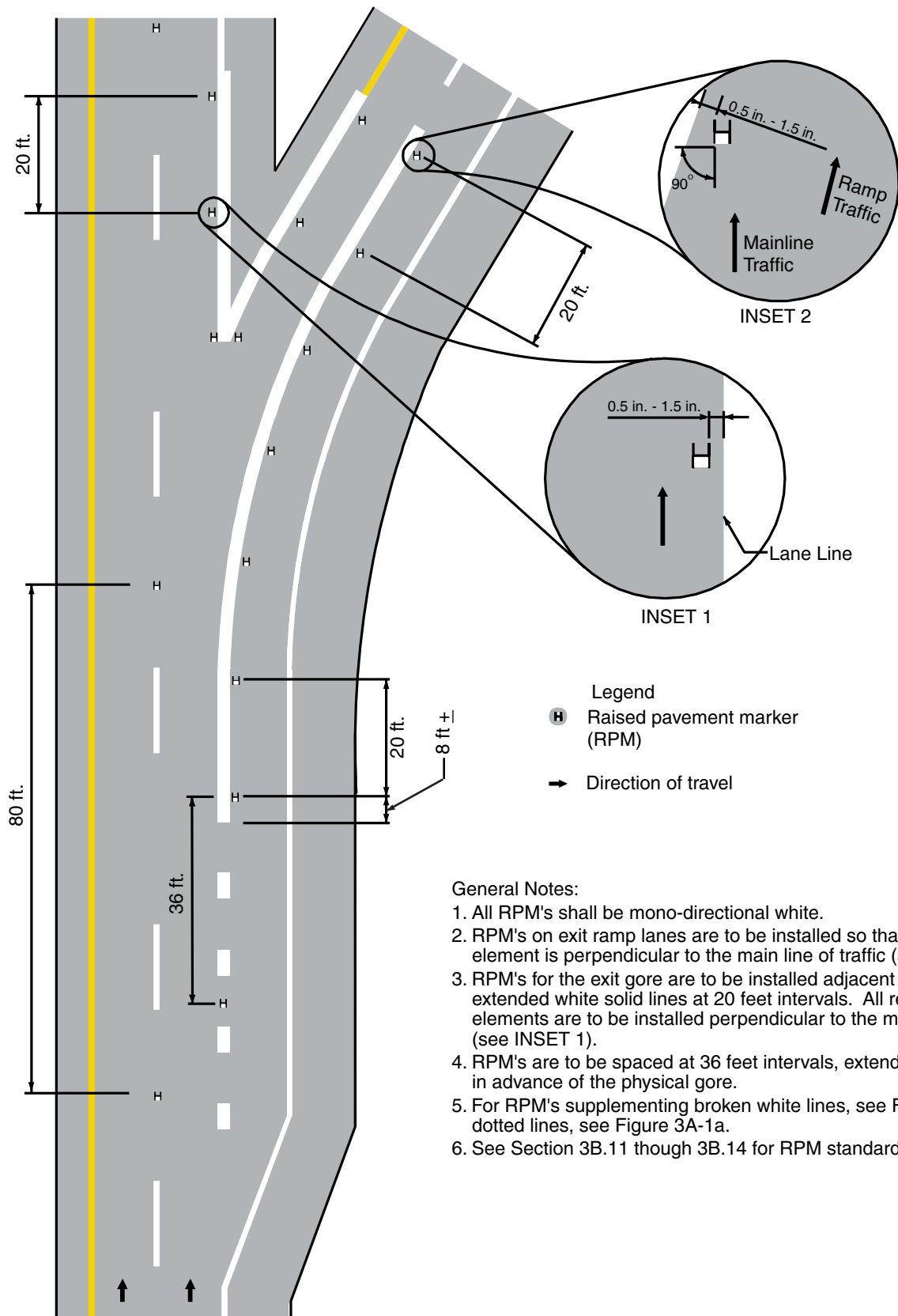

Figure 3B-9. Examples of Dotted Line and Channelizing Line Applications for Entrance Ramp Markings (Sheet 1 of 6)

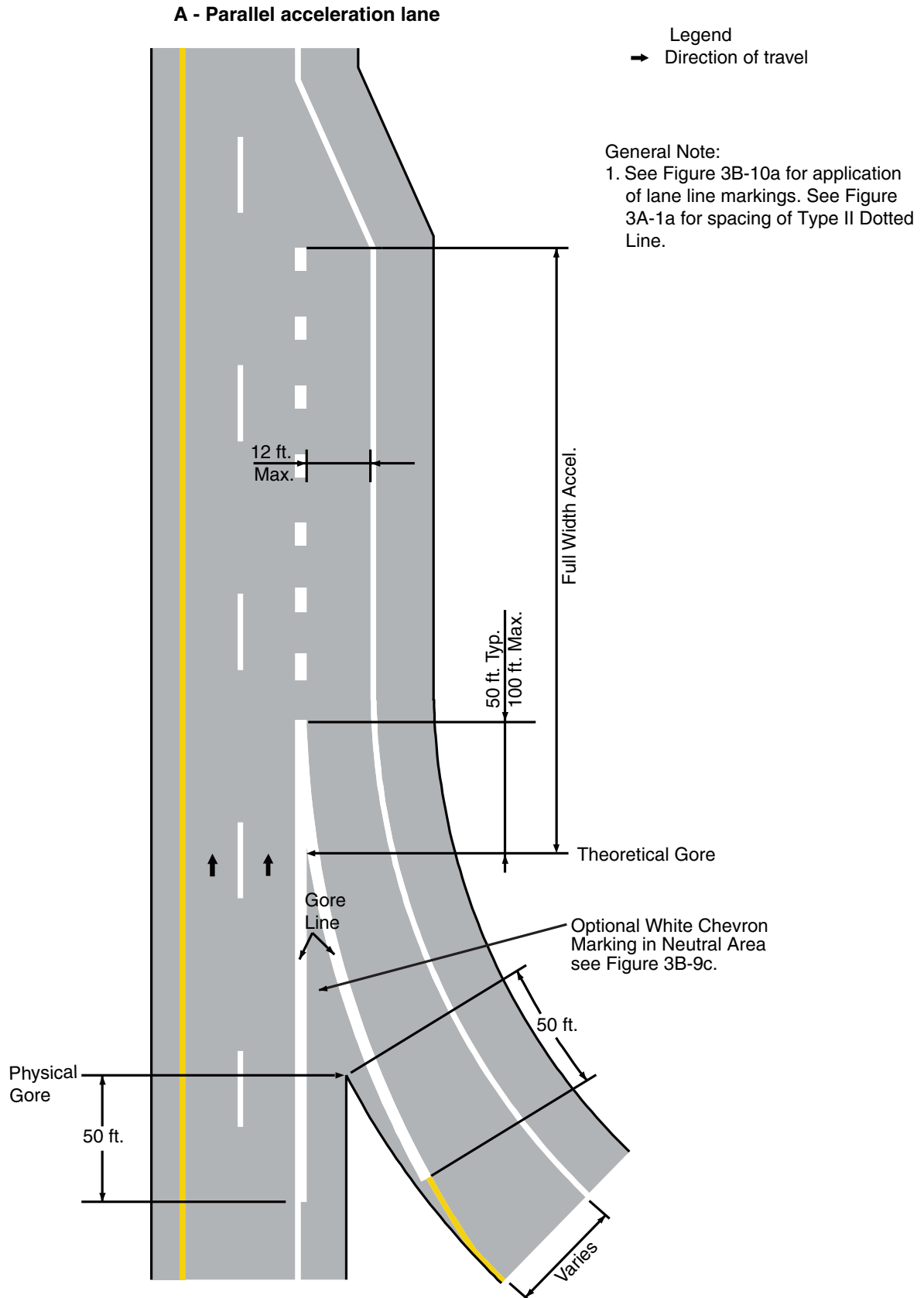

Figure 3B-9. Examples of Dotted Line and Channelizing Line Applications for Entrance Ramp Markings (Sheet 2 of 6)

B - Parallel acceleration lane - Raised Pavement Markers

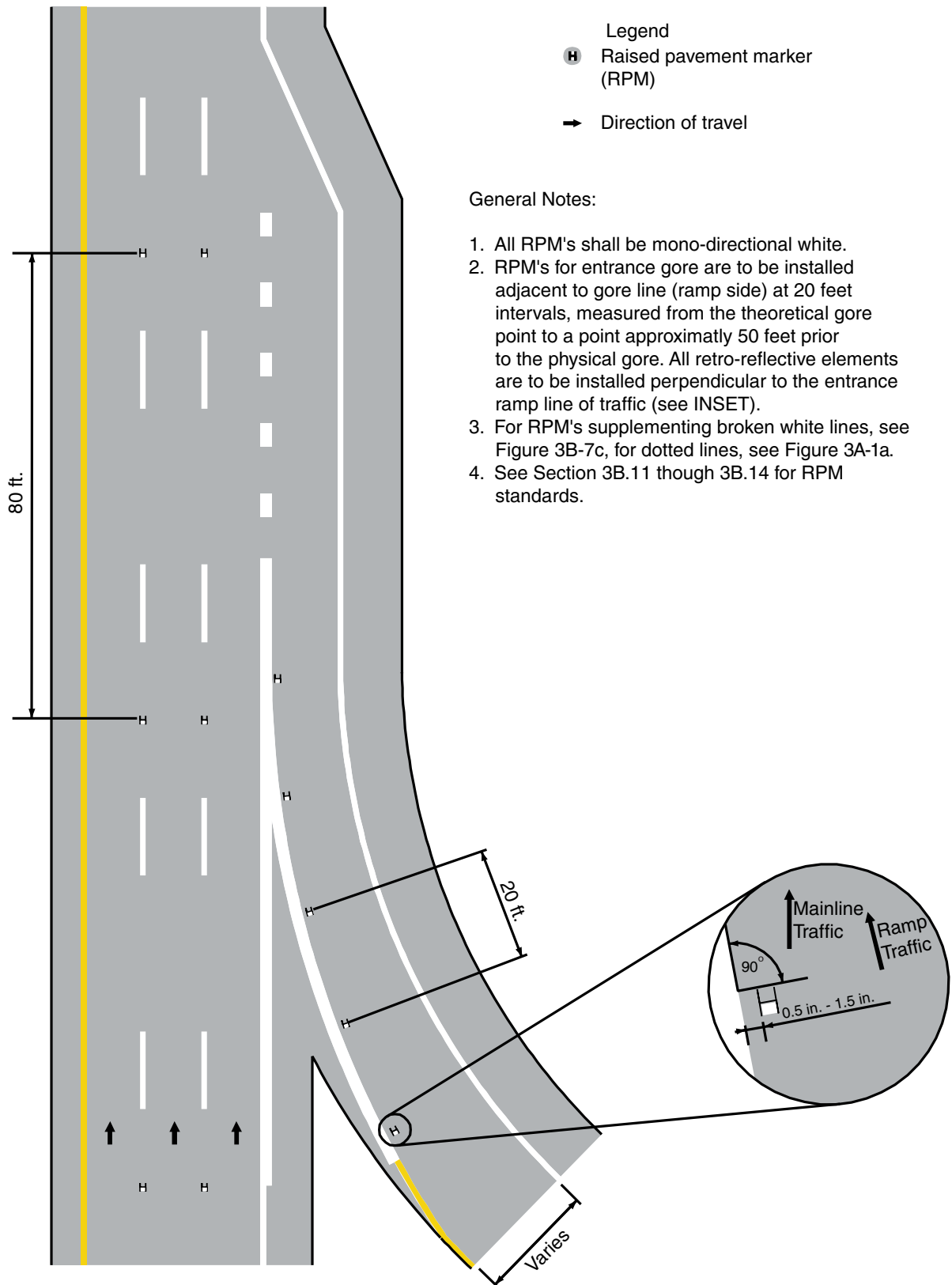

Figure 3B-9. Examples of Dotted Line and Channelizing Line Applications for Entrance Ramp Markings (Sheet 3 of 6)

C - Tapered acceleration lane

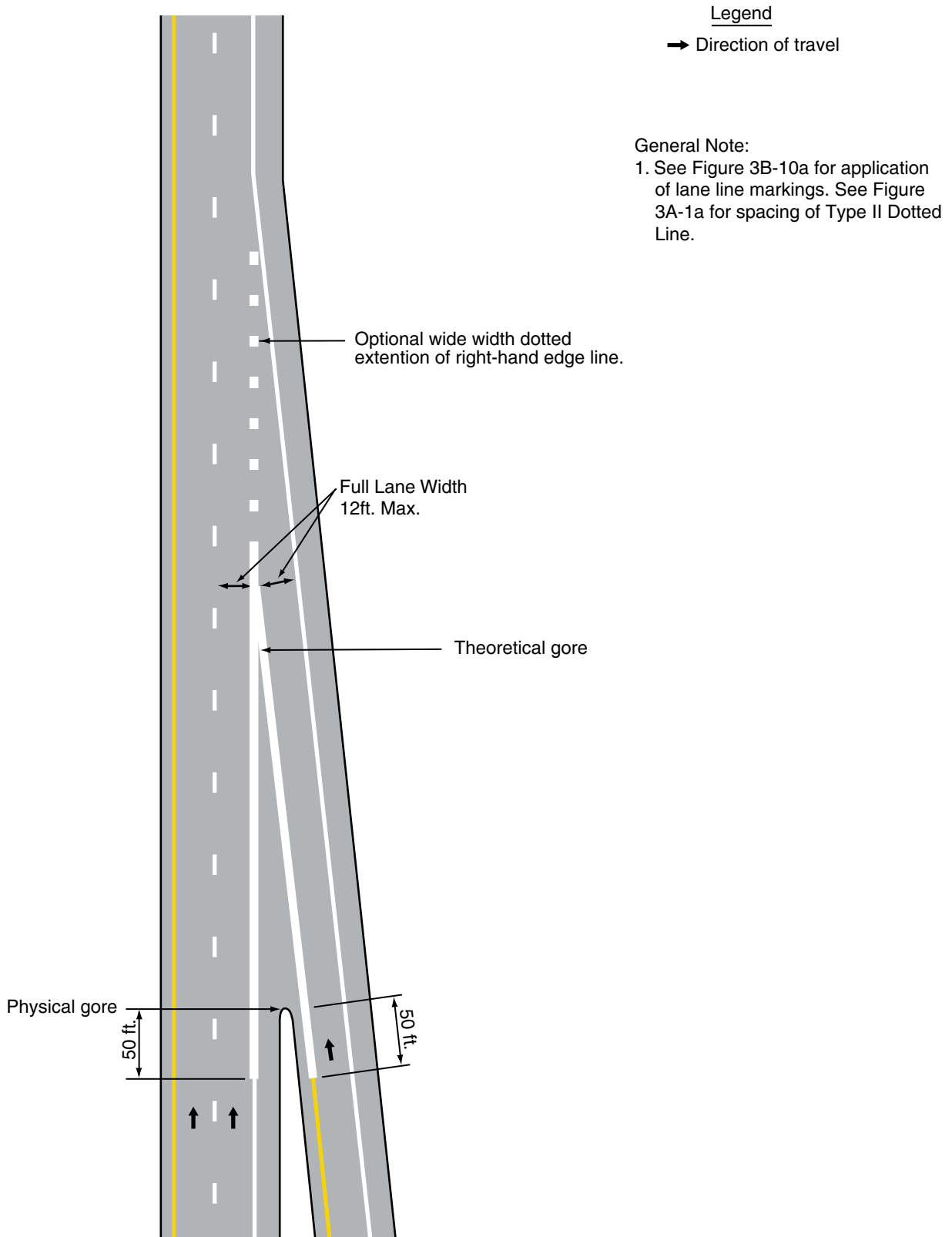

Figure 3B-9. Examples of Dotted Line and Channelizing Line Applications for Entrance Ramp Markings (Sheet 4 of 6)

D - Tapered acceleration lane - Raised Pavement Markers

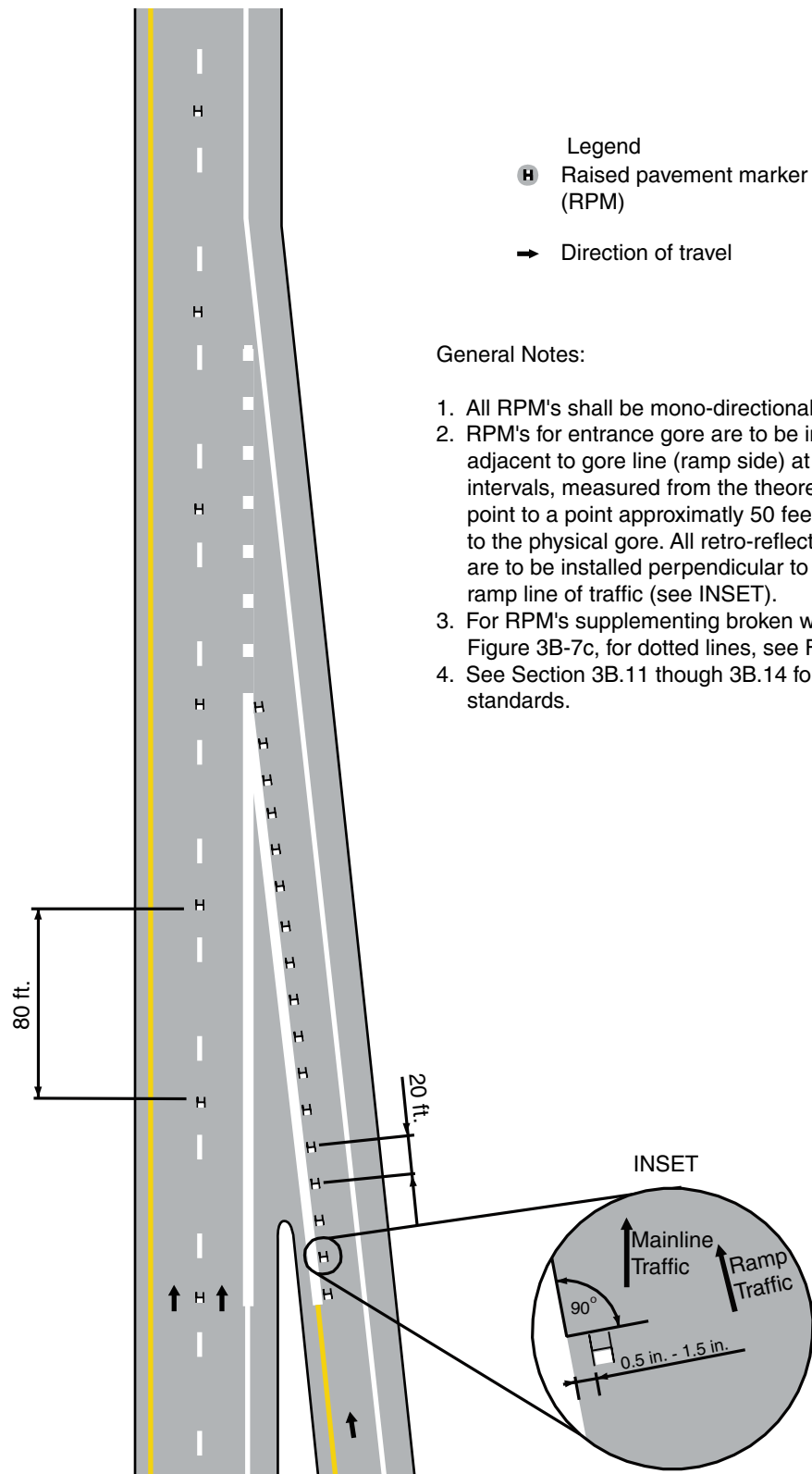

Figure 3B-9. Examples of Dotted Line and Channelizing Line Applications for Entrance Ramp Markings (Sheet 5 of 6)

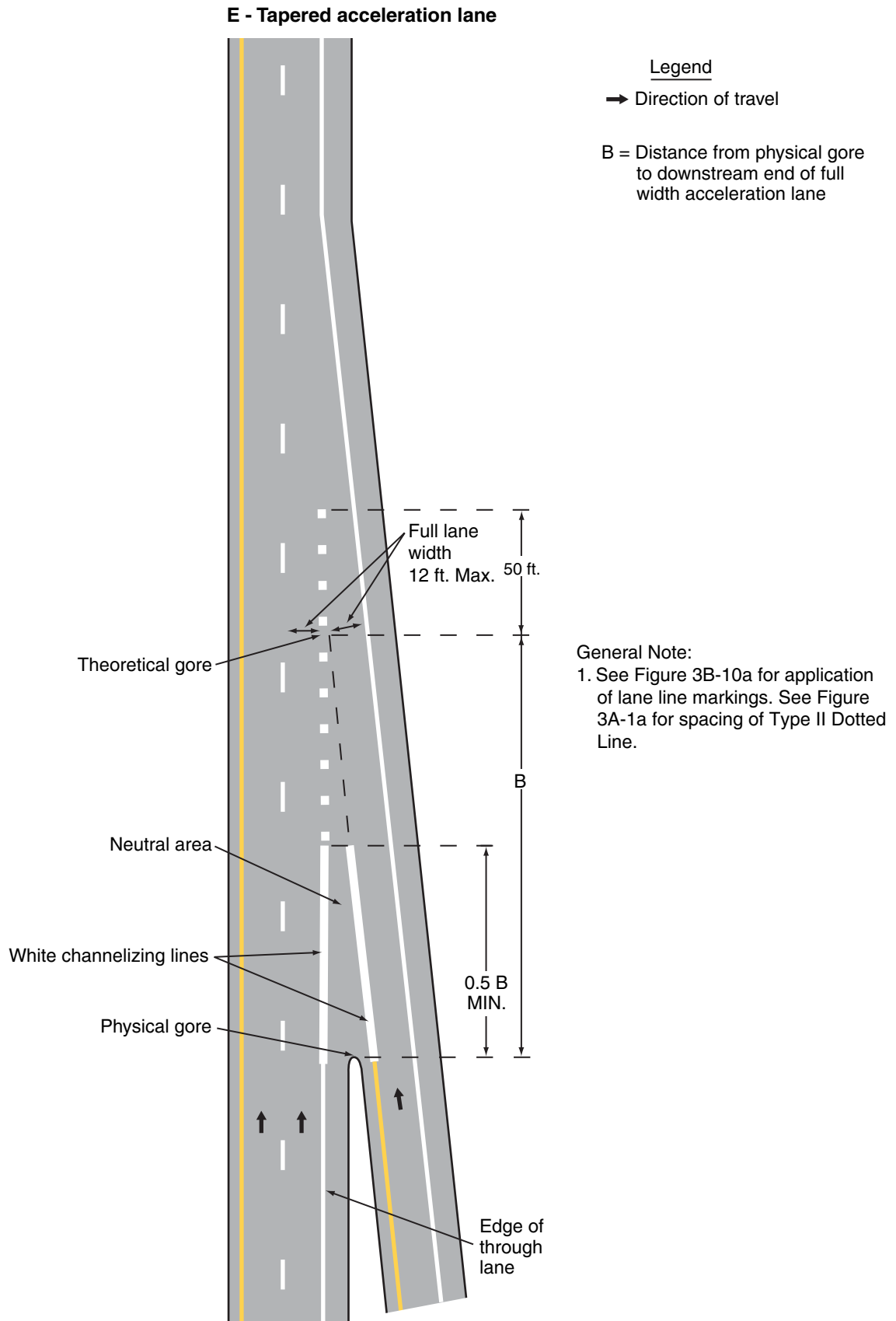

Figure 3B-9. Examples of Dotted Line and Channelizing Line Applications for Entrance Ramp Markings (Sheet 6 of 6)

F - Tapered acceleration lane - Raised Pavement Markers

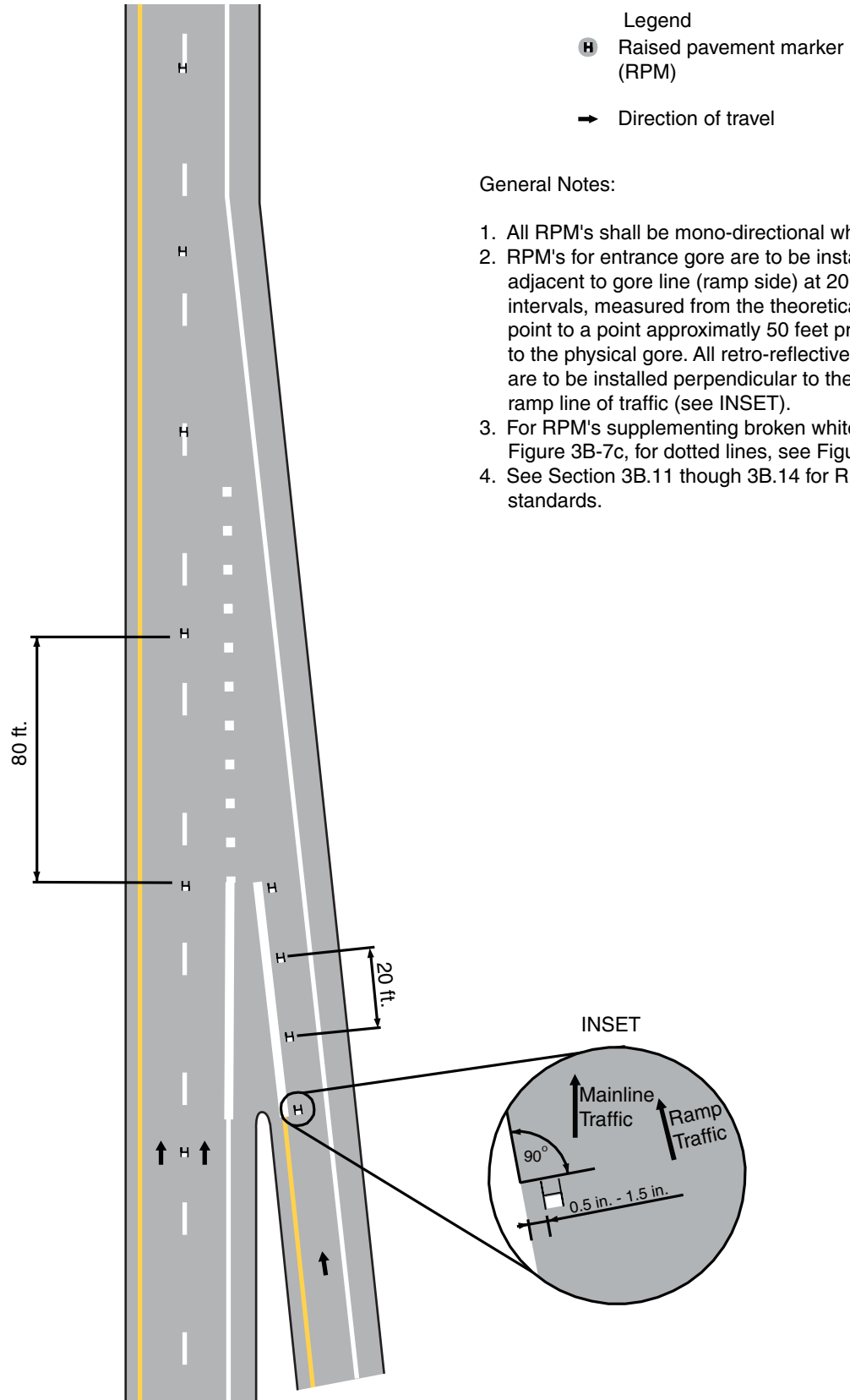

Figure 3B-9a. Examples of Interchange Ramps Marking - Free Access Lane.

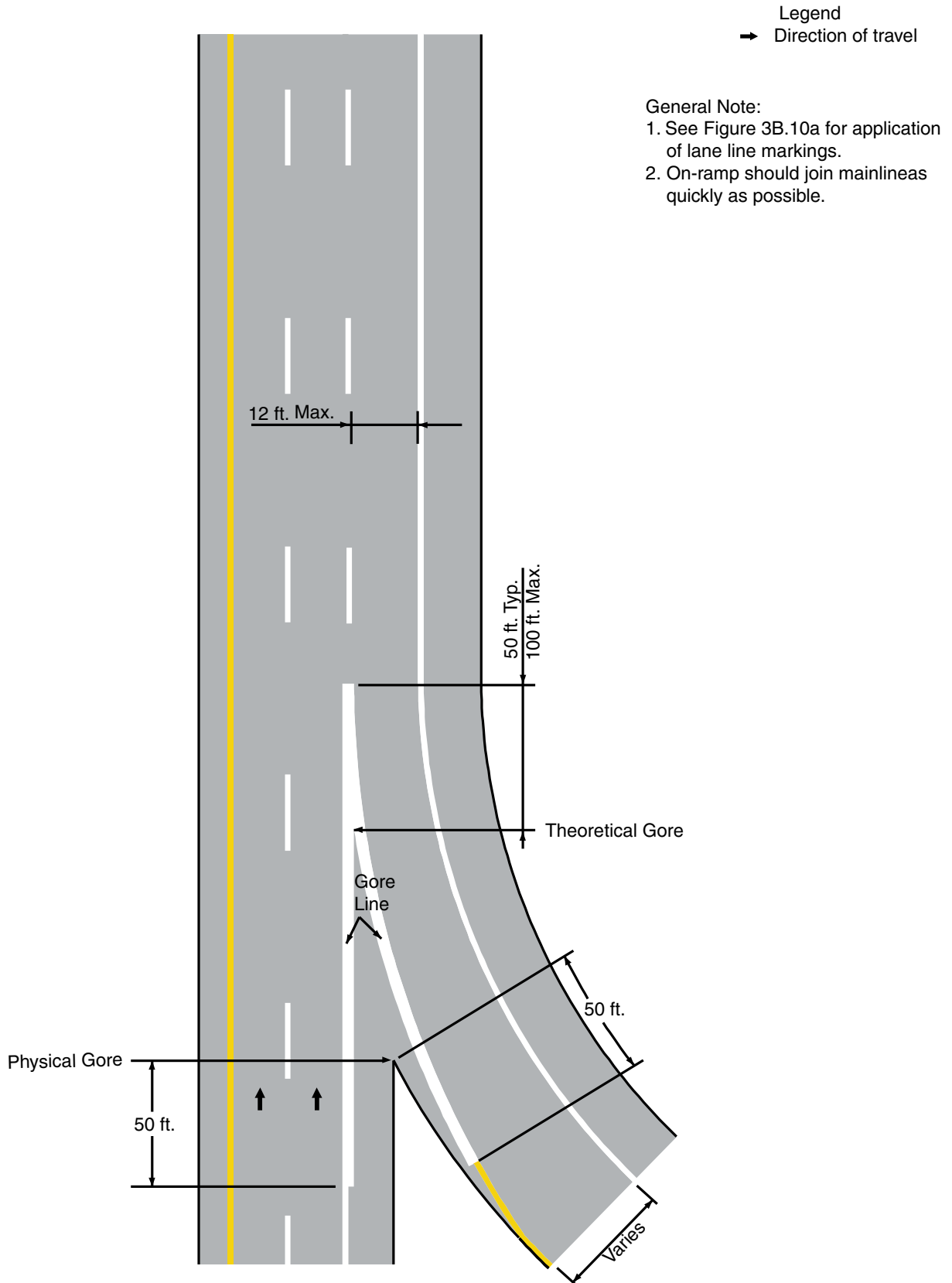
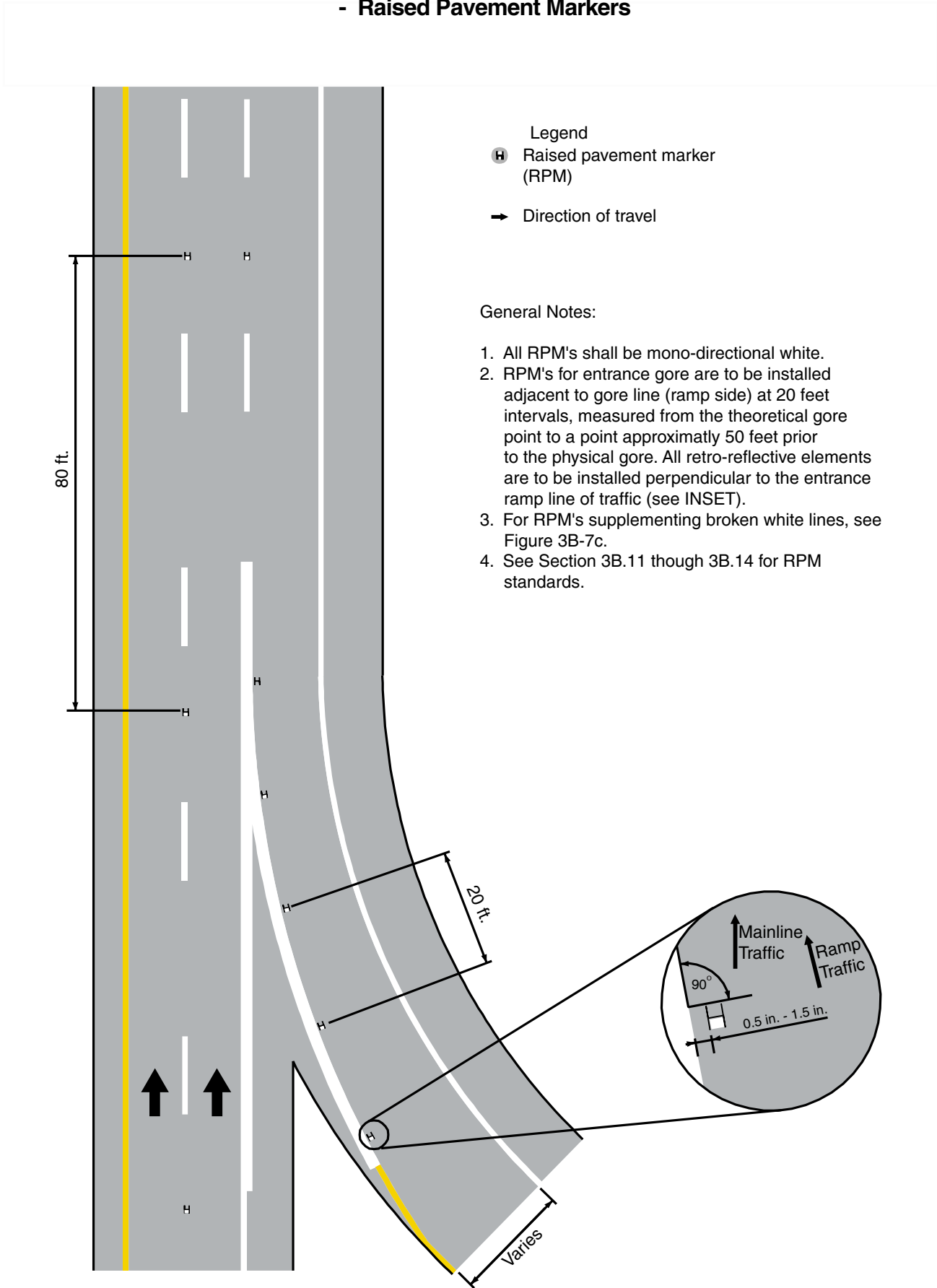

Figure 3B-9b. Examples of Interchange Ramps Marking - Free Access Lane - Raised Pavement Markers



- Legend
- ⊕ Raised pavement marker (RPM)
 - ➔ Direction of travel

General Notes:

1. All RPM's shall be mono-directional white.
2. RPM's for entrance gore are to be installed adjacent to gore line (ramp side) at 20 feet intervals, measured from the theoretical gore point to a point approximately 50 feet prior to the physical gore.
3. For RPM's supplementing broken white lines, see Figure 3B-7c.
4. See Section 3B.11 through 3B.14 for RPM standards.

**Figure 3B-9c. Examples of Channelizing Line
- Neutral Area Chevron Marking.**

a - Application for Exit Ramp

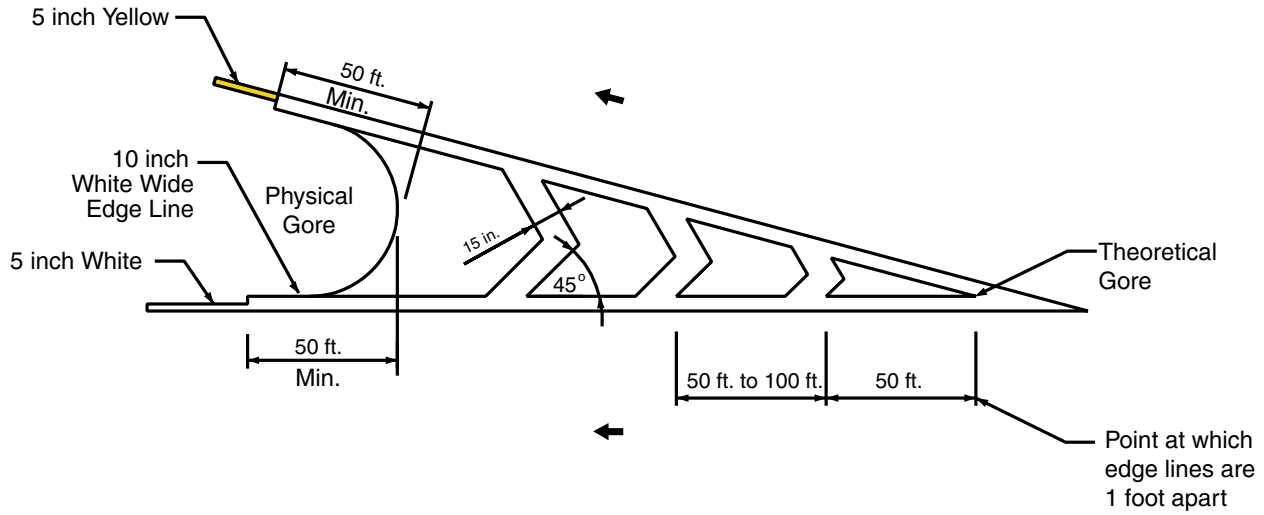

Notes:

Use of gore hatching applied to freeway gores is restricted for special emphasis only.

When applied, the following shall be used:

- Cross hatching are 15 inch wide with minimum space between hatches ranging from 50 feet for blunt angle gores, up to 100 feet for sharp angle gores.
- Recessed or raised pavement markers RPM's are to be set 0.5 inch to 1.5 inch outside lines and 2 inch from construction joint.

b - Application for Entrance Ramp

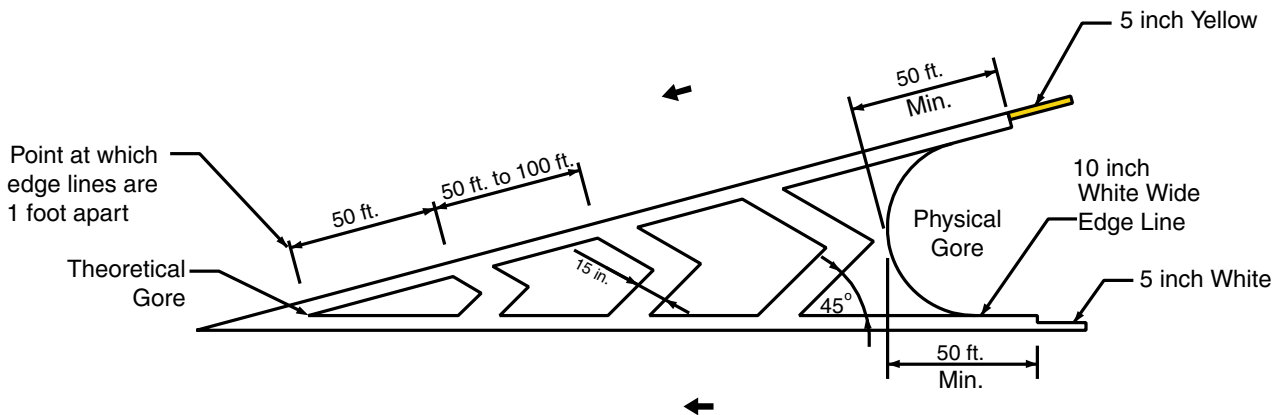

Guidance:

- 14 *Lane drop markings used in advance of lane drops at freeway and expressway exit ramps should begin at least 1/2 mile in advance of the theoretical gore.*
- 15 *On the approach to a multi-lane exit ramp having an optional exit lane that also carries through traffic, lane line markings should be used as illustrated in Drawing C of Figure 3B-10. In this case, if the right-most exit lane is an added lane such as a parallel deceleration lane, the lane drop marking should begin at the upstream end of the full-width deceleration lane, as shown in Drawing E of Figure 3B-8.*
- 16 *Lane drop markings used in advance of lane drops at intersections should begin a distance in advance of the intersection that is determined by engineering judgment as suitable to enable drivers who do not desire to make the mandatory turn to move out of the lane being dropped prior to reaching the queue of vehicles that are waiting to make the turn. The lane drop marking should begin no closer to the intersection than the most upstream regulatory or warning sign associated with the lane drop.*
- 17 *The dotted white lane lines that are used for lane drop markings and that are used as a lane line separating through lanes from auxiliary lanes should consist of line segments that are 3 feet in length separated by 9-foot gaps.*

Support:

- 18 Section 3B.20 contains information regarding other markings that are associated with lane drops, such as lane-use arrow markings and ONLY word markings.
- 19 Section 3B.09 contains information about the lane line markings that are to be used for transition areas where the number of through lanes is reduced.

Standard:

- 20 **Where crossing the lane line markings is discouraged, the lane line markings shall consist of a normal or wide solid white line.**

Option:

- 21 Where it is intended to discourage lane changing on the approach to an exit ramp, a wide solid white lane line may extend upstream from the theoretical gore or, for multi-lane exits, as shown in Drawing C of Figure 3B-10, for a distance that is determined by engineering judgment.
- 22 Where lane changes might cause conflicts, a wide or normal solid white lane line may extend upstream from an intersection.
- 23 In the case of a lane drop at an exit ramp or intersection, such a solid white line may replace a portion, but not all of the length of the wide dotted white lane line.

Support:

- 24 Section 3B.09 contains information about the lane line markings that are to be used for transition areas where the number of through lanes is reduced.

Guidance:

- 25 *On approaches to intersections, a solid white lane line marking should be used to separate a through lane from an added mandatory turn lane.*

Option:

- 26 On approaches to intersections, solid white lane line markings may be used to separate adjacent through lanes or adjacent mandatory turn lanes from each other.
- 27 Where the median width allows the left-turn lanes to be separated from the through lanes to give drivers on opposing approaches a less obstructed view of opposing through traffic, white pavement markings may be used to form channelizing islands as shown in Figure 2B-17.
- 28 Solid white lane line markings may be used to separate through traffic lanes from auxiliary lanes, such as an added uphill truck lane or a preferential lane (see Section 3D.02).
- 29 Wide solid lane line markings may be used for greater emphasis.

Guidance:

- 29a *The discernible width of a double line, consisting of two parallel lines, should be approximately 10 inches.*
- 29b *High-occupancy vehicle (HOV) lane lines should be 10 inches wide.*

Standard:

- 30 **Where crossing the lane line markings is prohibited, the lane line markings shall consist of a solid double white line (see Figure 3B-12).**

Figure 3B-10. Examples of Applications of Freeway and Expressway Lane-Drop Markings (Sheet 1 of 10)

A – Lane drop at a single lane exit ramp

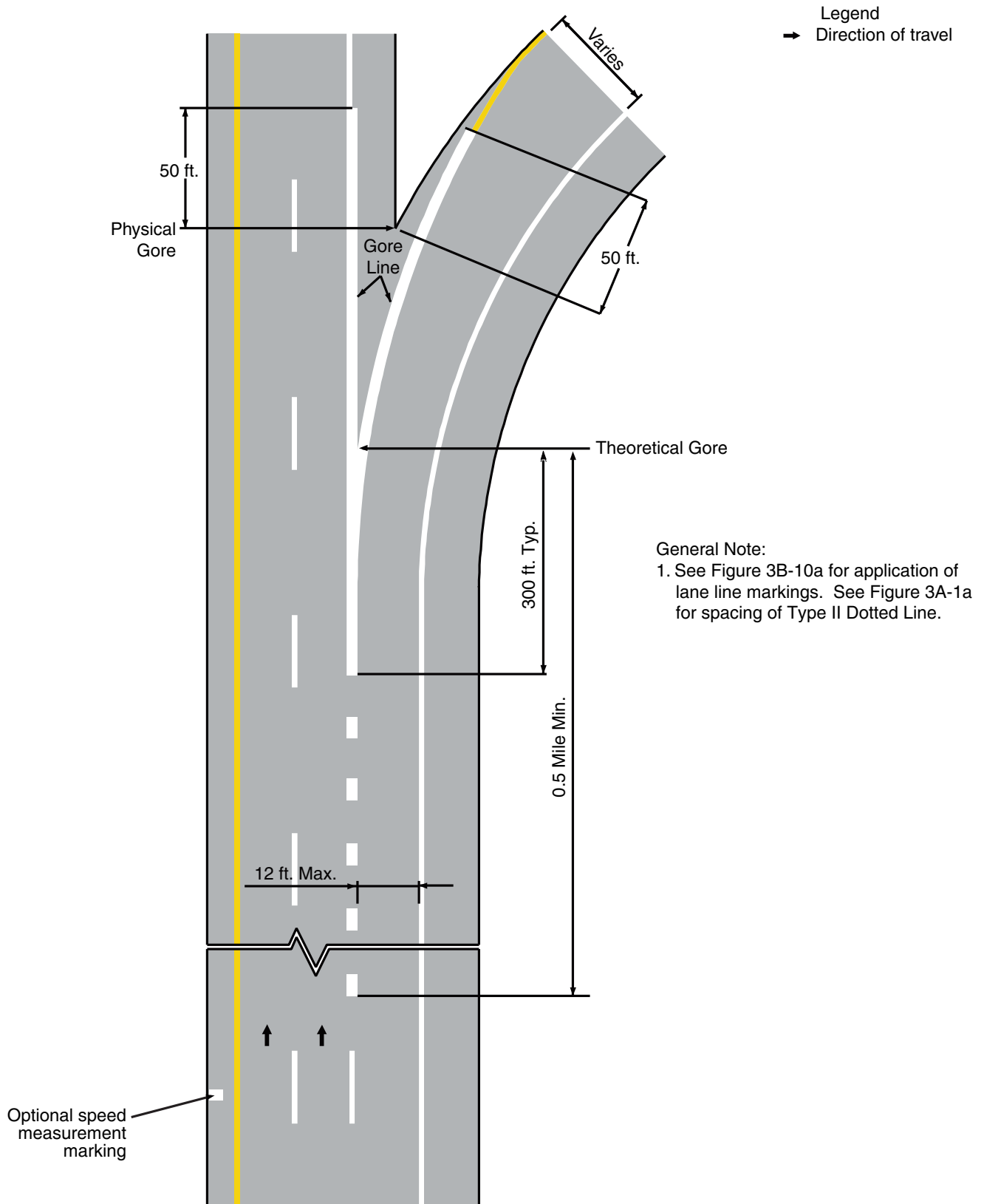

Figure 3B-10. Examples of Applications of Freeway and Expressway Lane-Drop Markings (Sheet 2 of 10)

B – Lane drop at a single lane exit ramp with raised pavement markers

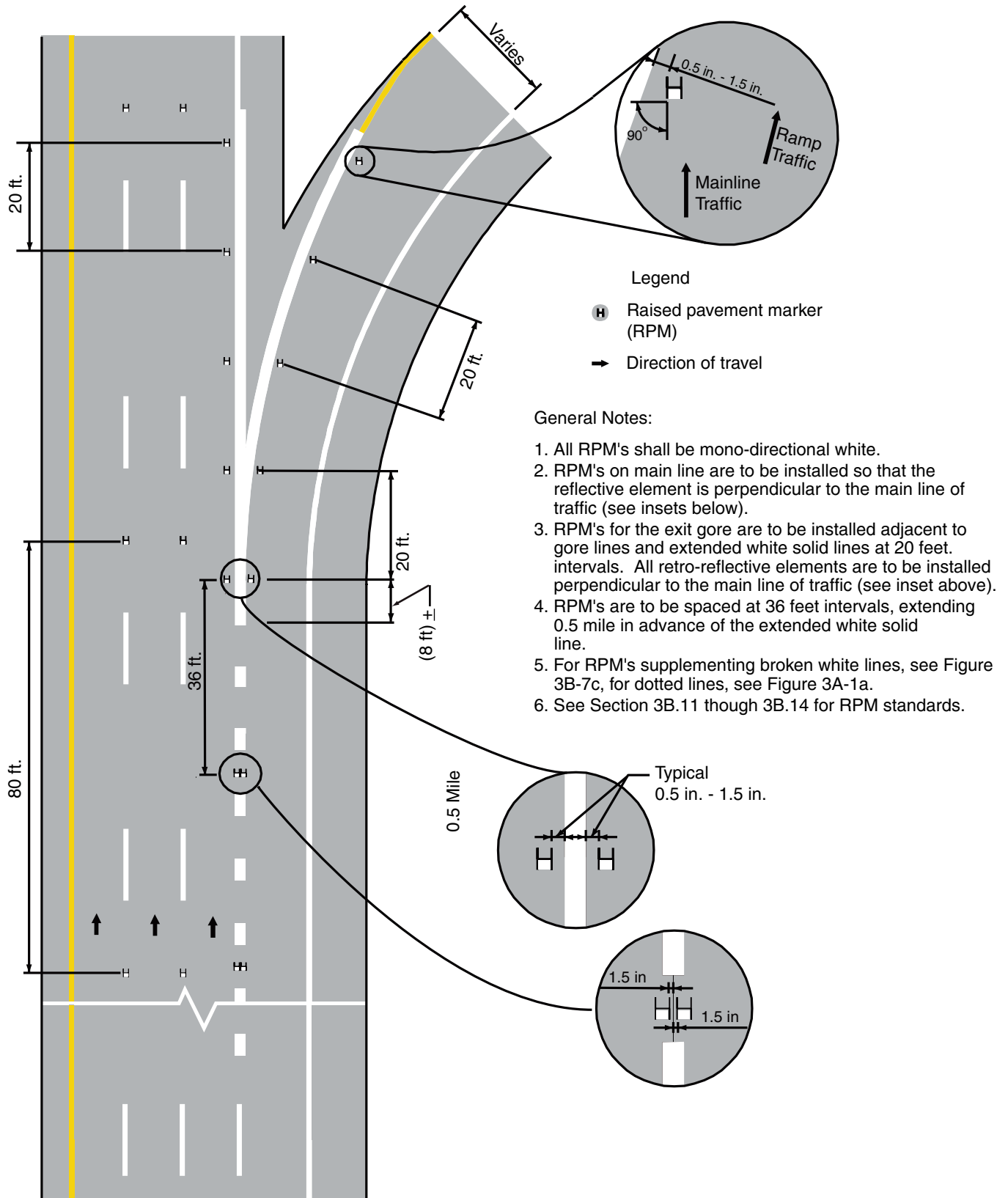

Figure 3B-10. Examples of Applications of Freeway and Expressway Lane-Drop Markings (Sheet 3 of 10)

C – Lane drop at a multi-lane exit ramp having an optional exit lane that also carries the through route

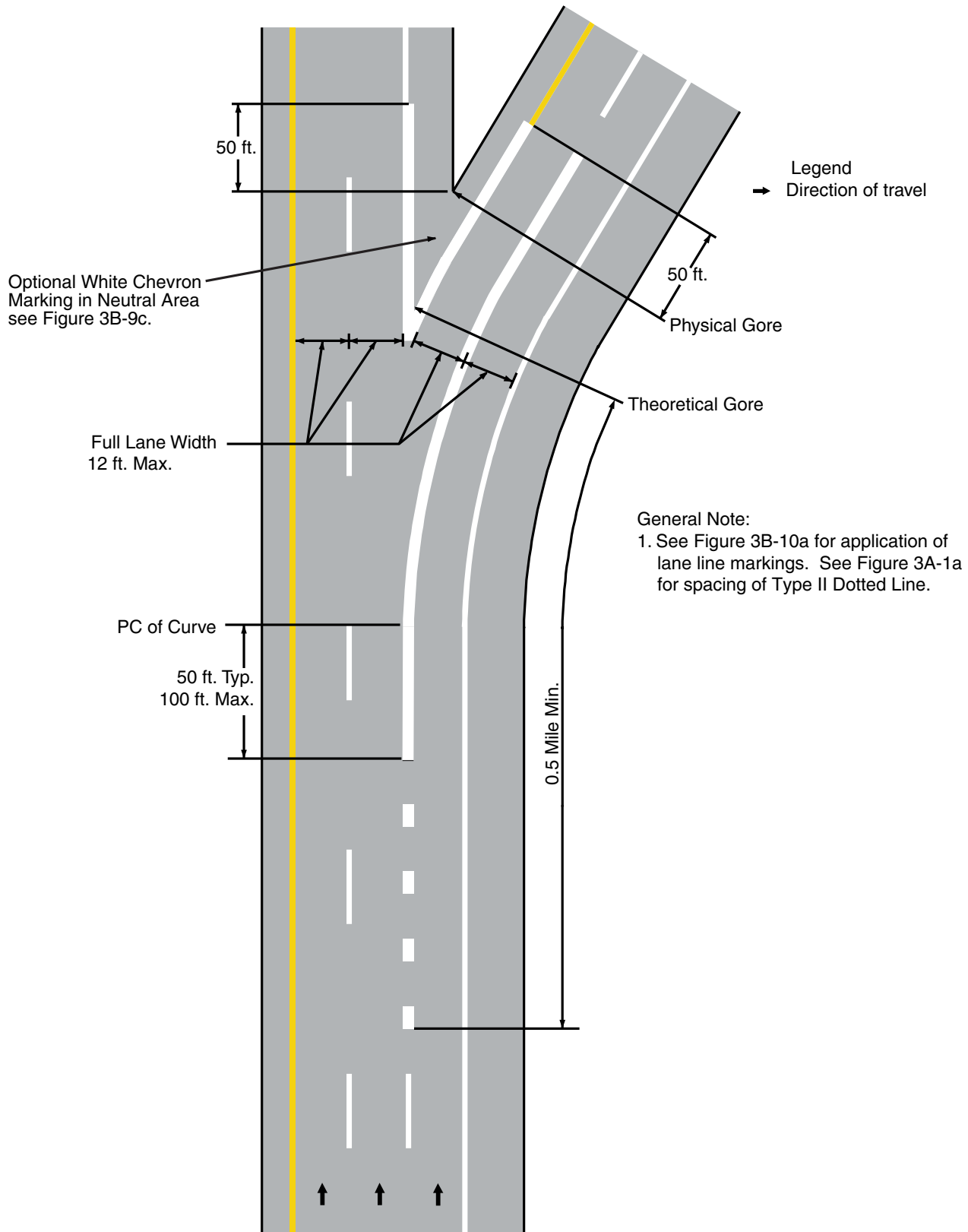

Figure 3B-10. Examples of Applications of Freeway and Expressway Lane-Drop Markings (Sheet 4 of 10)

D – Lane drop at a multi-lane exit ramp having an optional exit lane that also carries the through route with raised pavement markers

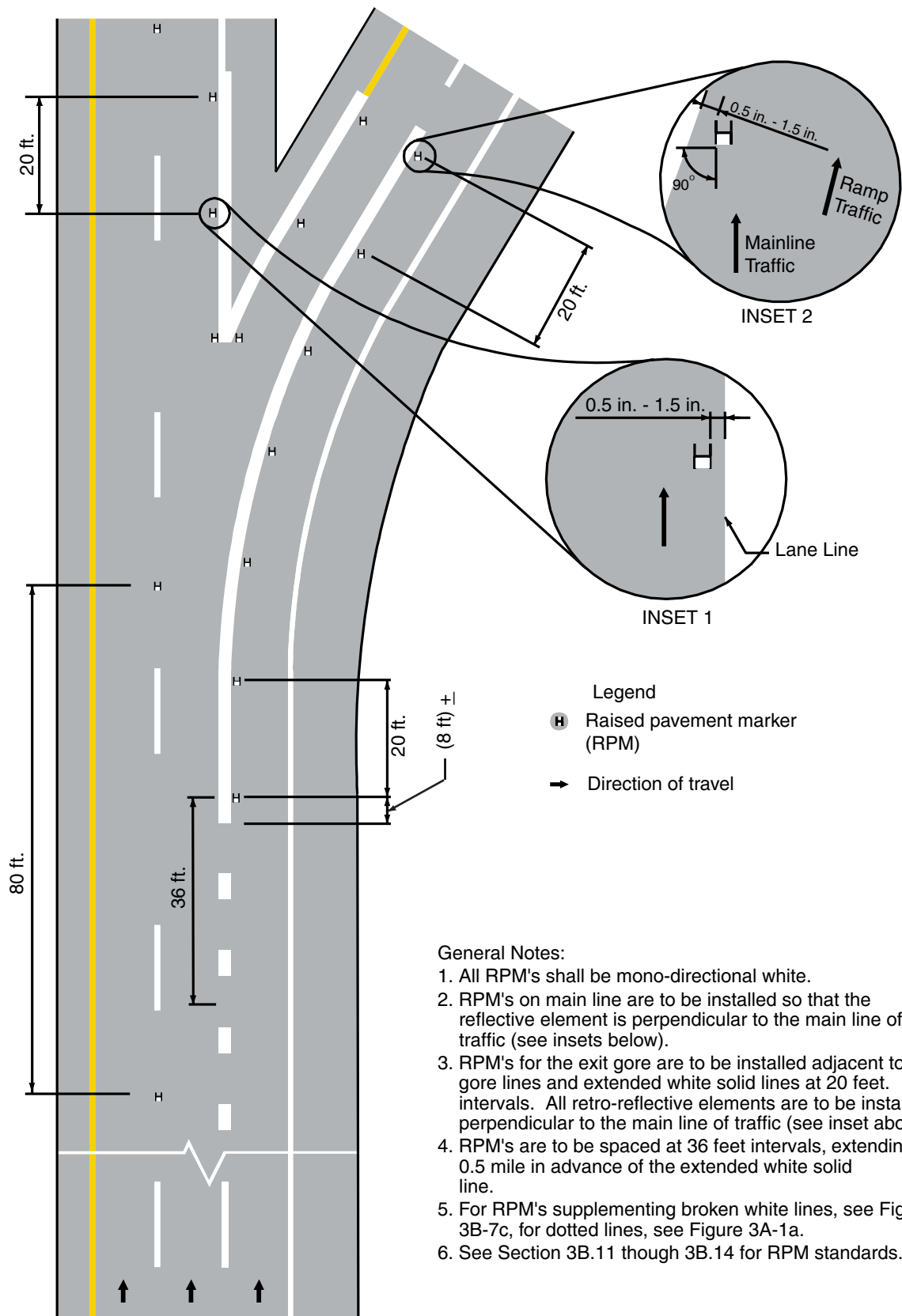

Figure 3B-10. Examples of Applications of Freeway and Expressway Lane-Drop Markings (Sheet 5 of 10)

E – Two-lane lane drop at an exit ramp

Legend

→ Direction of travel

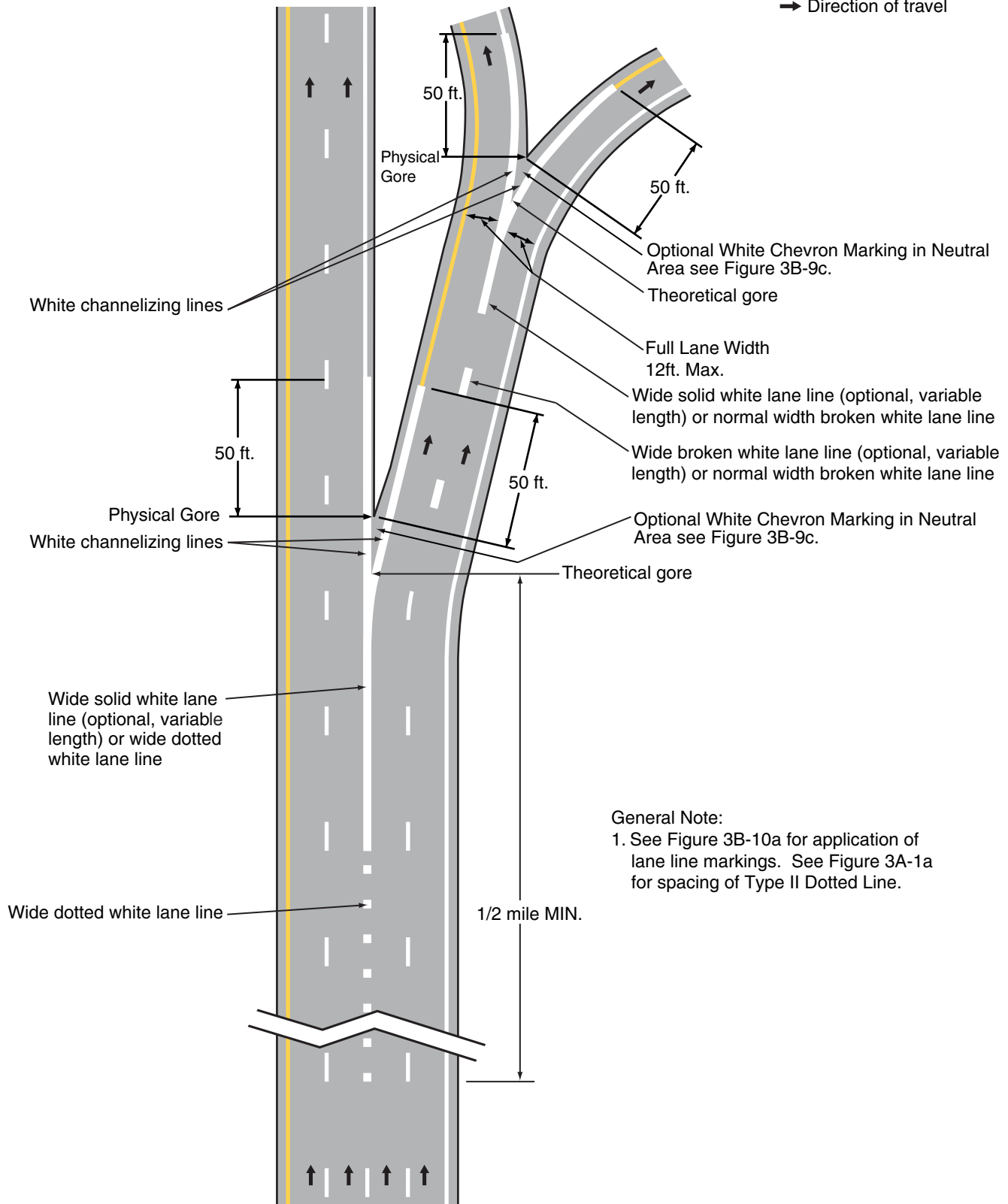

Figure 3B-10. Examples of Applications of Freeway and Expressway Lane-Drop Markings (Sheet 6 of 10)

F – Two-lane lane drop at an exit ramp with Raised Pavement Markers.

General Notes:

1. All RPM's shall be mono-directional white.
2. RPM's on main line are to be installed so that the reflective element is perpendicular to the main line of traffic (see insets below).
3. RPM's for the exit gore are to be installed adjacent to gore lines and extended white solid lines at 20 feet intervals. All retro-reflective elements are to be installed perpendicular to the main line of traffic (see inset above).
4. RPM's are to be spaced at 36 feet intervals, extending 0.5 mile in advance of the extended white solid line.
5. For RPM's supplementing broken white lines, see Figure 3B-7c, for dotted lines, see Figure 3A-1a.
6. See Section 3B.11 through 3B.14 for RPM standards.

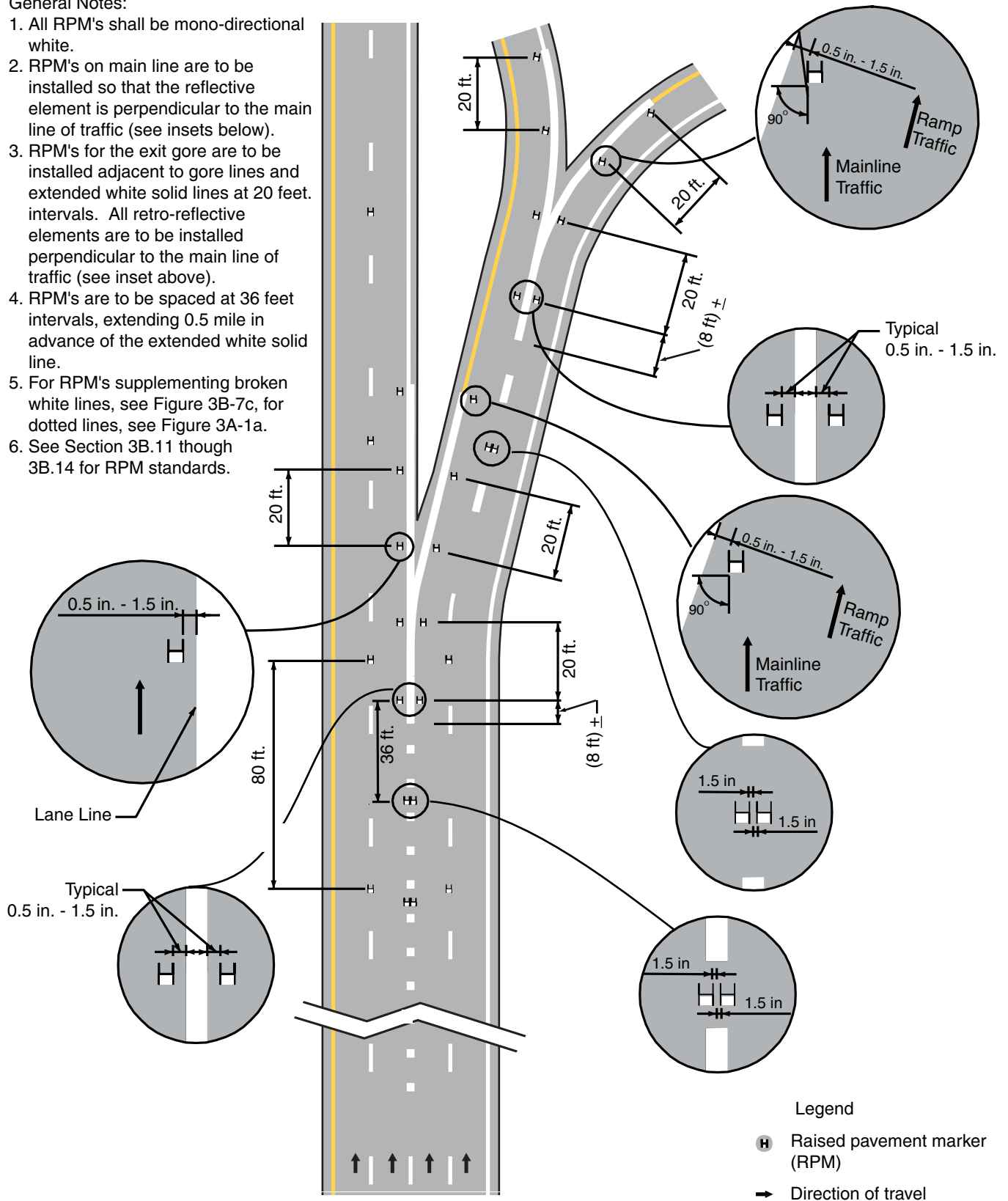

Figure 3B-10. Examples of Applications of Freeway and Expressway Lane-Drop Markings (Sheet 7 of 10)

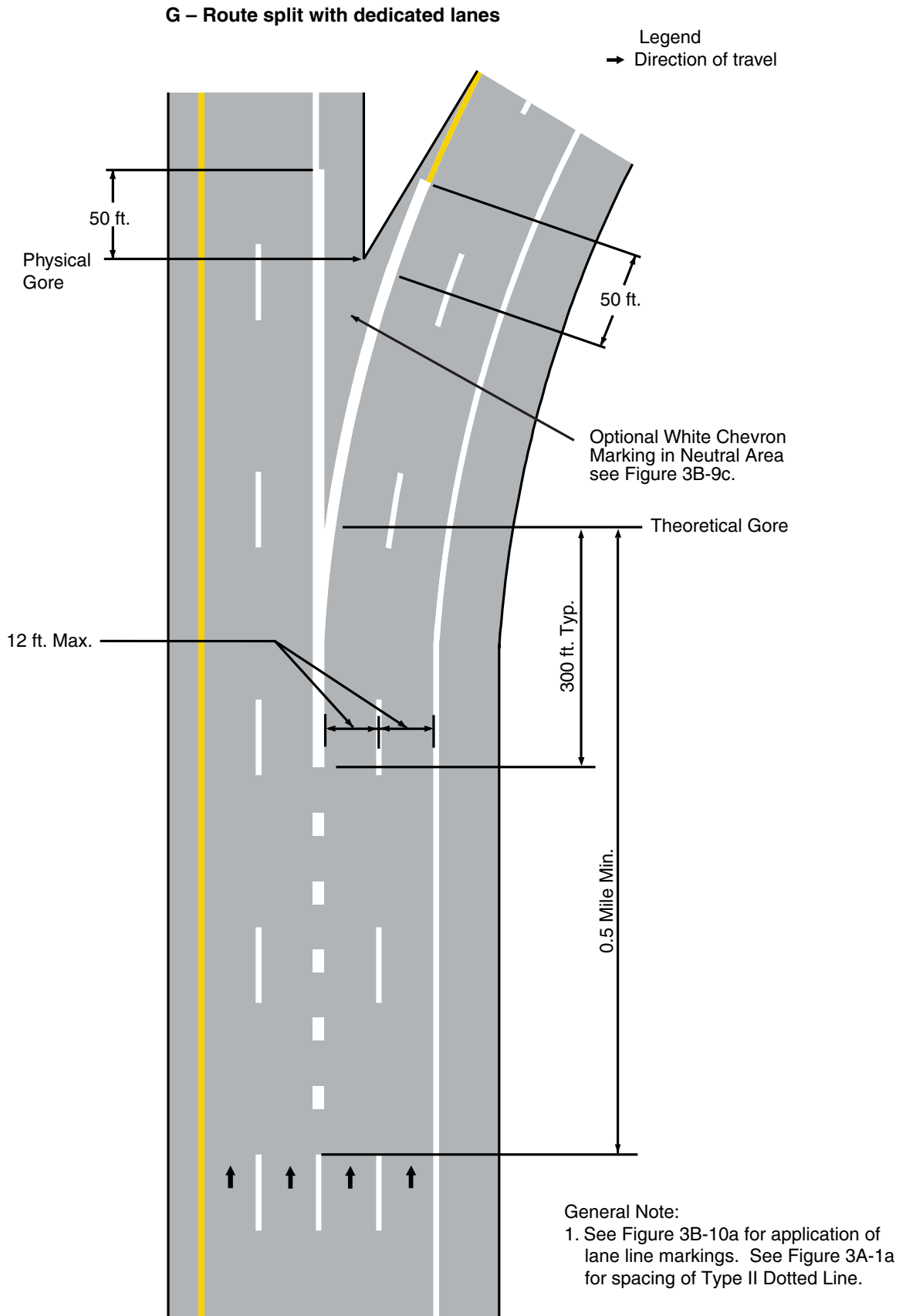

Figure 3B-10. Examples of Applications of Freeway and Expressway Lane-Drop Markings (Sheet 8 of 10)

H – Route split with dedicated lanes with raised pavement markers

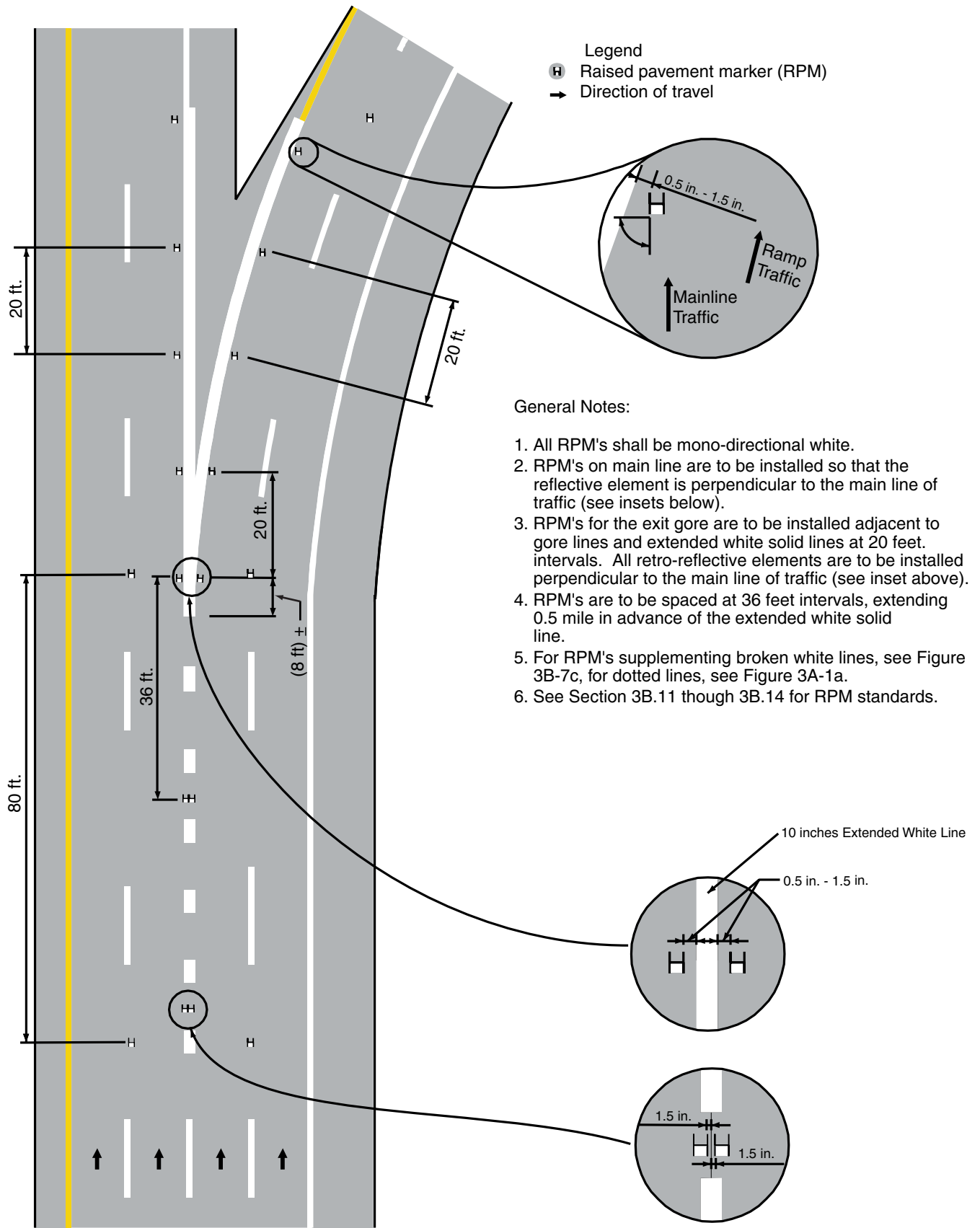

Figure 3B-10. Examples of Applications of Freeway and Expressway Lane-Drop Markings (Sheet 9 of 10)

I – Auxiliary lane, such as at a cloverleaf interchange

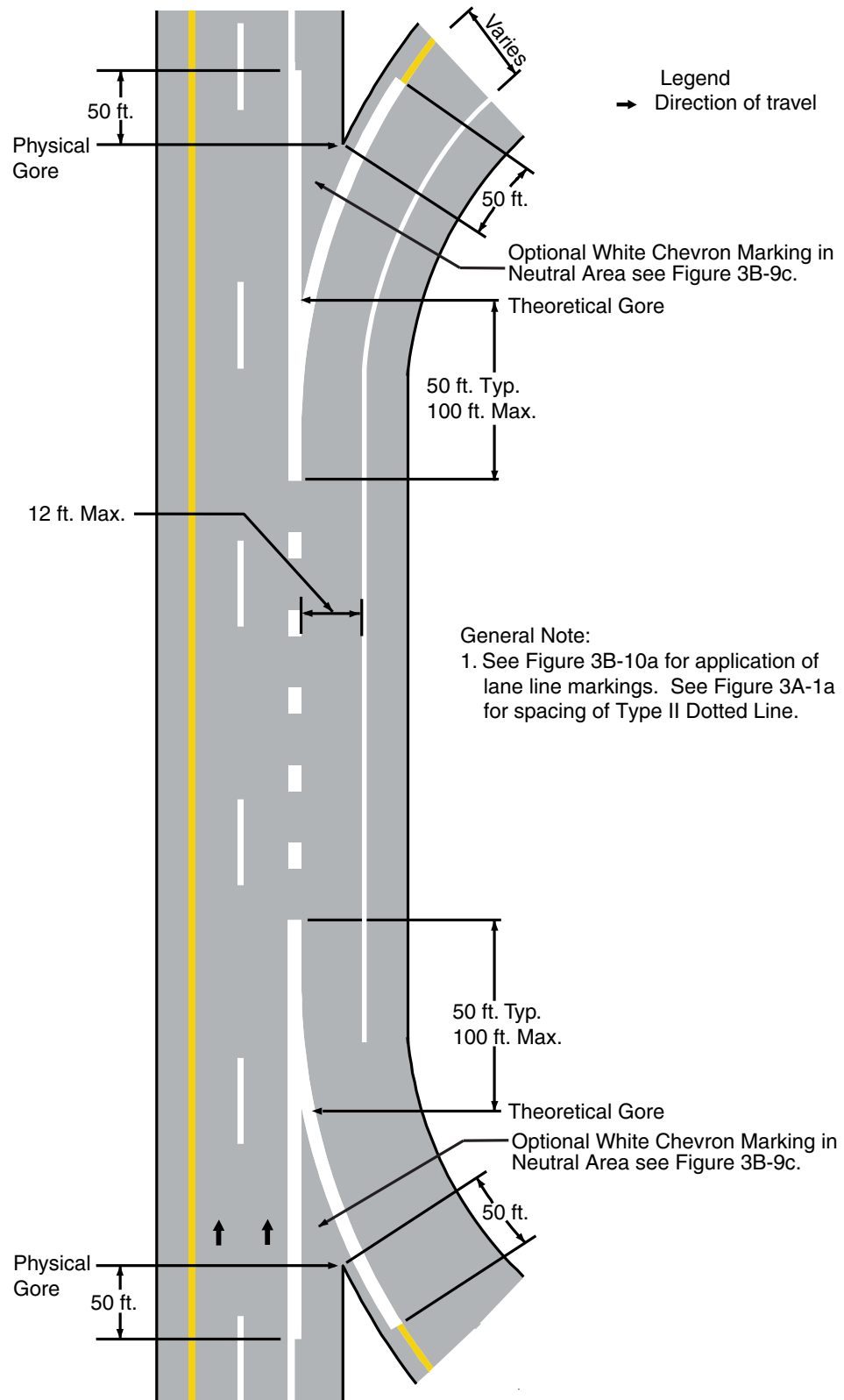

Figure 3B-10. Examples of Applications of Freeway and Expressway Lane-Drop Markings (Sheet 10 of 10)

J – Auxiliary lane, such as at a cloverleaf interchange raised pavement markers

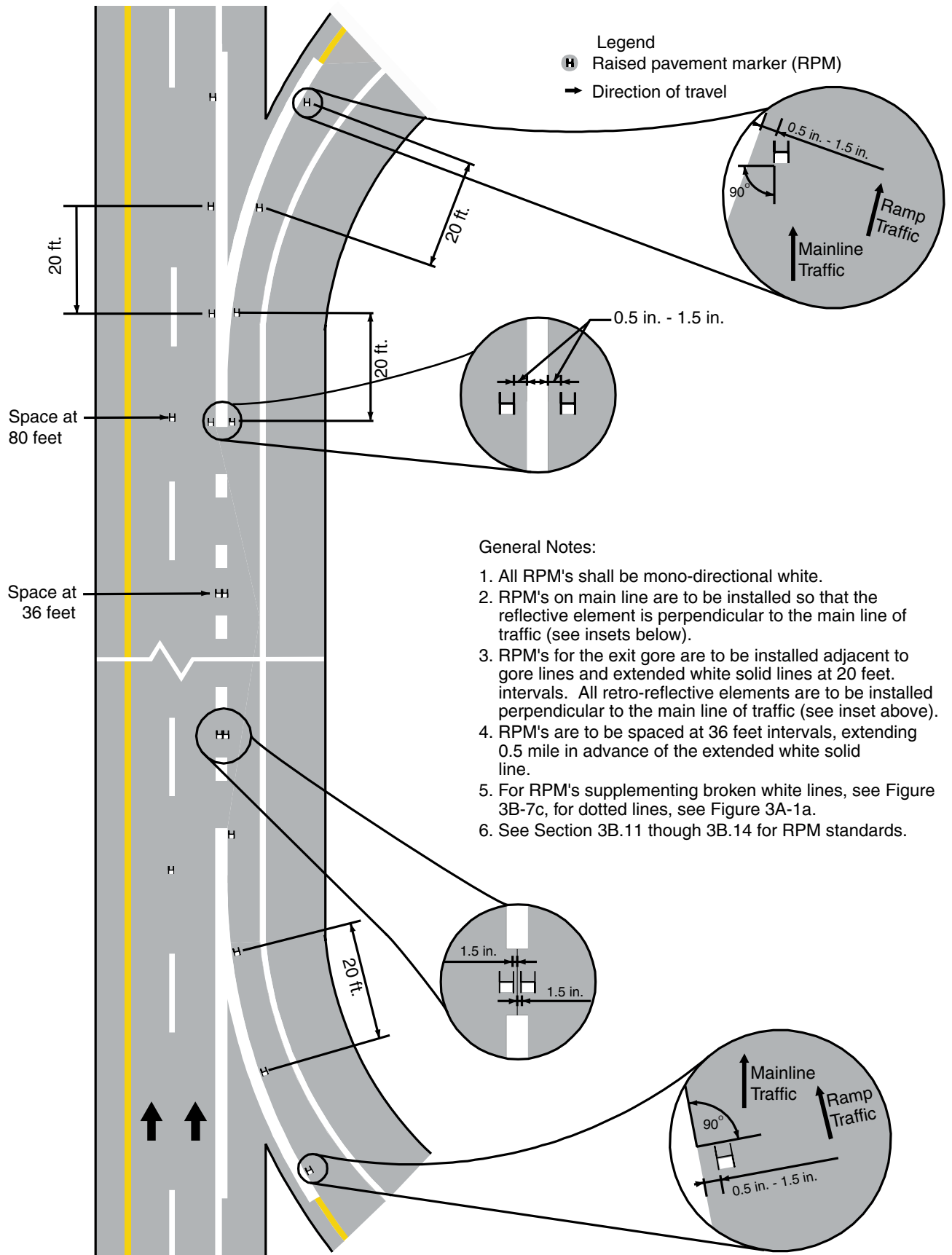
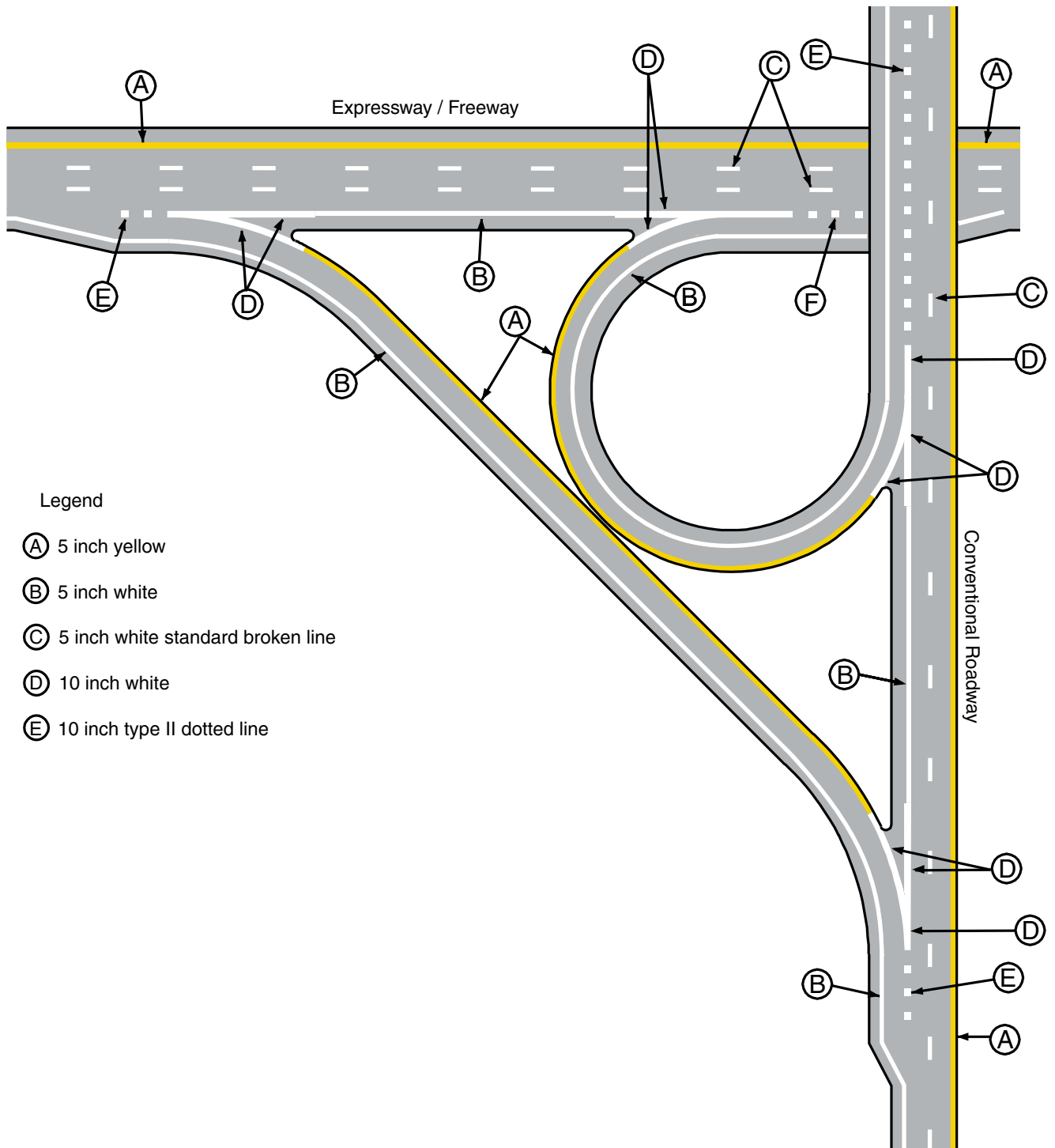

Figure 3B-10a. Examples of Expressway-Freeway and Conventional Roadway Lane Line Markings.



Legend

- (A) 5 inch yellow
- (B) 5 inch white
- (C) 5 inch white standard broken line
- (D) 10 inch white
- (E) 10 inch type II dotted line

Figure 3B-11. Examples of Applications of Conventional Road Lane-Drop Markings
(Sheet 1 of 2)

A – Lane drop at an intersection

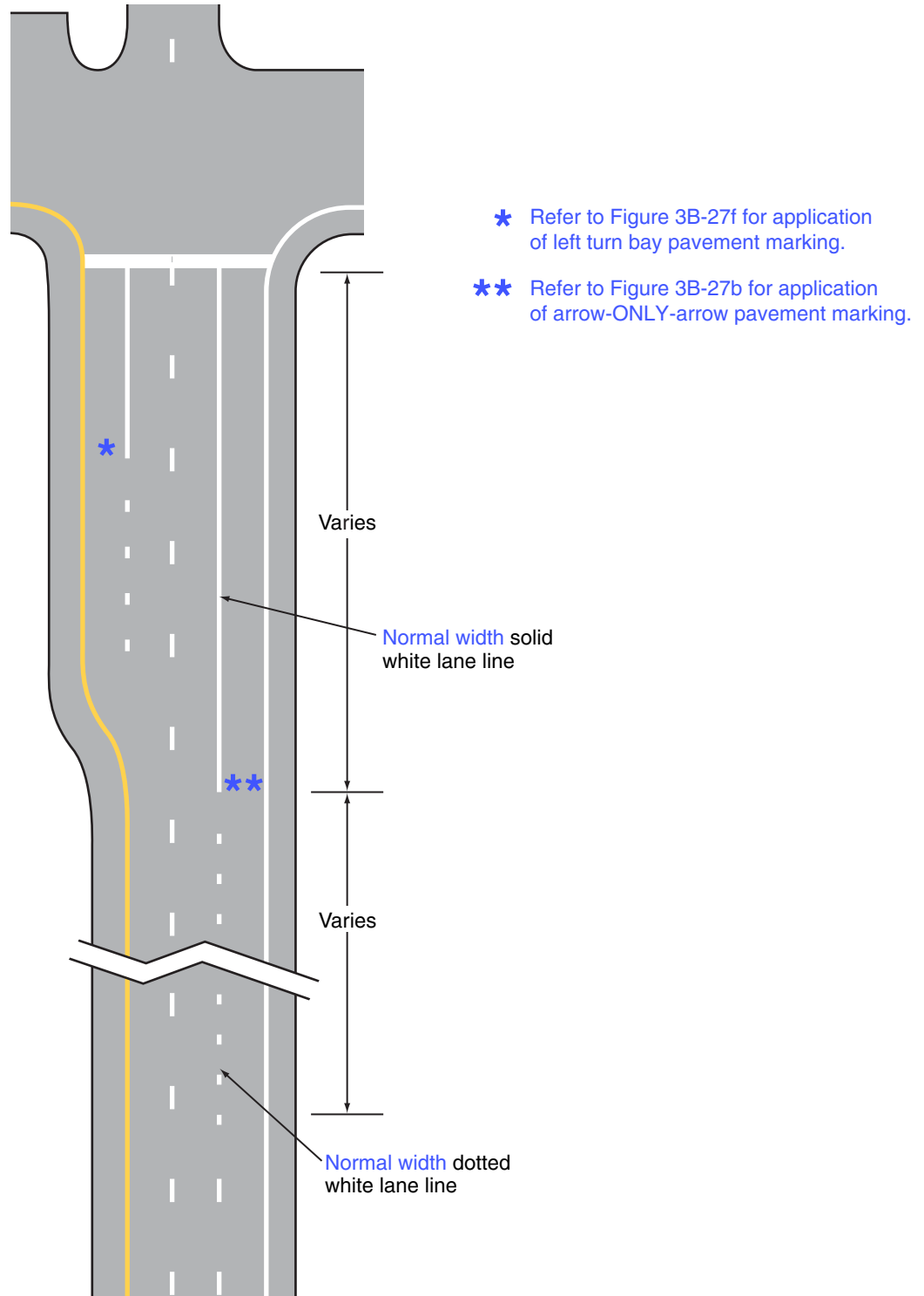
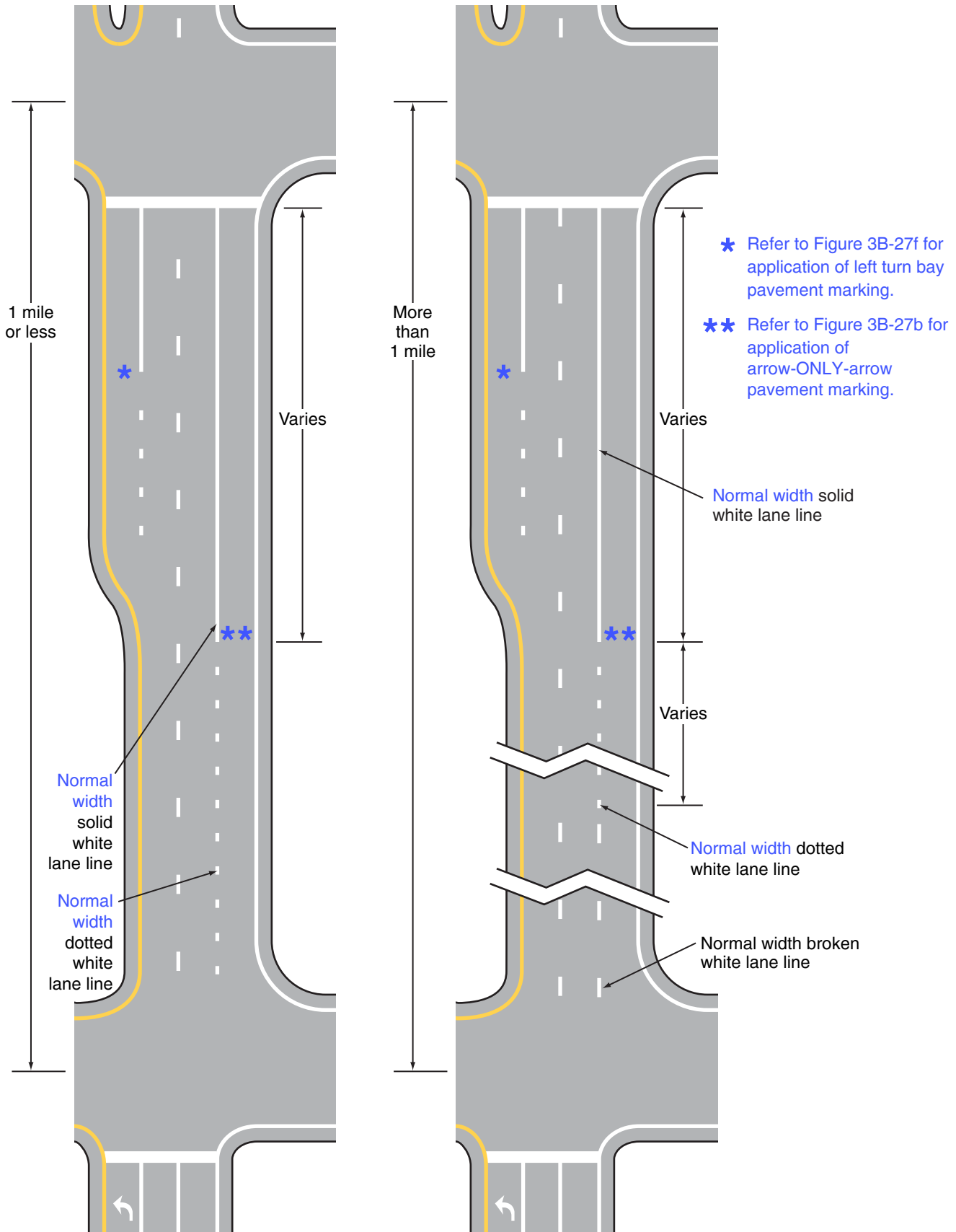

Figure 3B-11. Examples of Applications of Conventional Road Lane-Drop Markings
(Sheet 2 of 2)

B – Auxiliary lane between intersections



Section 3B.05 Other White Longitudinal Pavement Markings

Standard:

01 **A channelizing line shall be a wide or double solid white line.**

Option:

02 Channelizing lines may be used to form channelizing islands where traffic traveling in the same direction is permitted on both sides of the island.

Standard:

03 **Other pavement markings in the channelizing island area shall be white.**

Support:

04 Examples of channelizing line applications are shown in Figures 3B-8, 3B-9, and 3B-10, and in Drawing C of Figure 3B-15.

05 Channelizing lines at exit ramps as shown in Figures 3B-8 and 3B-10 define the neutral area, direct exiting traffic at the proper angle for smooth divergence from the main lanes into the ramp, and reduce the probability of colliding with objects adjacent to the roadway.

06 Channelizing lines at entrance ramps as shown in Figures 3B-9 and 3B-10 promote orderly and efficient merging with the through traffic.

Standard:

07 **For all exit ramps and for entrance ramps with parallel acceleration lanes, channelizing lines shall be placed on both sides of the neutral area (see Figures 3B-8 and 3B-10 and Drawing A of Figure 3B-9).**

08 **For entrance ramps with tapered acceleration lanes, channelizing lines shall be placed along both sides of the neutral area to a point at least one-half of the distance to the theoretical gore (see Drawing E of Figure 3B-9).**

Option:

09 For entrance ramps with tapered acceleration lanes, the channelizing lines may extend to the theoretical gore as shown in Drawing B of Figure 3B-9.

10 White chevron crosshatch markings (see Section 3B.24) may be placed in the neutral area of exit ramp and entrance ramp gores for special emphasis as shown in Figures 3B-8 and 3B-10 and Drawing A of Figure 3B-9. The channelizing lines and the optional chevron crosshatch markings at exit ramp and entrance ramp gores may be supplemented with white retroreflective or internally illuminated raised pavement markers (see Sections 3B.11 and 3B.13) for enhanced nighttime visibility.

Figure 3B-12. Example of Solid Double White Lines Used to Prohibit Lane Changing

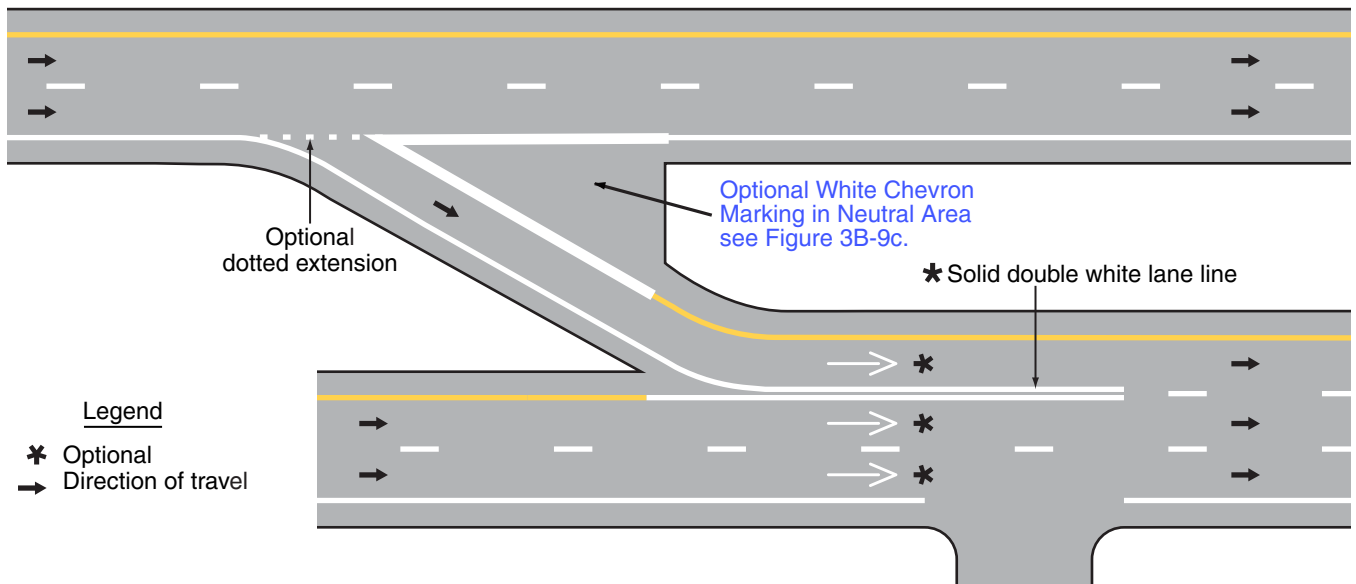

Section 3B.06 Edge Line Pavement Markings

Standard:

- 01 **If used, edge line pavement markings shall delineate the right or left edges of a roadway.**
- 02 **Except for **Type III** dotted edge line extensions (see Section 3B.08), edge line markings shall not be continued through intersections or major driveways.**
- 03 **If used on the roadways of divided highways or one-way streets, or on any ramp in the direction of travel, left edge line pavement markings shall consist of a normal **5-inch** solid yellow line to delineate the left-hand edge of a roadway or to indicate driving or passing restrictions left of these markings.**
- 04 **If used, right edge line pavement markings shall consist of a normal **5-inch** solid white line to delineate the right-hand edge of the roadway.**

Guidance:

- 05 *Edge line markings should not be broken for minor driveways.*
- 05a *Right lanes should be wider on a multi-lane roadway. The width of edge lines should be 5-inch for conventional roadways, expressways and freeways.*

Support:

- 06 Edge line markings have unique value as visual references to guide road users during adverse weather and visibility conditions.
- 06a Examples of interchange ramps pavement marking are shown in Figures 3B-8, Figures 3B-9, Figures 3B-9a and 3B-9b, Figures 3B-10, and Figure 3B-10a.

Standard:

- 06b **If used, wide edge lines shall be 10-inches wide and shall conform to Figure 3B-12a.**

Option:

- 06c Wide edge lines may be used where accident patterns or potential safety problems suggest likely benefits.

Standard:

- 06d **Edge lines shall be placed on both sides of all freeway and expressway ramps, whether curbed or not. In all cases where edge lines are placed on the left side of ramps, they shall be yellow between the end limits of the wide white gore channelizing markings (see Section 3B.05).**

Guidance:

- 06e *Where ramp edge lines are placed along closed or curbed sections, the edge line should be placed a minimum of 12-inches off the face of the curb as so not to be obliterated by dirt or debris in the gutter channel. When edge lines are placed along open or non-curbed sections, the edge line should be placed a minimum of 4-inches inside the edge of the paving.*

Section 3B.07 Warrants for Use of Edge Lines

Standard:

- 01 **Edge line markings shall be placed on paved streets or highways with the following characteristics:**
- A. Freeways,**
 - B. Expressways, and**
 - C. Rural arterials with a traveled way of 20 feet or more in width and an ADT of 6,000 vehicles per day or greater.**

Guidance:

- 02 *Edge line markings should be placed on paved streets or highways with the following characteristics:*
- A. Rural arterials and collectors with a traveled way of 20 feet or more in width and an ADT of 3,000 vehicles per day or greater.*
 - B. On other paved streets and highways where an engineering study indicates a need for edge line markings.*
- 03 *Edge line markings should not be placed where an engineering study or engineering judgment indicates that providing them is likely to decrease safety.*

Figure 3B-12a. Examples of Expressway-Freeway and Conventional Roadway Lane Line Markings.

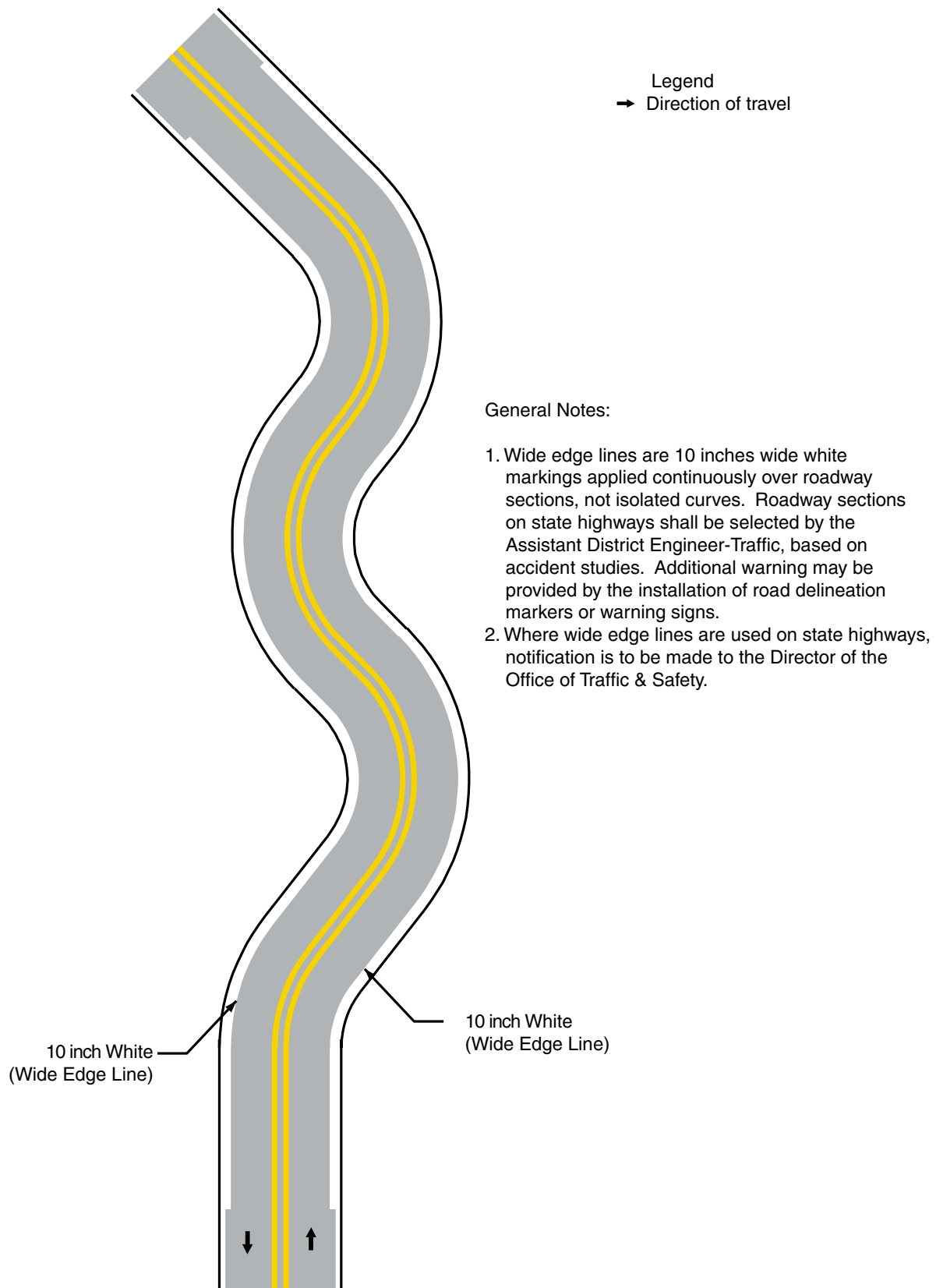

Option:

- 04 Edge line markings may be placed on streets and highways with or without center line markings.
- 05 Edge line markings may be excluded, based on engineering judgment, for reasons such as if the traveled way edges are delineated by curbs, parking, or other markings.
- 06 If a bicycle lane is marked on the outside portion of the traveled way, the edge line that would mark the outside edge of the bicycle lane may be omitted.
- 07 Edge line markings may be used where edge delineation is desirable to minimize unnecessary driving on paved shoulders or on refuge areas that have lesser structural pavement strength than the adjacent roadway.

Section 3B.08 Extensions Through Intersections or Interchanges

Support:

- 00 The “Guideline for Using Edge Line Extensions and Yield Lines” contains further information regarding markings for edge line extensions and yield lines. This document can be obtained from the Maryland State Highway Administration’s Office of Traffic & Safety, Traffic Development & Support Division (TDSD) at the address shown on Page i.

Standard:

- 01 **Except as provided in Paragraph 2, pavement markings extended into or continued through an intersection or interchange area shall be the same color and at least the same width as the line markings they extend (see Figure 3B-13).**

Option:

- 02 A normal line may be used to extend a wide line through an intersection.

Guidance:

- 03 *Where highway design or reduced visibility conditions make it desirable to provide control or to guide vehicles through an intersection or interchange, such as at offset, skewed, complex, or multi-legged intersections, on curved roadways, where multiple turn lanes are used, or where offset left turn lanes might cause driver confusion, dotted line extension markings consisting of 2-foot line segments and 2- to 6-foot gaps should be used to extend longitudinal line markings through an intersection or interchange area.*

Standard:

- 03a **Dotted line extension markings through intersections shall be Type III (see Figure 3A-1a).**

Option:

- 04 Dotted edge line extensions may be placed through intersections or major driveways.

Guidance:

- 05 *Where greater restriction is required, solid lane lines or channelizing lines should be extended into or continued through intersections or major driveways.*

Standard:

- 06 **Solid lines shall not be used to extend edge lines into or through intersections or major driveways.**

Guidance:

- 07 *Where a double line is extended through an intersection, a single line of equal width to one of the lines of the double line should be used.*
- 08 *To the extent possible, pavement marking extensions through intersections should be designed in a manner that minimizes potential confusion for drivers in adjacent or opposing lanes.*

Section 3B.09 Lane-Reduction Transition Markings

Support:

- 01 Lane-reduction transition markings are used where the number of through lanes is reduced because of narrowing of the roadway or because of a section of on-street parking in what would otherwise be a through lane. Lane-reduction transition markings are not used for lane drops.

Standard:

- 02 **Except as provided in Paragraph 3, where pavement markings are used, lane-reduction transition markings shall be used to guide traffic through transition areas where the number of through lanes is reduced, as shown in Figures 3B-14, 3B-14a, and 3B-14b. On two-way roadways, no-passing zone markings shall be used to prohibit passing in the direction of the convergence, and shall continue through the transition area.**

Figure 3B-13. Examples of Line Extensions through Intersections (Sheet 1 of 4)

A - Typical pavement markings with offset lane lines continued through the intersection and optional crosswalk lines and stop lines

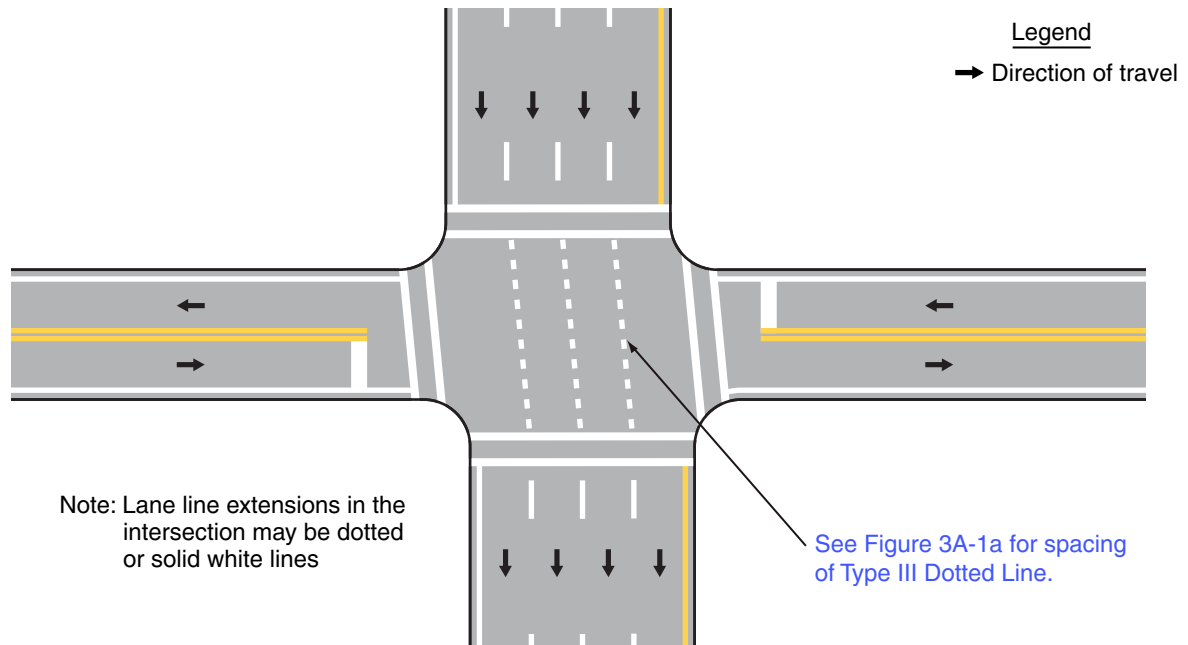

B - Typical pavement markings with double-turn lanes, lane-use turn arrows, and optional crosswalk lines, stop lines, and line extensions into intersection for double turns

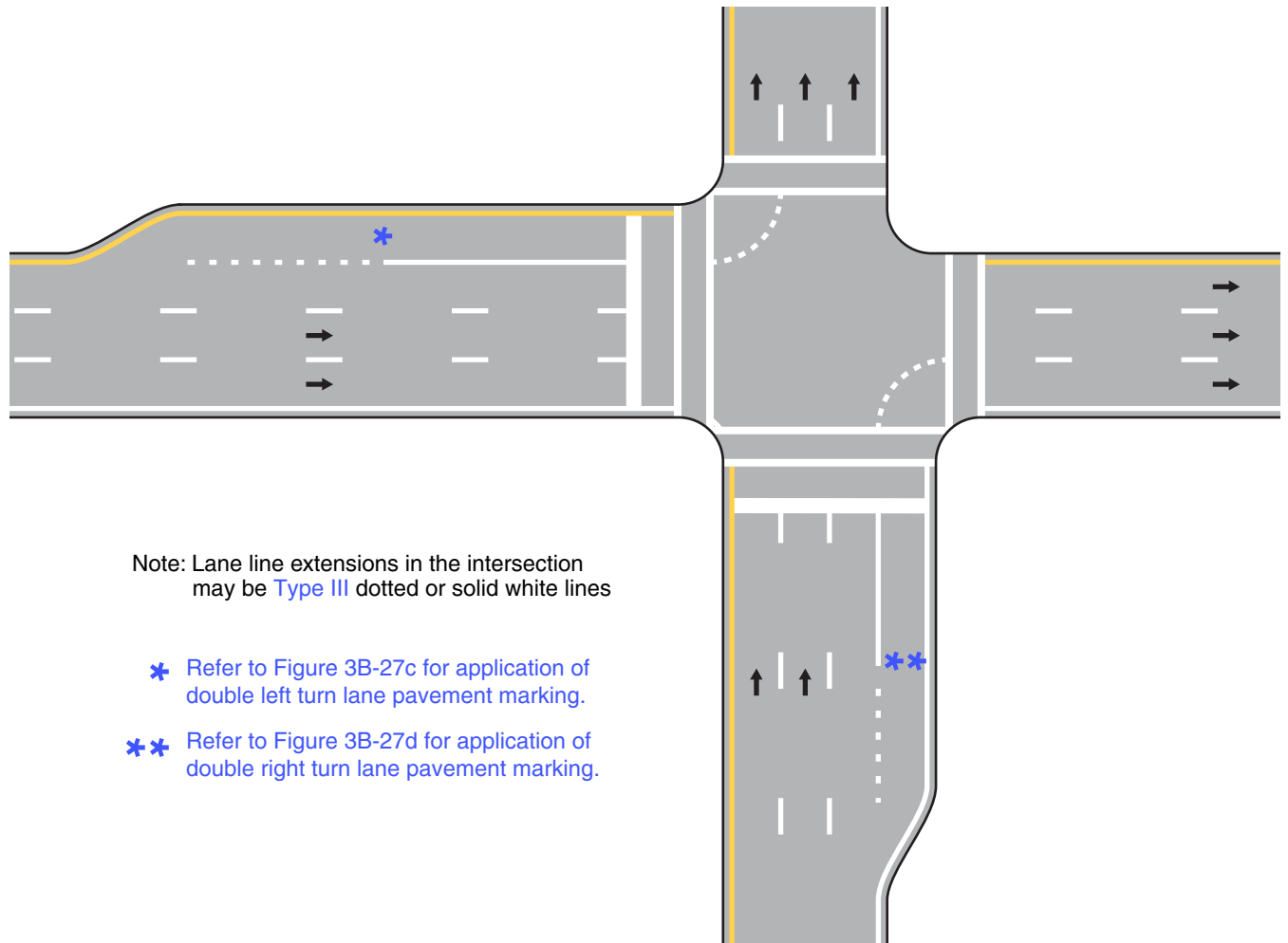
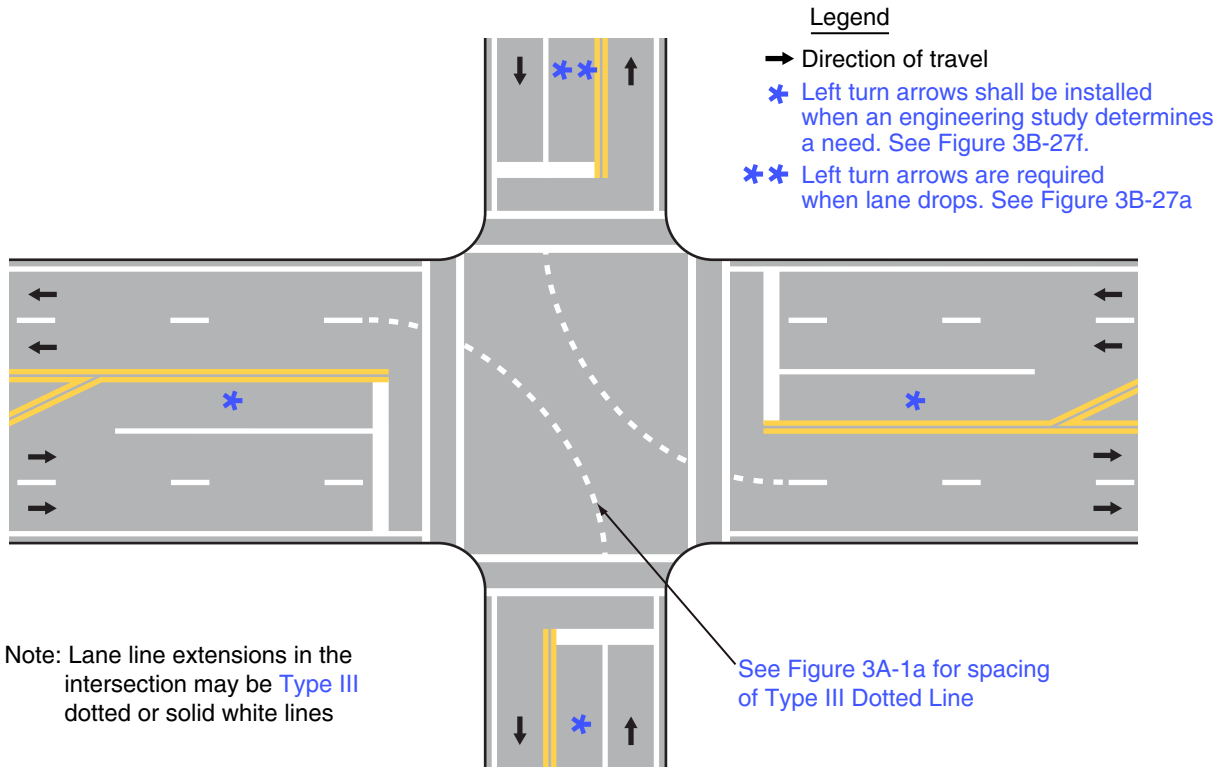

Figure 3B-13. Examples of Line Extensions through Intersections (Sheet 2 of 4)

C - Typical dotted line markings to extend lane line markings into the intersection



D - Typical dotted line markings to extend center line and lane line markings into the intersection

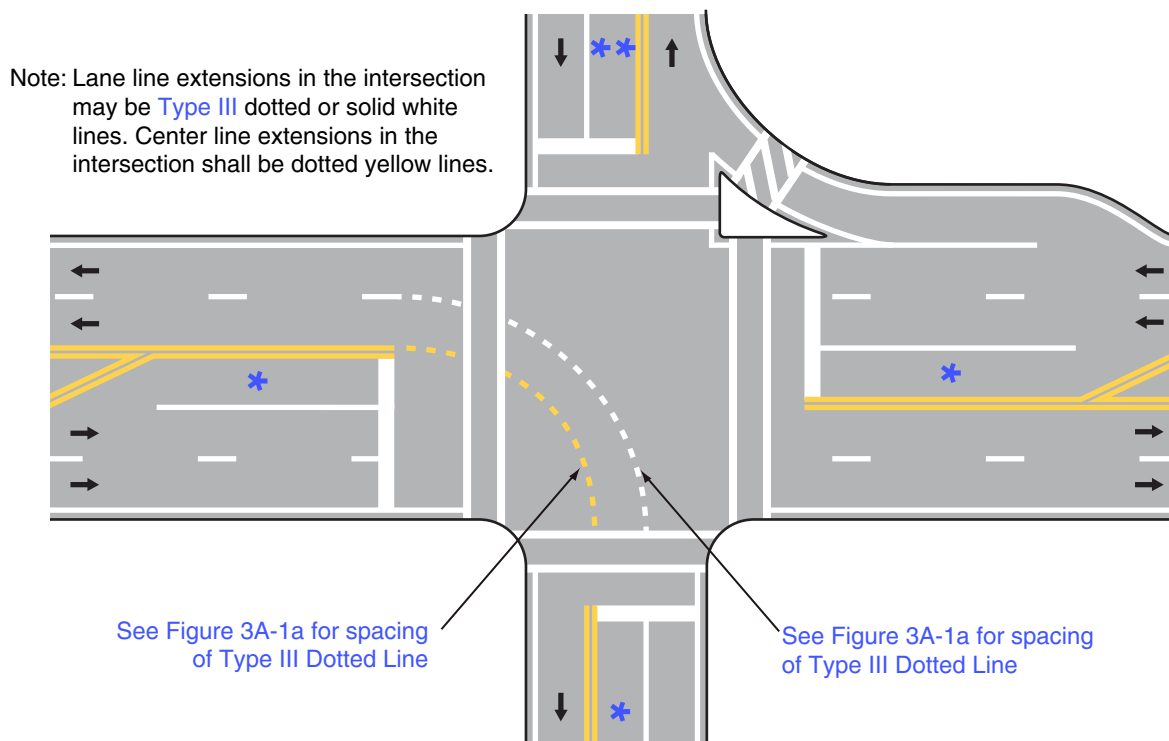

Figure 3B-13. Examples of Line Extensions through Intersections (Sheet 3 of 4)

**E - Typical dotted line markings to extend longitudinal lane line markings
- with Median**

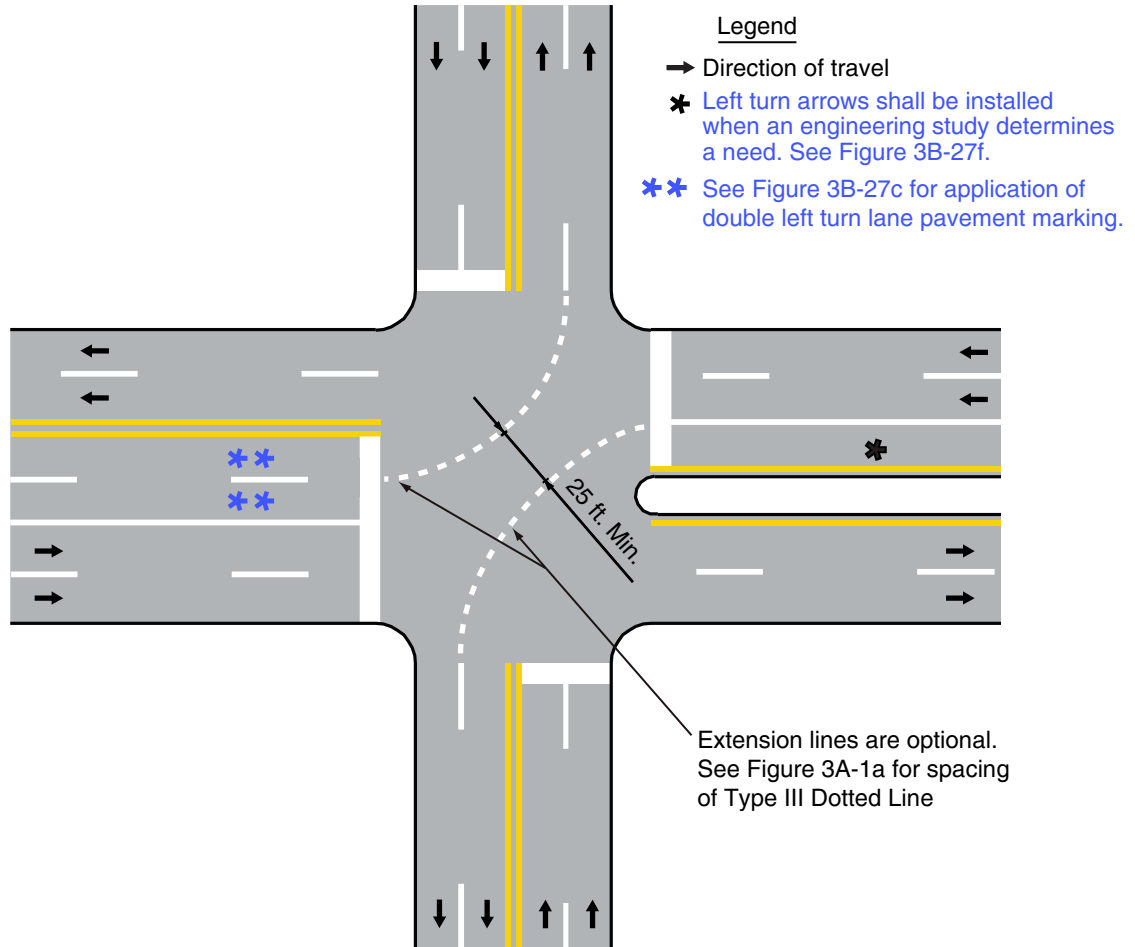

Figure 3B-13. Examples of Line Extensions through Intersections (Sheet 4 of 4)

F - Typical pavement markings with offset center line and lane lines continued through the intersection, double-turn lane lines, lane-use turn arrows, crosswalk lines, and stop lines

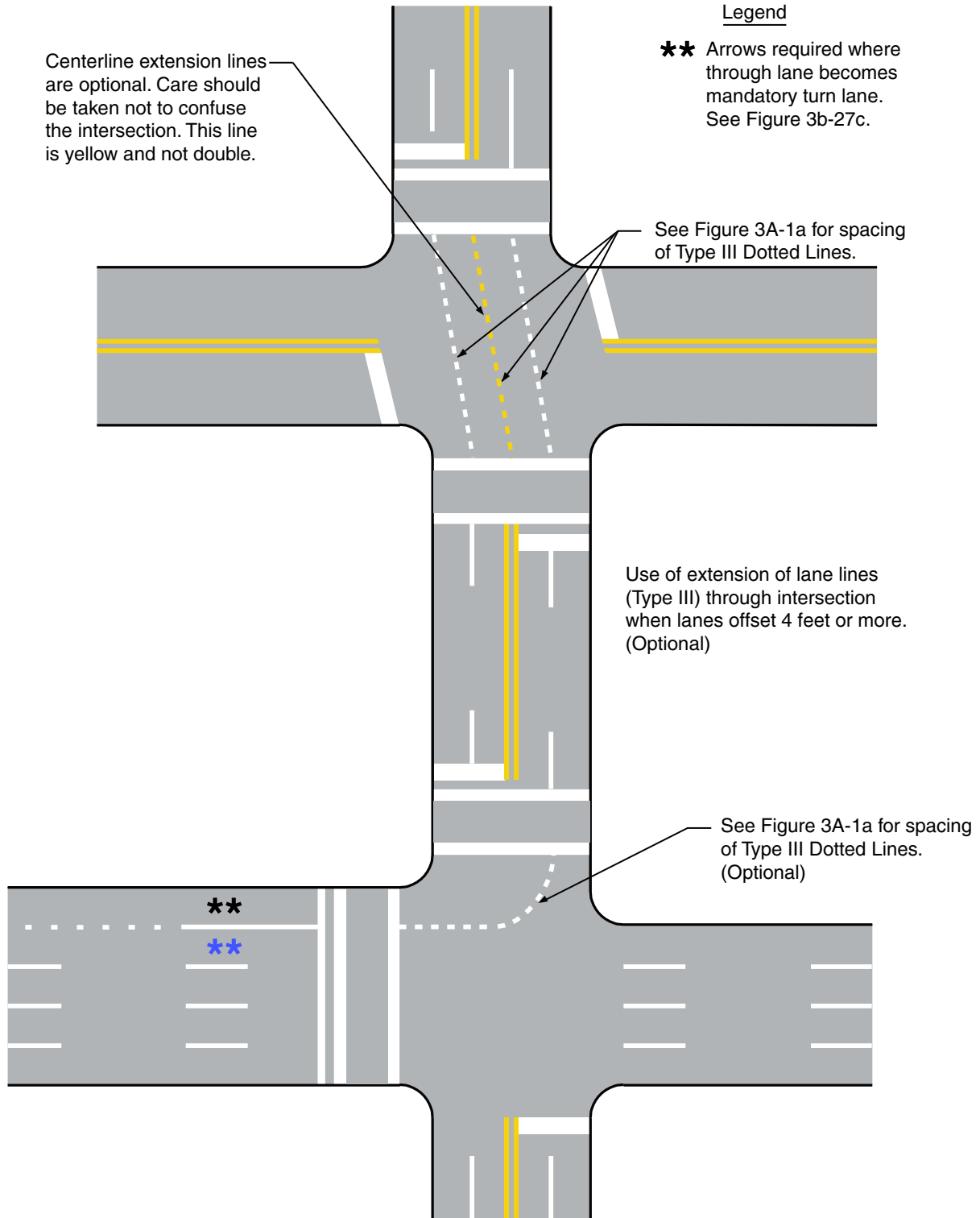
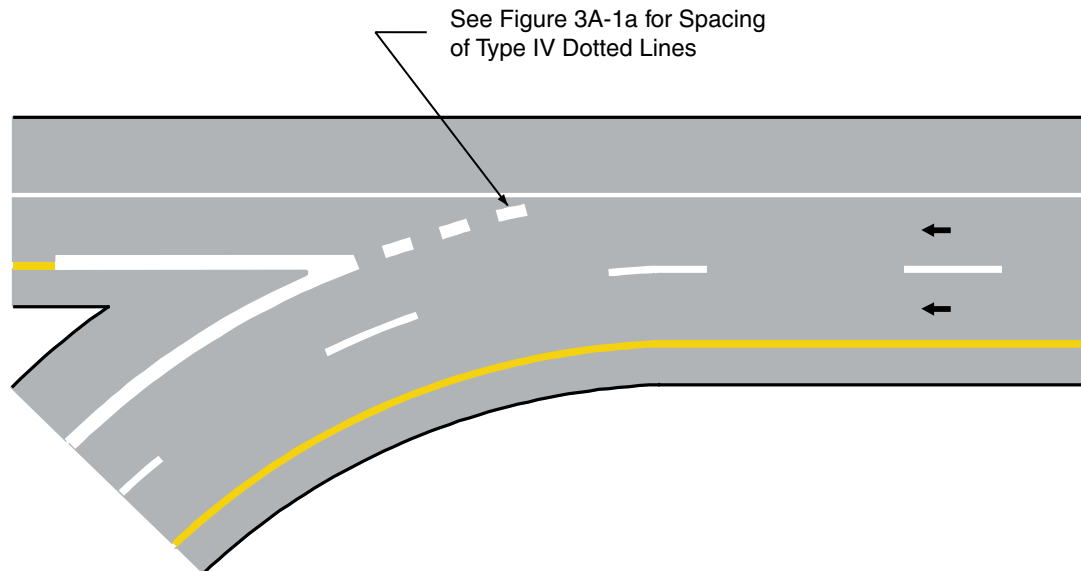

Figure 3B-13a. Examples of Extensions for Expressways / Freeways

03a **If used, the details and placement of the lane reduction transition arrow shall conform to Figures 3B-14c and 3B-14d.**

Option:

03 On low-speed urban roadways where curbs clearly define the roadway edge in the lane-reduction transition, or where a through lane becomes a parking lane, the edge line and/or delineators shown in Figure 3B-14 may be omitted as determined by engineering judgment.

Guidance:

04 For roadways having a posted or statutory speed limit of 45 mph or greater, the transition taper length for a lane-reduction transition should be computed by the formula $L = WS$. For roadways where the posted or statutory speed limit is less than 45 mph, the formula $L = WS^2/60$ should be used to compute the taper length.

04a For freeway and expressways, Type II dotted line markings should be extended from half of the distance between the first and the second Lane Ends signs to the point where the transition taper begins (See Figure 3B-14a).

Support:

05 Under both formulas, L equals the taper length in feet, W equals the width of the offset distance in feet, and S equals the 85th-percentile speed or the posted or statutory speed limit, whichever is higher.

Guidance:

06 Where observed speeds exceed posted or statutory speed limits, longer tapers should be used.

Option:

07 On new construction, where no posted or statutory speed limit has been established, the design speed may be used in the transition taper length formula.

Guidance:

08 Lane line markings should be discontinued one-quarter of the distance between the Lane Ends sign (see Section 2C.42) and the point where the transition taper begins.

08a Along State owned, operated, and maintained roadway, lane line markings should be discontinued at the point where the transition taper begins (see Figure 3B-14).

09 Except as provided in Paragraph 3 for low-speed urban roadways, the edge line markings shown in Figure 3B-14 should be installed from the location of the Lane Ends warning sign to beyond the beginning of the narrower roadway.

Support:

10 Pavement markings at lane-reduction transitions supplement the standard signs. See Section 3B.20 for provisions regarding use of lane-reduction arrows.

Figure 3B-14. Examples of Applications of Lane-Reduction Transition Markings

A – Lane reduction

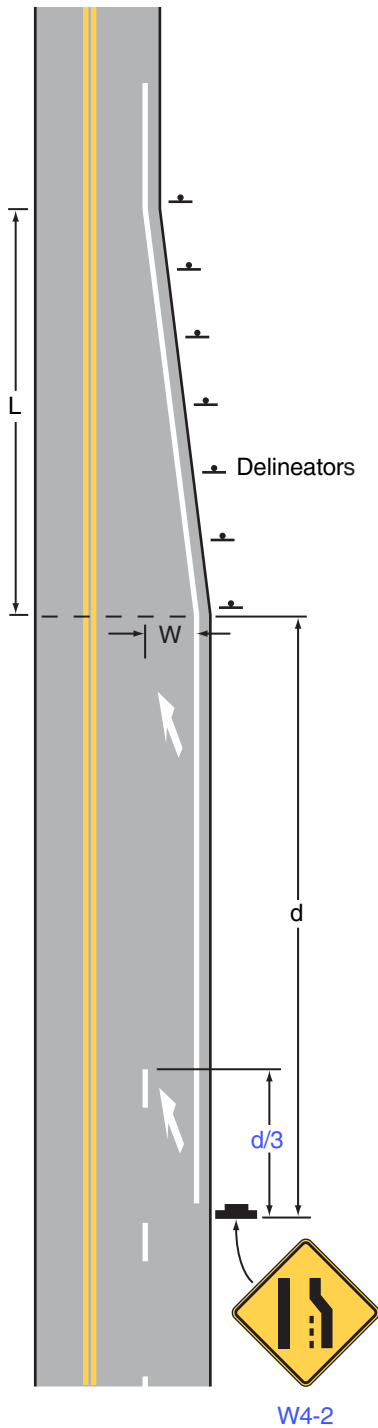

B – Lane reduction with lateral shift to the left

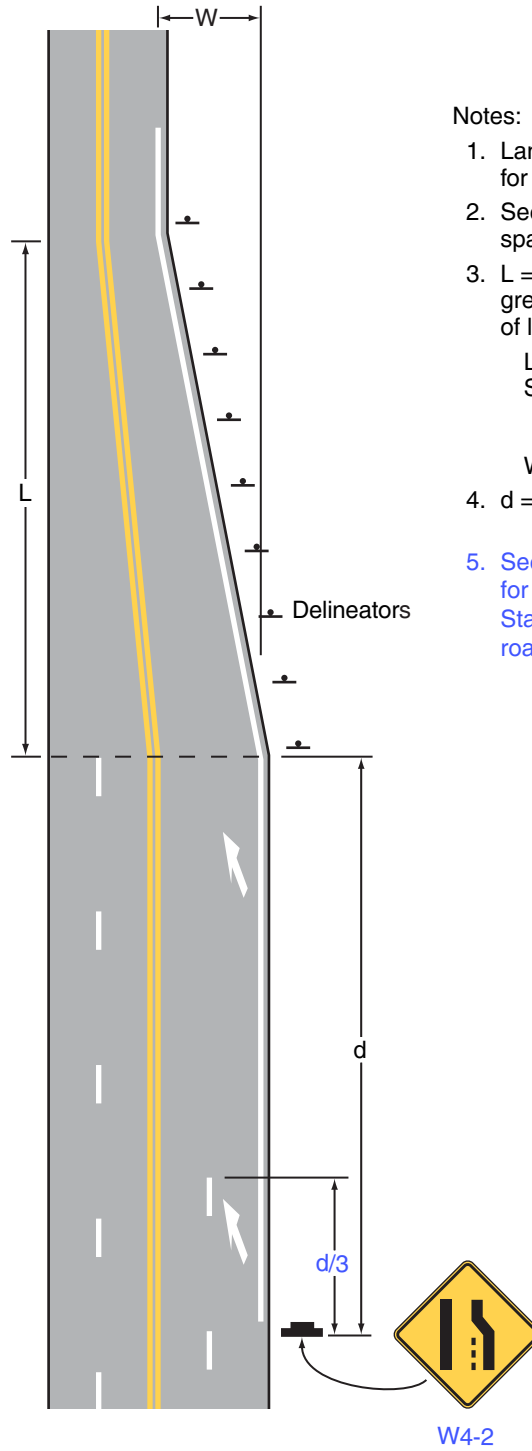

Notes:

1. Lane-reduction arrows are optional for speeds of less than 45 mph
2. See Section 3F.04 for delineator spacing
3. $L = WS$ for speeds of 45 mph or greater and $L = WS^2/60$ for speeds of less than 45 mph, where:
 L = Length of taper in feet
 S = Posted, off peak 85th-percentile, or statutory speed in mph, whichever is greater
 W = Offset in feet
4. d = Advance warning distance (see Section 2C.05)
5. See Figure 3B-14a and Figure 3B-14b for preferred applications for use along State owned, operated and maintained roadways.

Figure 3B-14a. Examples of Lane Reduction Transition - Expressway

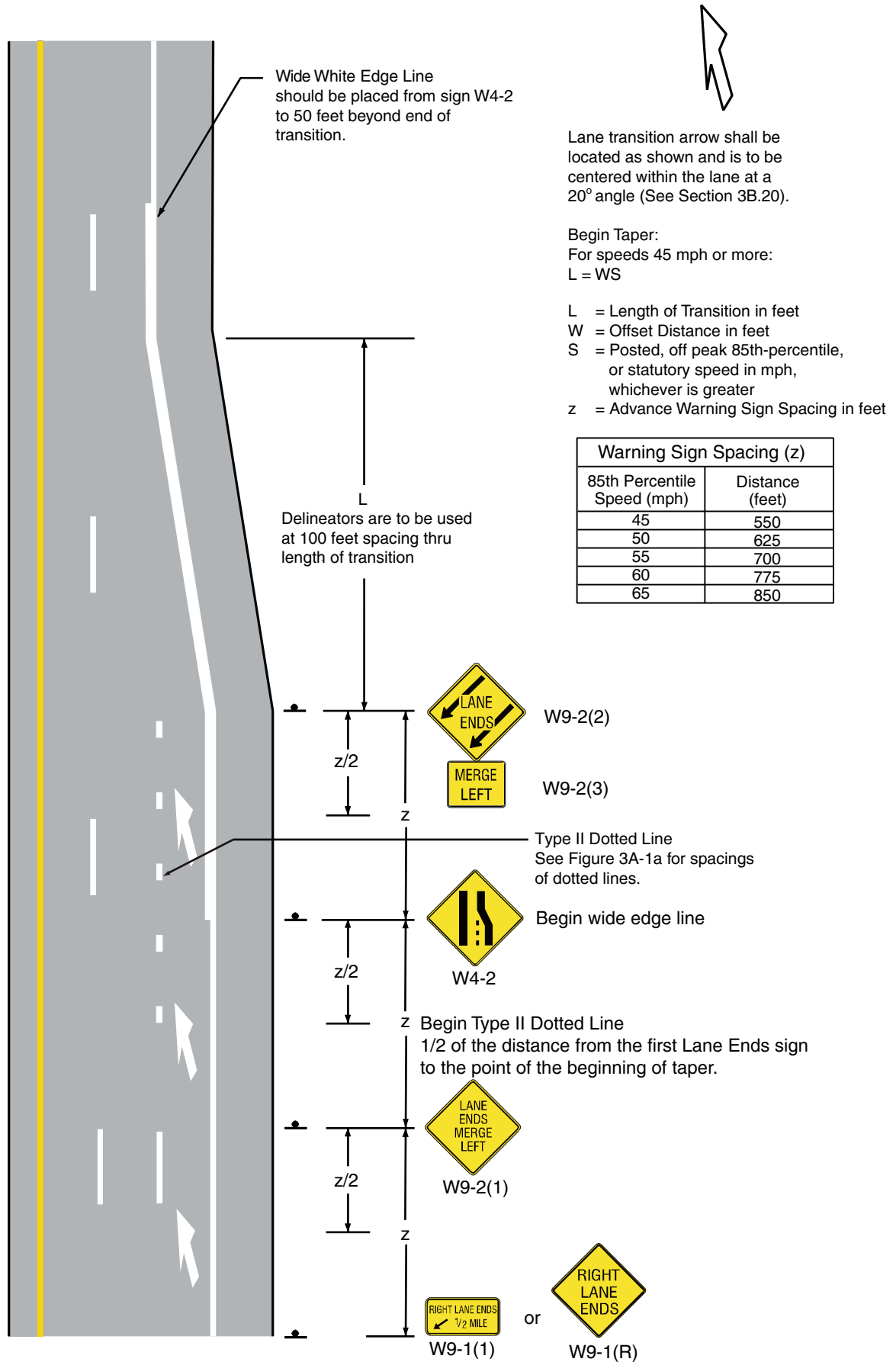
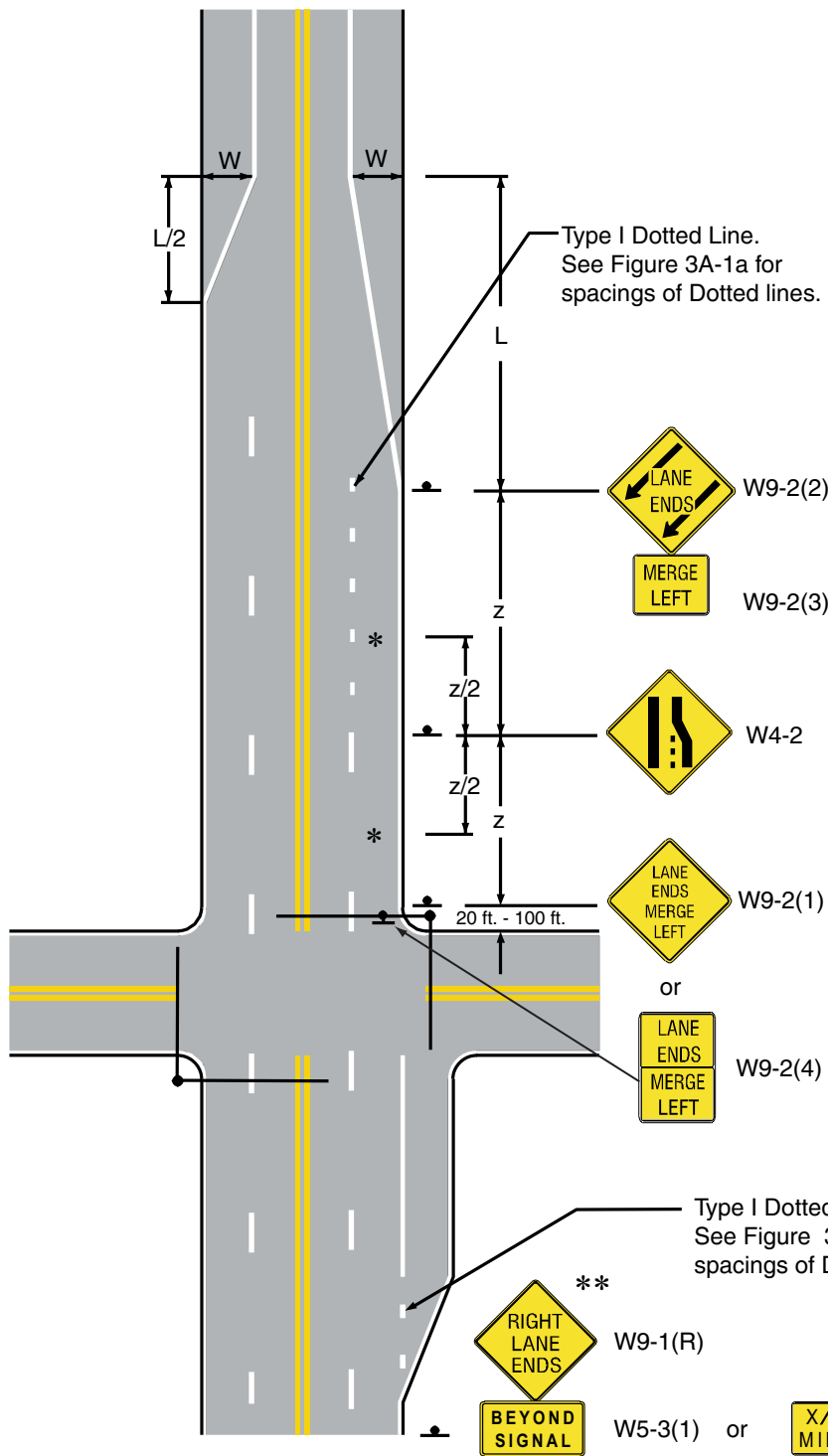

Figure 3B-14b. Examples of Intermediate Intersection Lane Reduction Marking - Divided and Undivided Roadways



Begin Taper:

For speeds 45 mph or more:

$$L = WS$$

For speeds less than 45 mph:

$$L = WS^2 / 60$$

L = Length of Transition in feet

W = Offset Distance in feet

S = Posted, off peak 85th-percentile, or statutory speed in mph, whichever is greater

z = Advance Warning Sign Spacing in feet

Warning Sign Spacing (z)

85th Percentile Speed (mph)	Distance (feet)
20	175
25	250
30	325
35	400
40	475
45	550
50	625
55	700
60	775
65	850

* Lane Transition Arrows are not used if 85th Percentile Speed < 45 mph. If used, lane transition arrow shall be located as shown and is to be centered within the lane at a 20° angle (See Section 3B.20).

** Optional, based on engineering judgement.

The length of the auxiliary lane should be determined by referencing the latest edition of AASHTO's "A Policy on Geometric Design of Highways and Streets".

Figure 3B-14c. Examples of Lane Reduction Transition Arrow Detail

a - Left Lane Transition Arrow

b - Right Lane Transition Arrow

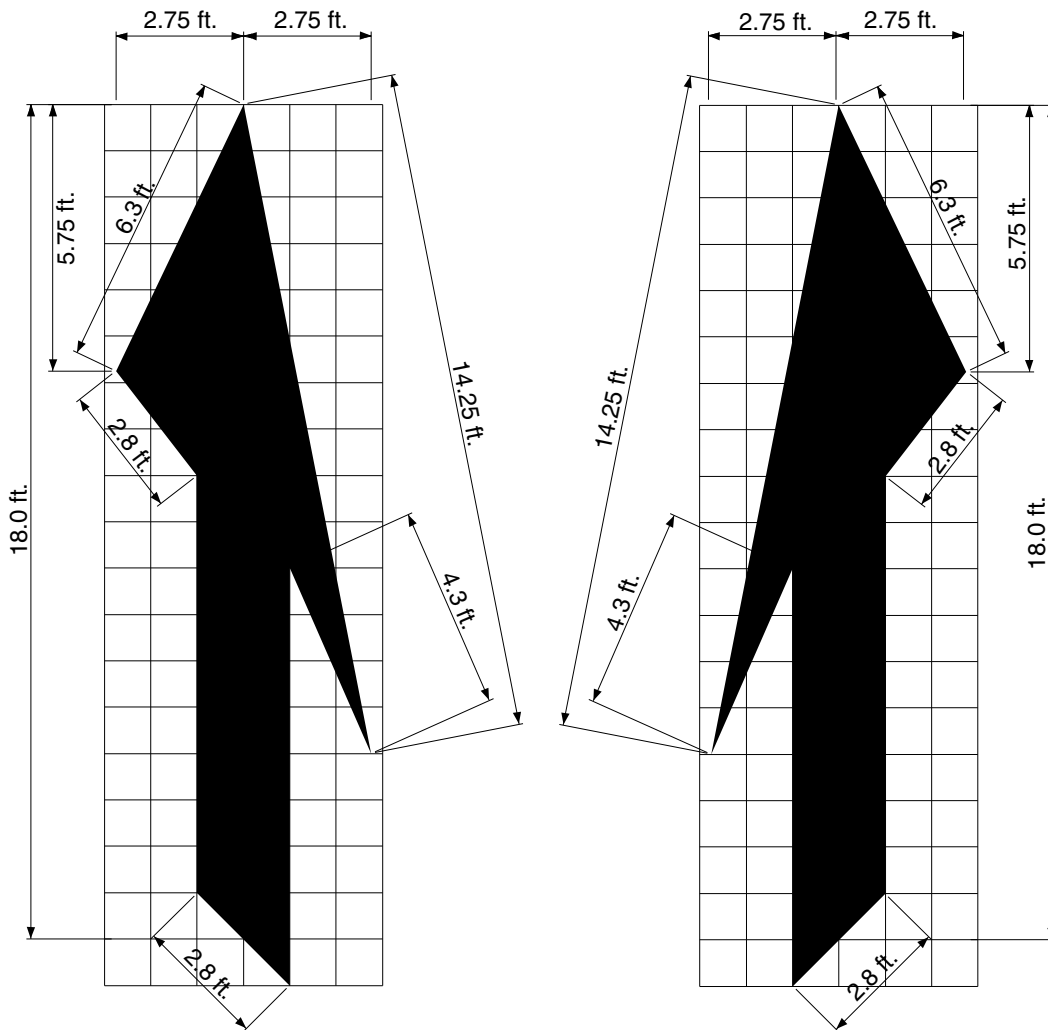

12 inches Grid
Area = 42 ft²

Figure 3B-14d. Examples of Lane Reduction Transition Arrow Placement.

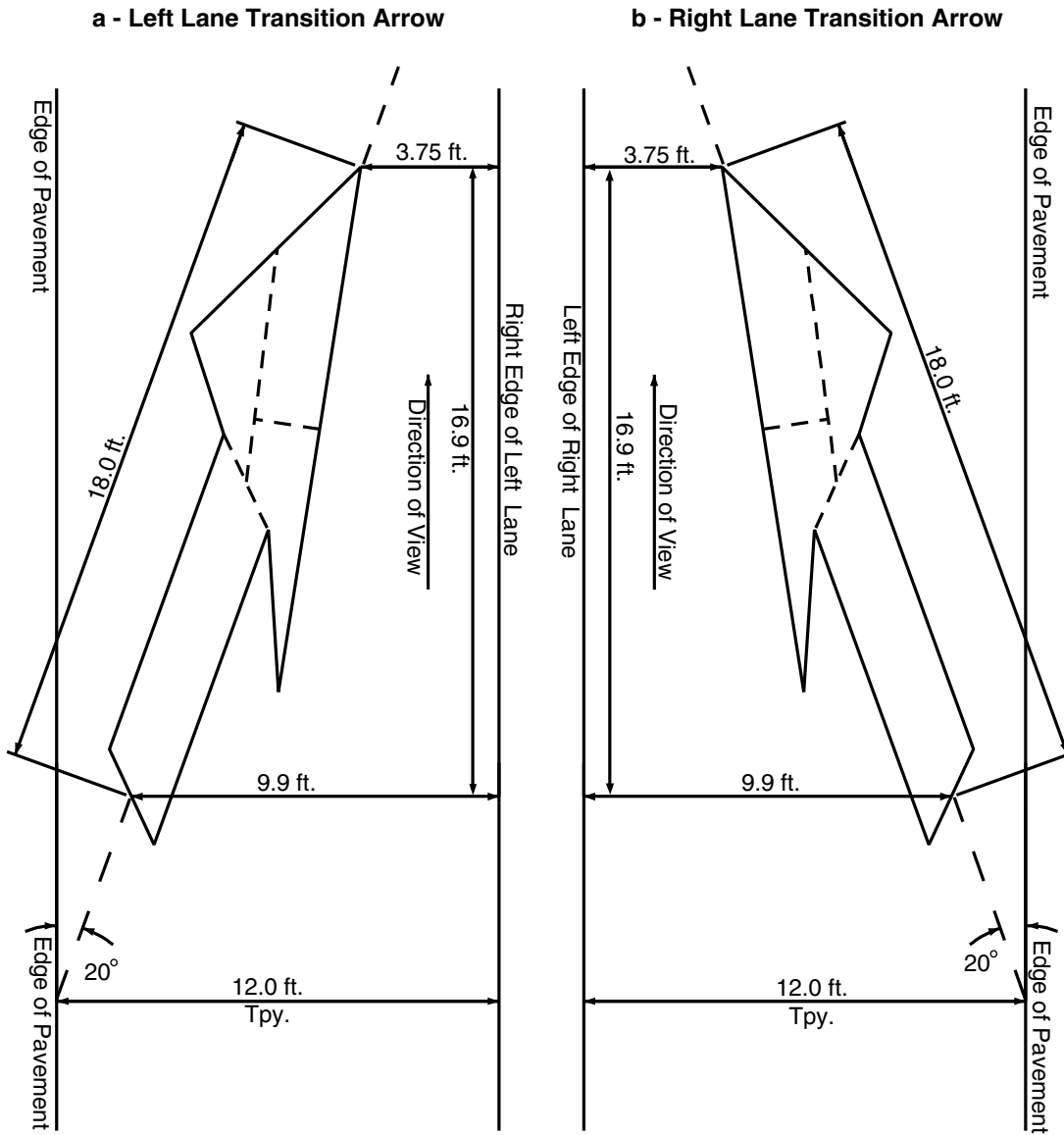

NOTE:
 Broken lines (---) illustrate the four (4) typical lane transition pavement marking arrow pieces.

Section 3B.10 Approach Markings for Obstructions

Standard:

- 01 **Pavement markings shall be used to guide traffic away from fixed obstructions within a paved roadway. Approach markings for bridge supports, refuge islands, median islands, toll plaza islands, and raised channelization islands shall consist of a tapered line or lines extending from the center line or the lane line to a point 1 to 2 feet to the right-hand side, or to both sides, of the approach end of the obstruction (see Figure 3B-15).**

Support:

- 02 See Chapter 3E for additional information on approach markings for toll plaza islands.

Guidance:

- 03 *For roadways having a posted or statutory speed limit of 45 mph or greater, the taper length of the tapered line markings should be computed by the formula $L = WS$. For roadways where the posted or statutory speed limit is less than 45 mph, the formula $L = WS^2/60$ should be used to compute the taper length.*

Support:

- 04 Under both formulas, L equals the taper length in feet, W equals the width of the offset distance in feet, and S equals the 85th-percentile speed or the posted or statutory speed limit, whichever is higher.

Guidance:

- 05 *The minimum taper length should be 100 feet in urban areas and 200 feet in rural areas.*

Support:

- 06 Examples of approach markings for obstructions in the roadway are shown in Figure 3B-15.

Standard:

- 07 **If traffic is required to pass only to the right of the obstruction, the markings shall consist of a two-direction no-passing zone marking at least twice the length of the diagonal portion as determined by the appropriate taper formula (see Drawing A of Figure 3B-15).**

Option:

- 08 If traffic is required to pass only to the right of the obstruction, yellow diagonal crosshatch markings (see Section 3B.24) may be placed in the flush median area between the no-passing zone markings as shown in Drawings A and B of Figure 3B-15. Other markings, such as yellow delineators, yellow channelizing devices, yellow raised pavement markers, and white crosswalk pavement markings, may also be placed in the flush median area.

Standard:

- 09 **If traffic can pass either to the right or left of the obstruction, the markings shall consist of two channelizing lines diverging from the lane line, one to each side of the obstruction. In advance of the point of divergence, a wide solid white line or normal solid double white line shall be extended in place of the broken lane line for a distance equal to the length of the diverging lines (see Drawing C of Figure 3B-15).**

Option:

- 10 If traffic can pass either to the right or left of the obstruction, additional white chevron crosshatch markings (see Section 3B.24) may be placed in the flush median area between the channelizing lines as shown in Drawing C of Figure 3B-15. Other markings, such as white delineators, white channelizing devices, white raised pavement markers, and white crosswalk markings may also be placed in the flush median area.

Section 3B.11 Raised Pavement Markers – General

Standard:

- 01 **The color of raised pavement markers under both daylight and nighttime conditions shall conform to the color of the marking for which they serve as a positioning guide, or for which they supplement or substitute.**

Option:

- 02 The side of a raised pavement marker that is visible to traffic proceeding in the wrong direction may be red (see Section 3A.05).

- 03 Retroreflective or internally illuminated raised pavement markers may be used in the roadway immediately adjacent to curbed approach ends of raised medians and curbs of islands, or on top of such curbs (see Section 3B.23)

Figure 3B-15. Examples of Applications of Markings for Obstructions in the Roadway
(Sheet 1 of 2)

A - Center of a two-lane road

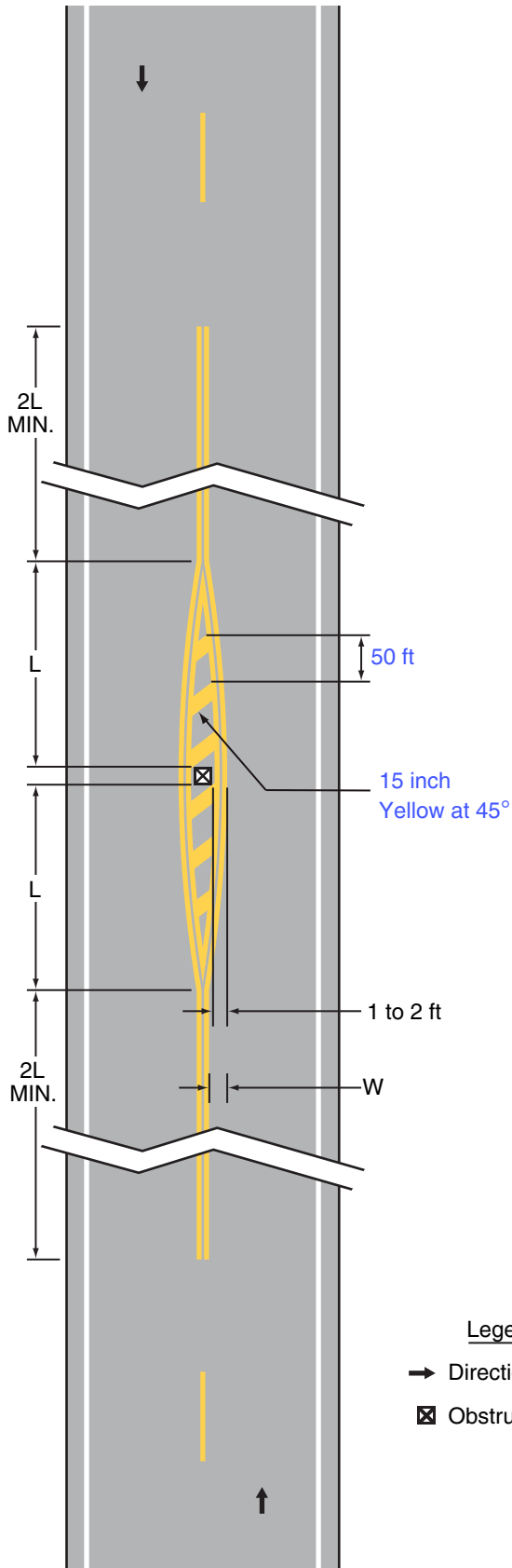

B - Center of a four-lane road

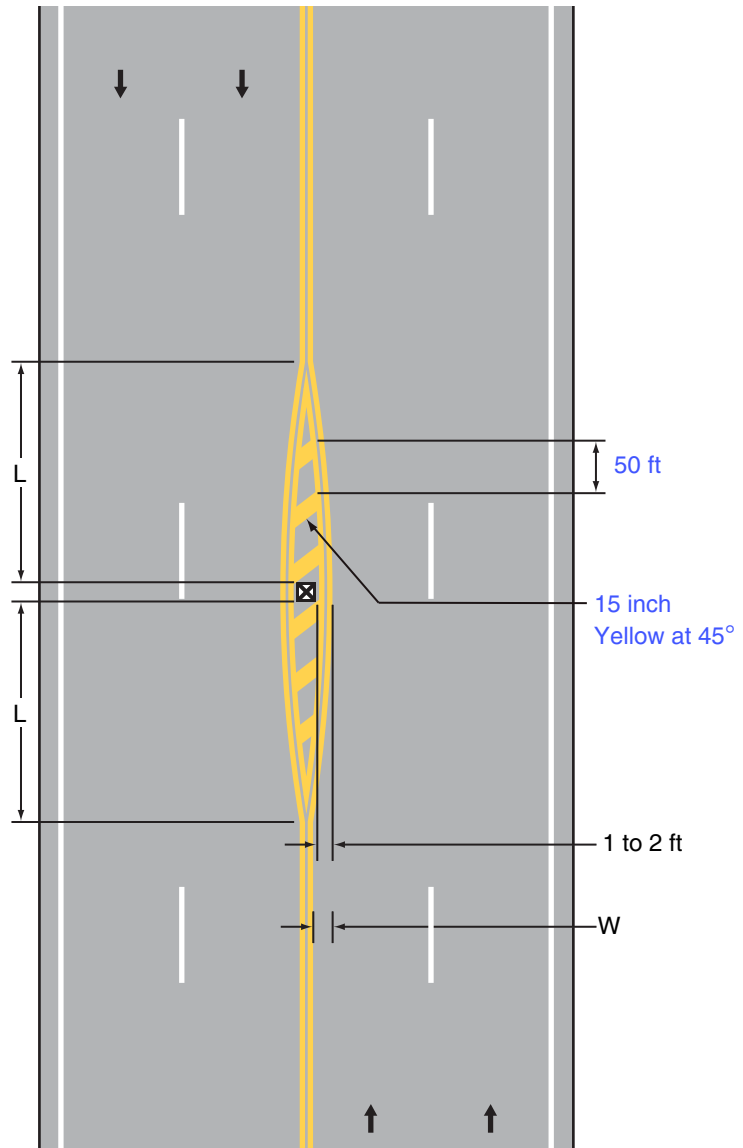

For speeds 45 mph or more: $L = WS$
 For speeds less than 45 mph: $L = WS^2/60$
 S = Posted, 85th-percentile, or statutory speed in mph
 W = Offset distance in feet

Legend

- Direction of travel
- ⊠ Obstruction

Minimum length of : $L = 100$ feet in urban areas
 $L = 200$ feet in rural areas

Length "L" should be extended as required by sight distance conditions

Figure 3B-15. Examples of Applications of Markings for Obstructions in the Roadway
(Sheet 2 of 2)

C - Traffic passing in the same direction on both sides of an obstruction

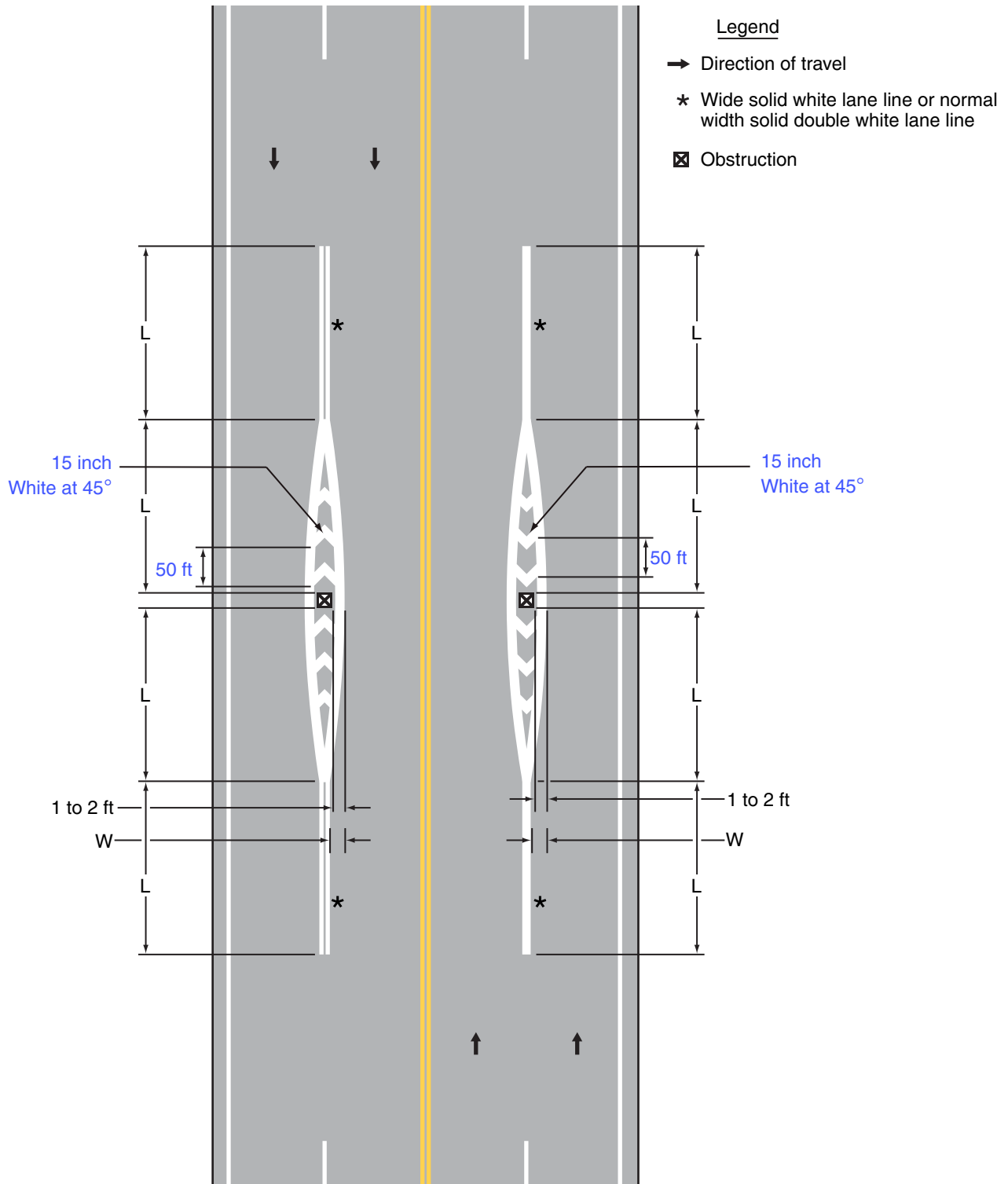

For speeds of 45 mph or more: $L = WS$
 For speeds of less than 45 mph: $L = WS^2/60$
 S = Posted, 85th-percentile, or statutory speed in mph
 W = Offset distance in feet

Minimum length of: L = 100 feet in urban areas
 L = 200 feet in rural areas

Length "L" should be extended as required by sight distance conditions

Support:

04 Retroreflective and internally illuminated raised pavement markers are available in mono-directional and bidirectional configurations. The bidirectional marker is capable of displaying the applicable color for each direction of travel.

05 Blue raised pavement markers are sometimes used in the roadway to help emergency personnel locate fire hydrants.

Standard:

06 **When used, internally illuminated raised pavement markers shall be steadily illuminated and shall not be flashed.**

Support:

07 [Flashing raised pavement markers are not used in Maryland.](#)

Guidance:

08 *Non-retroreflective raised pavement markers should not be used alone, without supplemental retroreflective or internally illuminated markers, as a substitute for other types of pavement markings.*

09 *Directional configurations should be used to maximize correct information and to minimize confusing information provided to the road user. Directional configurations also should be used to avoid confusion resulting from visibility of markers that do not apply to the road user.*

10 *The spacing of raised pavement markers used to supplement or substitute for other types of longitudinal markings should correspond with the pattern of broken lines for which the markers supplement or substitute.*

Standard:

11 **The value of N cited in Sections 3B.12 through 3B.14 for the spacing of raised pavement markers shall equal the length of one line segment plus one gap of the broken lines used on the highway.**

Option:

12 For additional emphasis, retroreflective raised pavement markers may be spaced closer than described in Sections 3B.12 through 3B.14, as determined by engineering judgment or engineering study.

Support:

13 Figures 9-20 through 9-22 in the “Traffic Control Devices Handbook” (see Section 1A.11) contain additional information regarding the spacing of raised pavement markers on longitudinal markings.

13a [The “Raised Pavement Marker Guidelines” contains further information regarding the application of RPM’s. This guideline can be obtained from the Maryland State Highway Administration’s Office of Traffic & Safety, Traffic Development & Support Division \(TDSD\) at the address shown on Page i.](#)

Section 3B.12 Raised Pavement Markers as Vehicle Positioning Guides with Other Longitudinal Markings**Option:**

01 Retroreflective or internally illuminated raised pavement markers may be used as positioning guides with longitudinal line markings without necessarily conveying information to the road user about passing or lane-use restrictions. In such applications, markers may be positioned in line with or immediately adjacent to a single line marking or positioned between the two lines of a double center line or double lane line marking.

Guidance:

02 *The spacing for such applications should be $2N$, where N equals the length of one line segment plus one gap (see Section 3B.11).*

Option:

03 Where it is desired to alert the road user to changes in the travel path, such as on sharp curves or on transitions that reduce the number of lanes or that shift traffic laterally, the spacing may be reduced to N or less.

04 On freeways and expressways, the spacing may be increased to $3N$ for relatively straight and level roadway segments where engineering judgment indicates that such spacing will provide adequate delineation under wet night conditions.

Section 3B.13 Raised Pavement Markers Supplementing Other Markings**Guidance:**

01 *The use of retroreflective or internally illuminated raised pavement markers for supplementing longitudinal line markings should comply with the following:*

A. *Lateral Positioning*

1. *When supplementing double line markings, pairs of raised pavement markers placed laterally in line with or immediately outside of the two lines should be used.*
2. *When supplementing wide line markings, pairs of raised pavement markers placed laterally adjacent to each other should be used.*

B. *Longitudinal Spacing*

1. *When supplementing solid line markings, raised pavement markers at a spacing no greater than N (see Section 3B.11) should be used, that when supplementing channelizing lines or edge line markings, a spacing of no greater than N/2 should be used.*
2. *When supplementing broken line markings, a spacing no greater than 3N should be used. However, when supplementing broken line markings identifying reversible lanes, a spacing of no greater than N should be used.*
3. *When supplementing dotted lane line markings, a spacing appropriate for the application should be used.*
4. *When supplementing longitudinal line extension markings through at-grade intersections, one raised pavement marker for each short line segment should be used.*
5. *When supplementing line extensions through freeway interchanges, a spacing of no greater than N should be used.*

02 *Raised pavement markers should not supplement right-hand edge lines unless an engineering study or engineering judgment indicates the benefits of enhanced delineation of a curve or other location would outweigh possible impacts on bicycles using the shoulder, and the spacing of raised pavement markers on the right-hand edge is close enough to avoid misinterpretation as a broken line during wet night conditions.*

Option:

03 Raised pavement markers also may be used to supplement other markings such as channelizing islands, gore areas, approaches to obstructions, or wrong-way arrows.

04 To improve the visibility of horizontal curves, center lines may be supplemented with retroreflective or internally illuminated raised pavement markers for the entire curved section as well as for a distance in advance of the curve that approximates 5 seconds of travel time.

Section 3B.14 Raised Pavement Markers Substituting for Pavement Markings

Option:

01 Retroreflective or internally illuminated raised pavement markers, or non-retroreflective raised pavement markers supplemented by retroreflective or internally illuminated markers, may be substituted for markings of other types.

Guidance:

02 *If used, the pattern of the raised pavement markers should simulate the pattern of the markings for which they substitute.*

Standard:

03 **If raised pavement markers are used to substitute for broken line markings, a group of three to five markers equally spaced at a distance no greater than N/8 (see Section 3B.11) shall be used. If N is other than 40 feet, the markers shall be equally spaced over the line segment length (at 1/2 points for three markers, at 1/3 points for four markers, and at 1/4 points for five markers). At least one retroreflective or internally illuminated marker per group shall be used or a retroreflective or internally illuminated marker shall be installed midway in each gap between successive groups of non-retroreflective markers.**

04 **When raised pavement markers substitute for solid line markings, the markers shall be equally spaced at no greater than N/4, with retroreflective or internally illuminated units at a spacing no greater than N/2.**

Guidance:

05 *Raised pavement markers should not substitute for right-hand edge line markings unless an engineering study or engineering judgment indicates the benefits of enhanced delineation of a curve or other location would outweigh possible impacts on bicycles using the shoulder, and the spacing of raised pavement markers on the right-hand edge line is close enough to avoid misinterpretation as a broken line during wet night conditions.*

Standard:

06 **When raised pavement markers substitute for dotted lines, they shall be spaced at no greater than N/4, with not less than one raised pavement marker per dotted line segment. At least one raised marker every N shall be retroreflective or internally illuminated.**

Option:

- 07 When substituting for wide lines, raised pavement markers may be placed laterally adjacent to each other to simulate the width of the line.

Section 3B.15 Transverse Markings

Standard:

- 01 **Transverse markings, which include shoulder markings, word and symbol markings, arrows, stop lines, yield lines, crosswalk lines, speed measurement markings, speed reduction markings, speed hump markings, parking space markings, and others, shall be white unless otherwise provided in this Manual.**

Guidance:

- 02 *Because of the low approach angle at which pavement markings are viewed, transverse lines should be proportioned to provide visibility at least equal to that of longitudinal lines.*

Section 3B.16 Stop and Yield Lines

Guidance:

- 01 *Stop lines should be used to indicate the point behind which vehicles are required to stop in compliance with a traffic control signal.*

Option:

- 02 Stop lines may be used to indicate the point behind which vehicles are required to stop in compliance with a STOP (R1-1) sign, a Stop Here For Pedestrians (R1-5b or R1-5c) sign, or some other traffic control device that requires vehicles to stop, except YIELD signs that are not associated with passive grade crossings.

- 03 Yield lines may be used to indicate the point behind which vehicles are required to yield in compliance with a YIELD (R1-2) sign or a Yield Here To Pedestrians (R1-5 or R1-5a) sign.

Standard:

- 04 **Except as provided in Section 8B.28, stop lines shall not be used at locations where drivers are required to yield in compliance with a YIELD (R1-2) sign or a Yield Here To Pedestrians (R1-5 or R1-5a) sign or at locations on uncontrolled approaches where drivers are required by State law to yield to pedestrians.**

- 05 **Yield lines shall not be used at locations where drivers are required to stop in compliance with a STOP (R1-1) sign, a Stop Here For Pedestrians (R1-5b or R1-5c) sign, a traffic control signal, or some other traffic control device.**

- 06 **Stop lines shall consist of solid white lines extending across approach lanes to indicate the point at which the stop is intended or required to be made.**

- 07 **Yield lines (see Figure 3B-16) shall consist of a row of solid white isosceles triangles pointing toward approaching vehicles extending across approach lanes to indicate the point at which the yield is intended or required to be made.**

Guidance:

- 08 *Stop lines should be 12 to 24 inches wide.*

- 08a *On State owned, operated, and maintained roadways, stop lines should be 16 inches or 24 inches wide.*

- 09 *The individual triangles comprising the yield line should have a base of 12 to 24 inches wide and a height equal to 1.5 times the base. The space between the triangles should be 3 to 12 inches.*

- 10 *If used, stop and yield lines should be placed a minimum of 4 feet in advance of the nearest crosswalk line at controlled intersections, except for yield lines at roundabouts as provided for in Section 3C.04 and at midblock crosswalks. In the absence of a marked crosswalk, the stop line or yield line should be placed at the desired stopping or yielding point, but should not be placed more than 30 feet or less than 4 feet from the nearest edge of the intersecting traveled way.*

- 10a *When used, Stop lines should be placed parallel to the intersecting roadway if there are no crosswalk lines. If there are crosswalk lines, the Stop line should be parallel to the crosswalk. See Figure 3B-19.*

- 10b *When necessary to add emphasis to a YIELD sign, or to mark the location where a stop might be made in compliance with a motorist's responsibility at a YIELD sign, a Yield line should be used (Figure 3B-19a). The yield line should be used at the approach to the second roadway of a divided highway or entrance to a roundabout, whether the approach is marked with a YIELD sign, or not controlled by either a STOP sign or a YIELD sign (Figure 3B-19b).*

- 11 *Stop lines at midblock signalized locations should be placed at least 40 feet in advance of the nearest signal indication (see Section 4D.14).*

- 11a *Edge line extension pavement markings should be installed at ramps where merge areas are not provided (see Figure 3B-19c).*
 - 12 *If stop lines are used at a crosswalk that crosses an uncontrolled multi-lane approach, the stop lines should be placed 20 to 50 feet in advance of the nearest crosswalk line, and parking should be prohibited in the area between the stop line and the crosswalk (see Figure 3B-17).*
- Standard:**
- 13 **If stop lines are used at a crosswalk that crosses an uncontrolled multi-lane approach, Stop Here For Pedestrians (R1-5 series) signs (see Section 2B.11) shall be used.**
- Guidance:*
- 14 *Stop lines and Stop Here For Pedestrians signs should not be used in advance of crosswalks that cross an approach to or departure from a roundabout.*
- Support:**
- 15 When drivers stop too close to crosswalks that cross uncontrolled multi-lane approaches, they place pedestrians at risk by blocking other drivers' views of pedestrians and by blocking pedestrians' views of vehicles approaching in the other lanes.
- Option:**
- 16 Stop lines may be staggered longitudinally on a lane-by-lane basis.
- Support:**
- 17 Staggered stop lines can improve the driver's view of pedestrians, provide better sight distance for turning vehicles, and increase the turning radius for left-turning vehicles.
 - 18 Section 8B.28 contains information regarding the use of stop lines at grade crossings.



Figure 3B-16. Recommended Yield Line Layouts

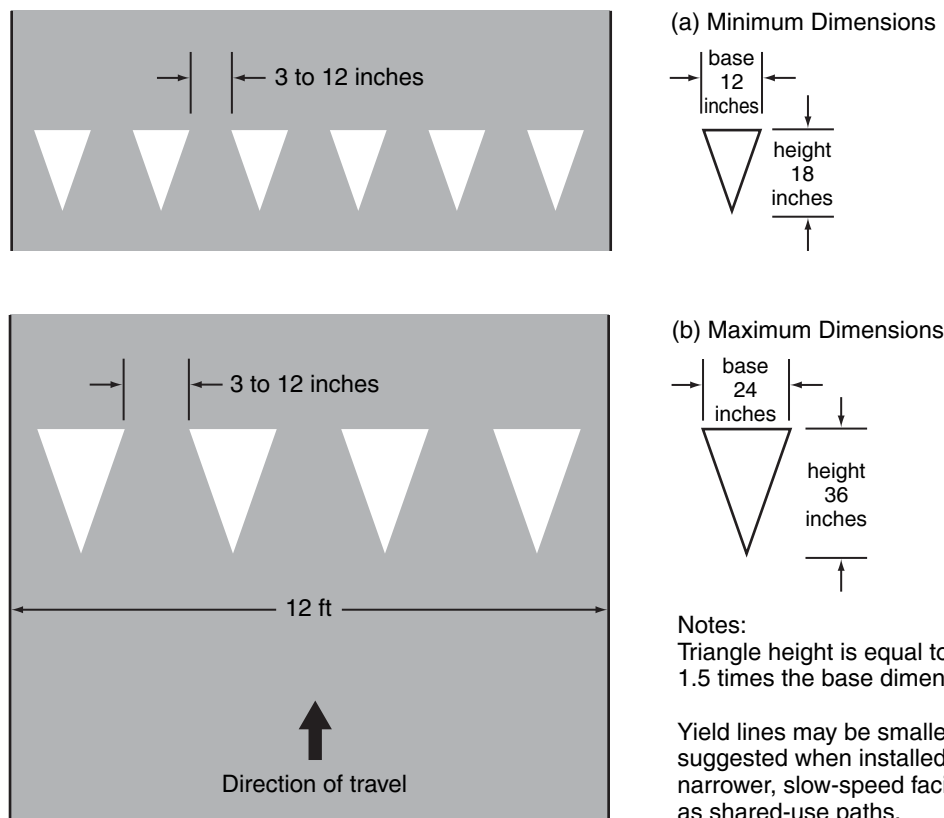
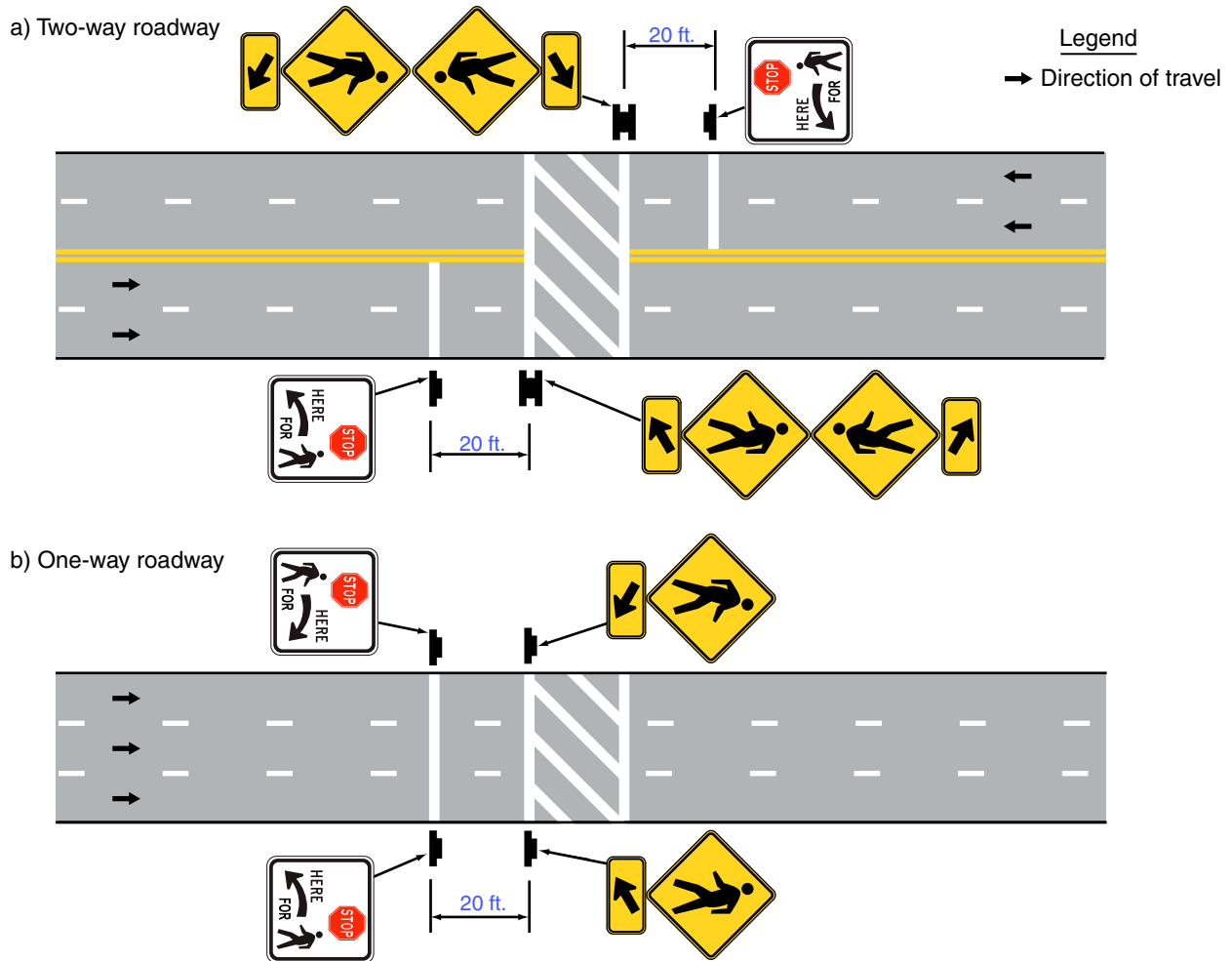

Figure 3B-17. Examples of Stop Lines at Unsignalized Midblock Crosswalks



Section 3B.17 Do Not Block Intersection Markings

Option:

- 01 *Do Not Block Intersection markings may be used to mark the edges of an intersection area that is in close proximity to a signalized intersection, railroad crossing, or other nearby traffic control that might cause vehicles to stop within the intersection and impede other traffic entering the intersection. If authorized by law, Do Not Block Intersection markings with appropriate signs may also be used at other locations.*

Standard:

- 02 **If used, Do Not Block Intersection markings (see Figure 3B-18) shall consist of one of the following alternatives:**
 - A. Wide solid white lines that outline the intersection area that vehicles must not block;**
 - B. Wide solid white lines that outline the intersection area that vehicles must not block and a white word message such as DO NOT BLOCK or KEEP CLEAR;**
 - C. Wide solid white lines that outline the intersection area that vehicles must not block and white cross-hatching within the intersection area; or**
 - D. A white word message, such as DO NOT BLOCK or KEEP CLEAR, within the intersection area that vehicles must not block.**
- 03 **Do Not Block Intersection markings shall be accompanied by one or more DO NOT BLOCK INTERSECTION (DRIVEWAY) (CROSSING) (R10-7) signs (see Section 2B.53), one or more DO NOT STOP ON TRACKS (R8-8) signs (see Section 8B.09), or one or more similar signs.**

Figure 3B-18. Do Not Block Intersection Markings

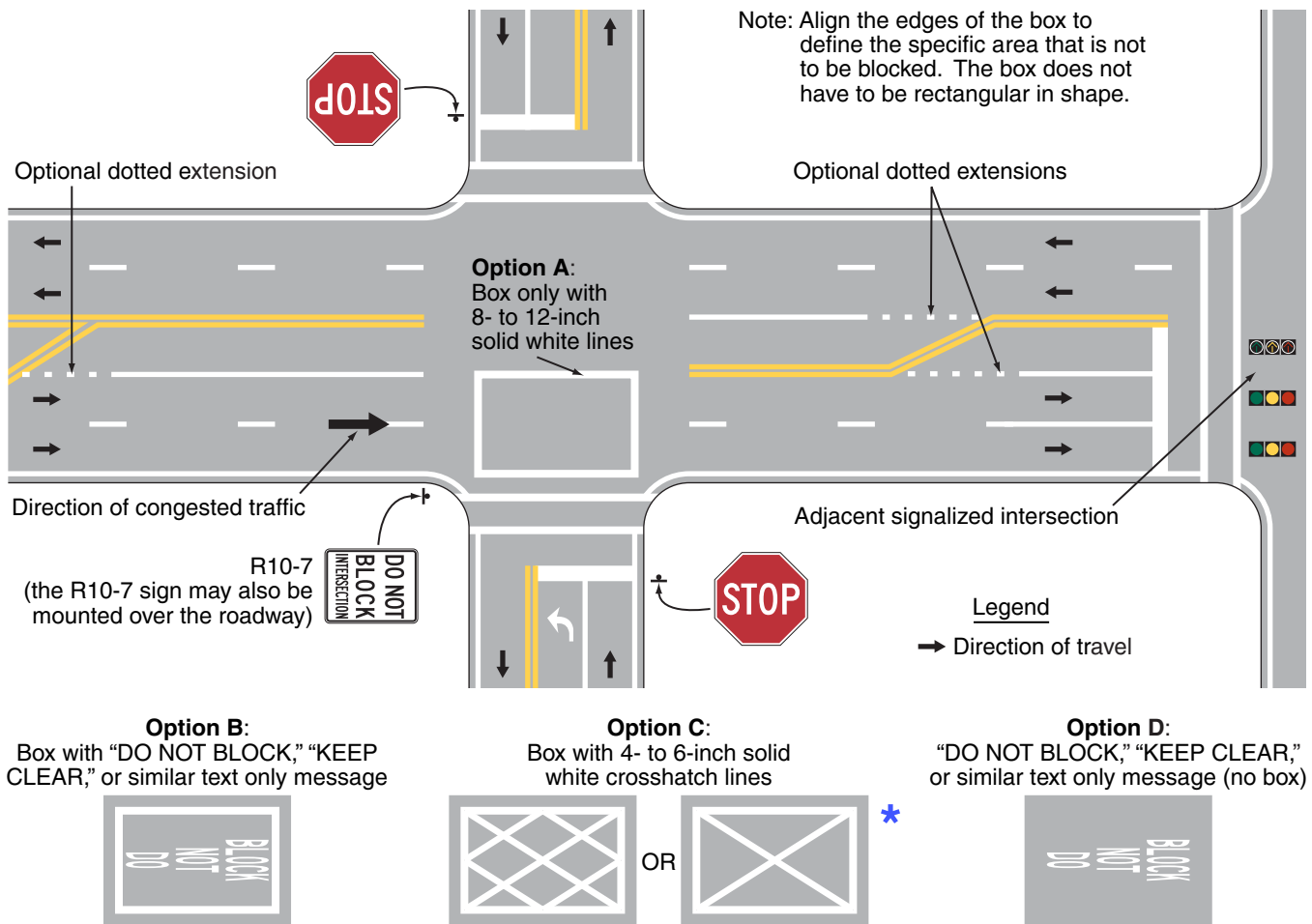

*** For State owned, operated, and maintained intersections, this marking shall be used with 10 inch solid white box lines and 5 inch solid white crosshatch lines.**

Section 3B.18 Crosswalk Markings

Support:

- 01 Crosswalk markings provide guidance for pedestrians who are crossing roadways by defining and delineating paths on approaches to and within signalized intersections, and on approaches to other intersections where traffic stops.
- 02 In conjunction with signs and other measures, crosswalk markings help to alert road users of a designated pedestrian crossing point across roadways at locations that are not controlled by traffic control signals or STOP or YIELD signs.
- 03 At non-intersection locations, crosswalk markings legally establish the crosswalk.

Standard:

- 04 **When crosswalk lines are used, they shall consist of solid white lines that mark the crosswalk. They shall not be less than 6 inches or greater than 24 inches in width.**
- 04a **On State owned, operated, and maintained intersections, crosswalk lines shall be 12 inches wide. Across roadways at non-intersection locations, locations that are unexpected, locations within school zones and across ramps, the space between the crosswalk lines shall be hatched with diagonal white lines that are 12 inches wide.**

Guidance:

- 05 *If transverse lines are used to mark a crosswalk, the gap between the lines should not be less than 6 feet. If diagonal or longitudinal lines are used without transverse lines to mark a crosswalk, the crosswalk should be not less than 6 feet wide.*

07 *At locations controlled by traffic control signals or on approaches controlled by STOP or YIELD signs, crosswalk lines should be installed where engineering judgment indicates they are needed to direct pedestrians to the proper crossing path(s).*

08 *Crosswalk lines should not be used indiscriminately. An engineering study should be performed before a marked crosswalk is installed at a location away from a traffic control signal or an approach controlled by a STOP or YIELD sign. The engineering study should consider the number of lanes, the presence of a median, the distance from adjacent signalized intersections, the pedestrian volumes and delays, the average daily traffic (ADT), the posted or statutory speed limit or 85th-percentile speed, the geometry of the location, the possible consolidation of multiple crossing points, the availability of street lighting, and other appropriate factors.*

09 *New marked crosswalks alone, without other measures designed to reduce traffic speeds, shorten crossing distances, enhance driver awareness of the crossing, and/or provide active warning of pedestrian presence, should not be installed across uncontrolled roadways where the speed limit exceeds 40 mph and either:*

A The roadway has four or more lanes of travel without a raised median or pedestrian refuge island and an ADT of 12,000 vehicles per day or greater; or

B. The roadway has four or more lanes of travel with a raised median or pedestrian refuge island and an ADT of 15,000 vehicles per day or greater.

Guidance:

11 *Because non-intersection pedestrian crossings are generally unexpected by the road user, warning signs (see Section 2C.50) should be installed for all marked crosswalks at non-intersection locations and adequate visibility should be provided by parking prohibitions.*

Support:

12 Section 3B.16 contains information regarding placement of stop line markings near crosswalk markings.

Option:

13 For added visibility, the area of the crosswalk may be marked with white diagonal lines at a 45-degree angle to the line of the crosswalk or with white longitudinal lines parallel to traffic flow as shown in Figure 3B-19.

14 When diagonal or longitudinal lines are used to mark a crosswalk, the transverse crosswalk lines may be omitted. This type of marking may be used at locations where substantial numbers of pedestrians cross without any other traffic control device, at locations where physical conditions are such that added visibility of the crosswalk is desired, or at places where a pedestrian crosswalk might not be expected.

Guidance:

15 *If used, the diagonal or longitudinal lines should be 12 inches wide and separated by gaps of 24 inches. The design of the lines and gaps should avoid the wheel paths if possible, and the gap between the lines should not exceed 2.5 times the width of the diagonal or longitudinal lines.*

Standard:

15a **Crosswalks shall be marked at the following locations:**

- 1. All school crossings (see Part 7 for additional information regarding school crossings);**
- 2. All recreational pedestrian (hiker) and/or bike crossings;**
- 3. All locations having pedestrian crossing warning signs;**
- 4. All pedestrian crossings having pedestrian signal indications;**
- 5. All mid-block/non-intersection locations;**
- 6. Any point where pedestrians crossing would be unexpected.**

Guidance:

15b *Crosswalks should be marked at the following locations:*

- 1. At points toward which pedestrians are directed to cross through special signing, public information and education campaigns, etc.*
- 2. Near major generators of pedestrian activity such as, transit facilities, office parks, stadiums, shopping centers, etc.*
- 3. At intersections having special pedestrian refuge islands/medians.*
- 4. Across ramps and right turn slots.*

15c *Crosswalks should not be marked where there are no supportable/documented reasons to do so, such as:*

- 1. Marked crosswalks have not been shown to provide improved safety over unmarked crosswalks.*
- 2. Marked crosswalks may provide a false sense of security for pedestrians who may use less care at crosswalks that are marked.*

Figure 3B-19. Examples of Crosswalk Markings and Stop Lines
(Sheet 1 of 2)

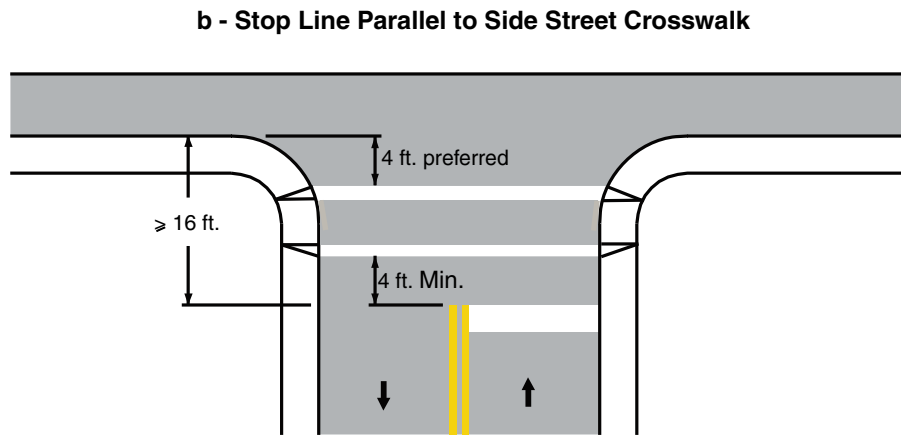
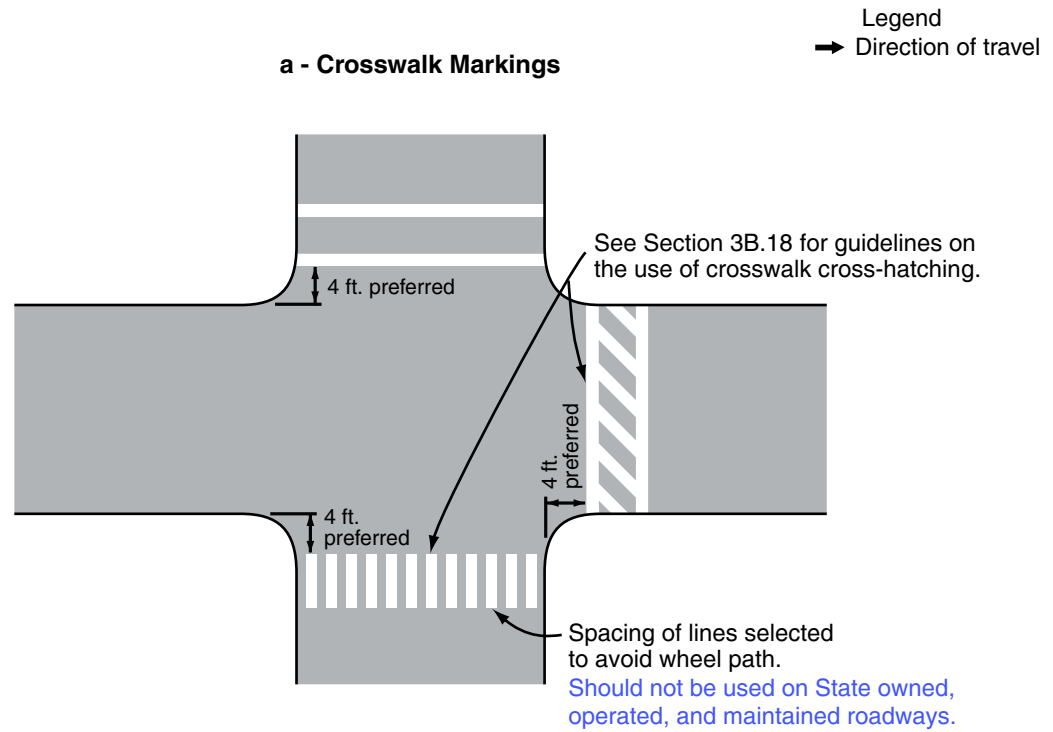

Width of Stop Line:
 - 16 inches, for side street speed limit 35 mph and below.
 - 24 inches, for side street speed limit above 35 mph.

Figure 3B-19. Examples of Crosswalk Markings and Stop Lines
(Sheet 2 of 2)

Legend
→ Direction of travel

c - Stop Line Parallel to Intersecting Roadway

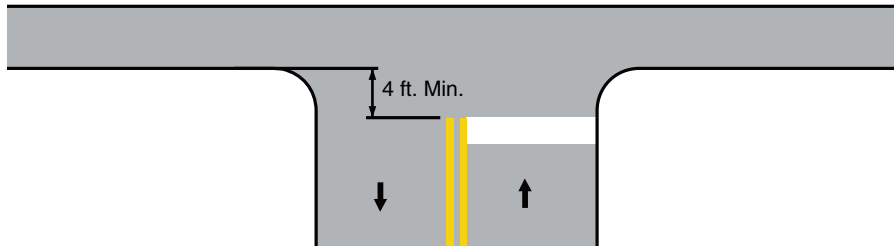

Width of Stop Line:
- 16 inches, for side street speed limit 35 mph and below.
- 24 inches, for side street speed limit above 35 mph.

d - Skewed Intersection

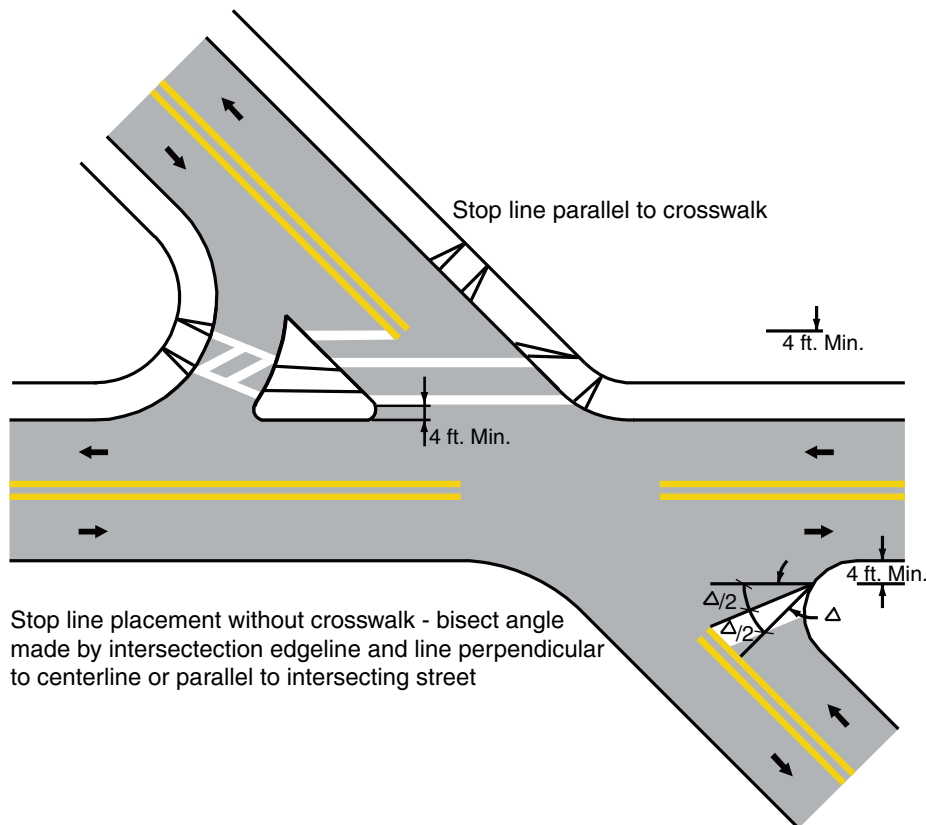
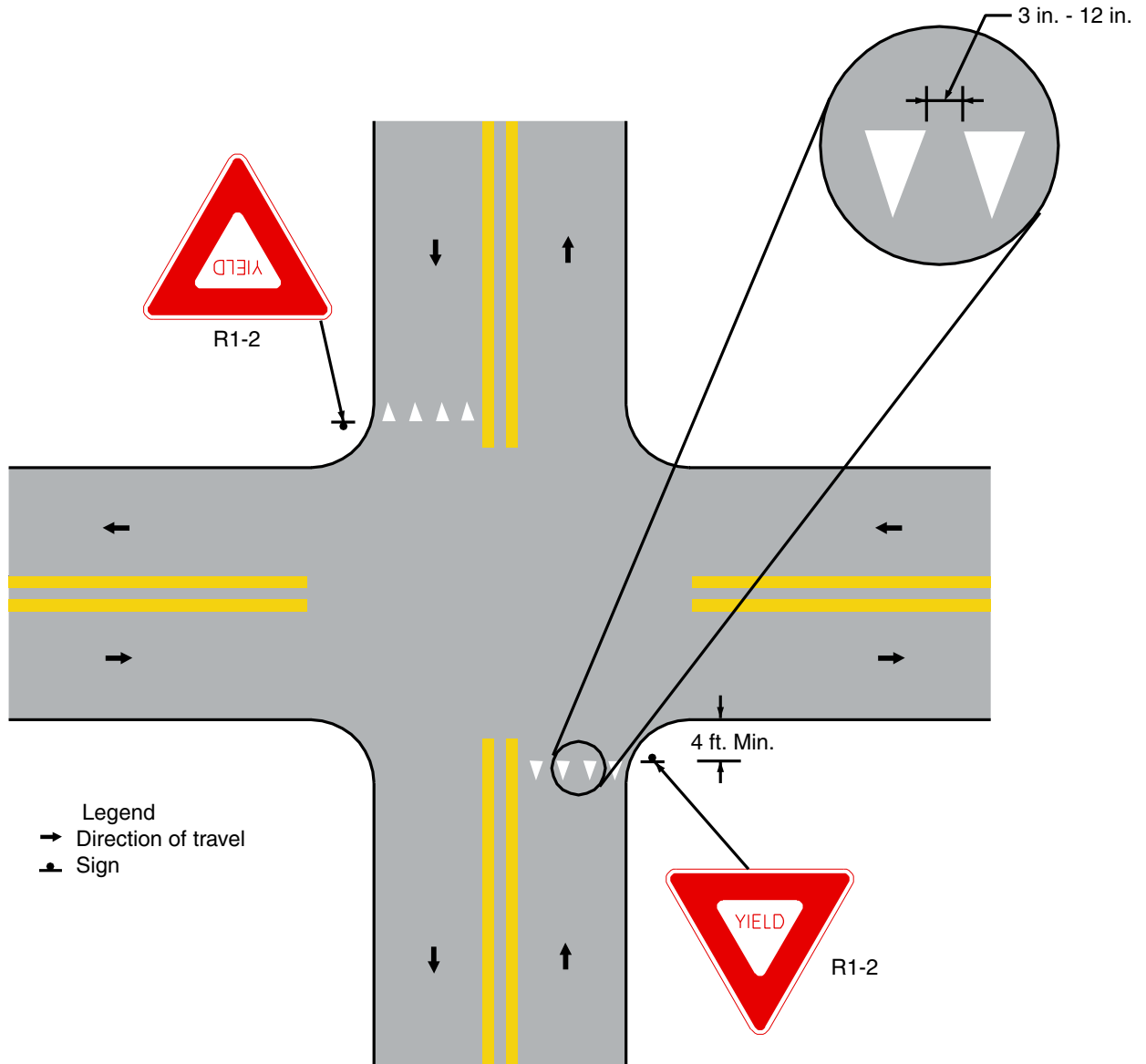
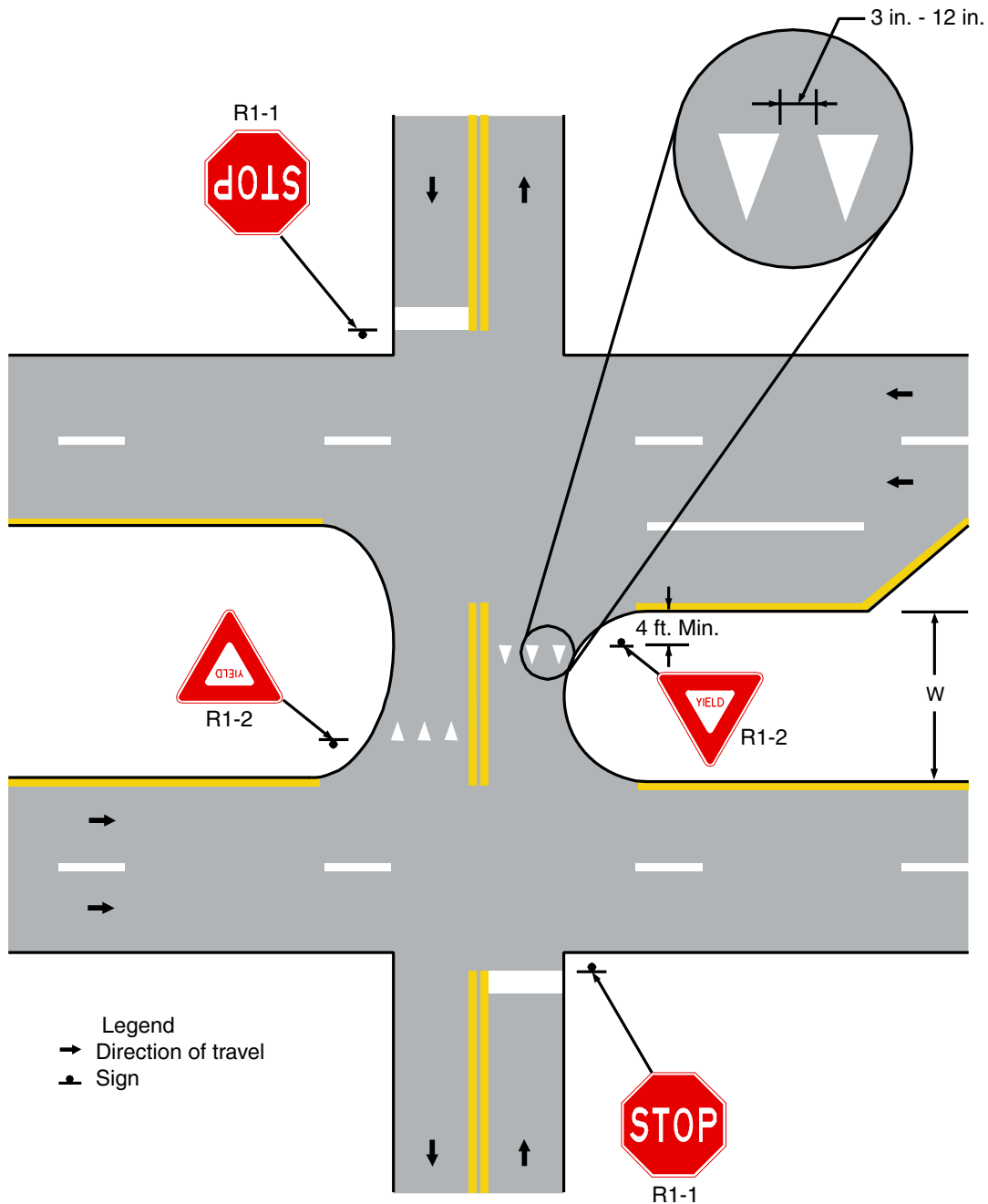

Figure 3B-19a. Examples of Yield or Reference Line as Extension of Edge Line at YIELD Sign Approach to Intersection



- Notes:
- Triangle Length and Base Dimension
 - 18 inches / 12 inches, for side street speed limit 40 mph and below.
 - 36 inches / 24 inches, for side street speed limit above 40 mph.

Figure 3B-19b. Examples of YIELD Sign at Second Roadway of Divided Highway Yield Lines



Notes:

1. The Yield sign placement and location is based on:
 - Width of median opening, $W \geq 50$ feet
 - Turning radius
 - Storage length in median opening
2. Triangle Length and Base Dimension:
 - 18 inches / 12 inches, for side street speed limit 40 mph and below.
 - 36 inches / 24 inches, for side street speed limit above 40 mph
3. Double Yellow Pavement Markings should be placed in the median if $W \geq 50$ feet.

Figure 3B-19c. Examples of Edge Line Extension at Ramp without Merge Area

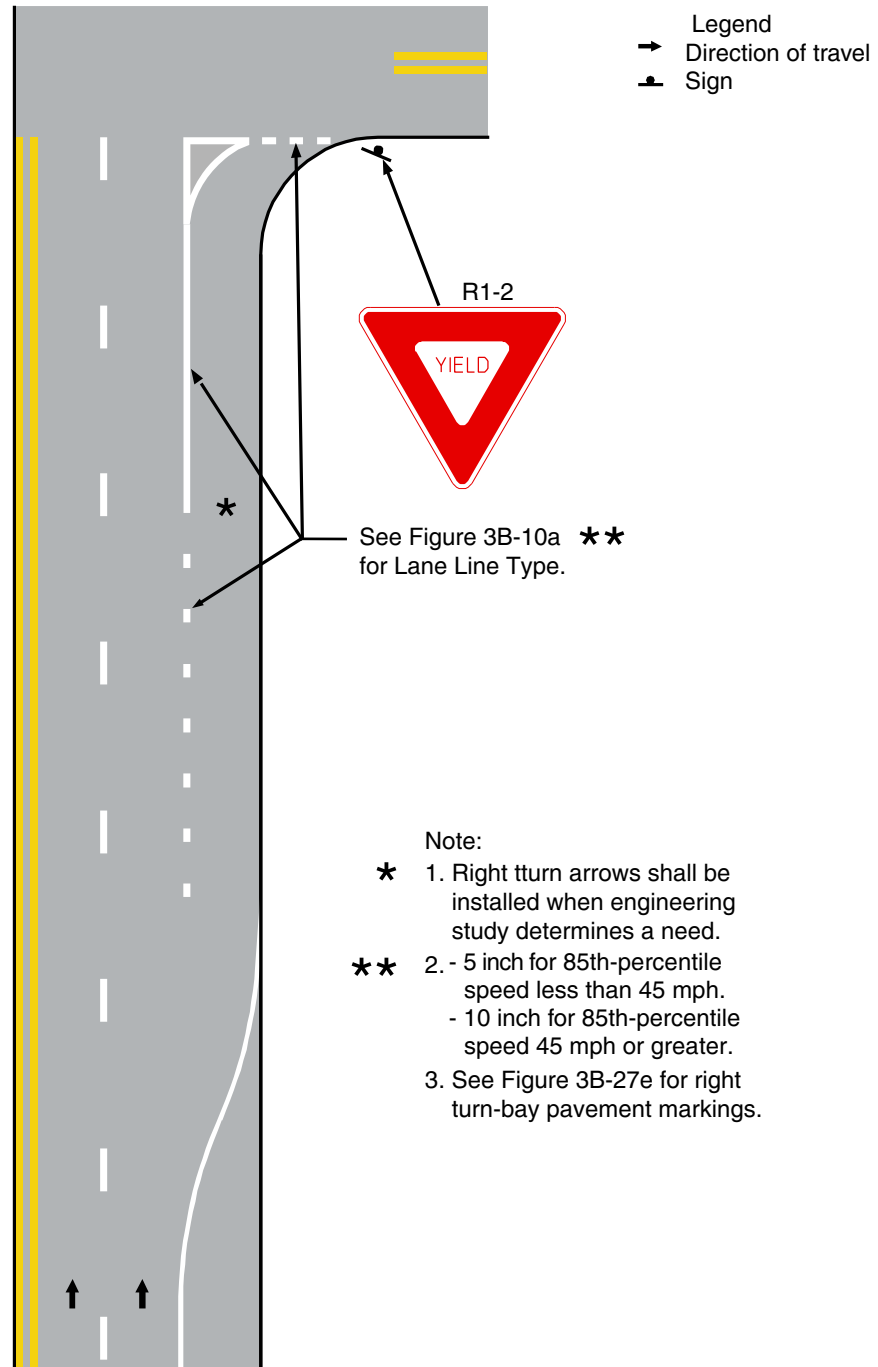
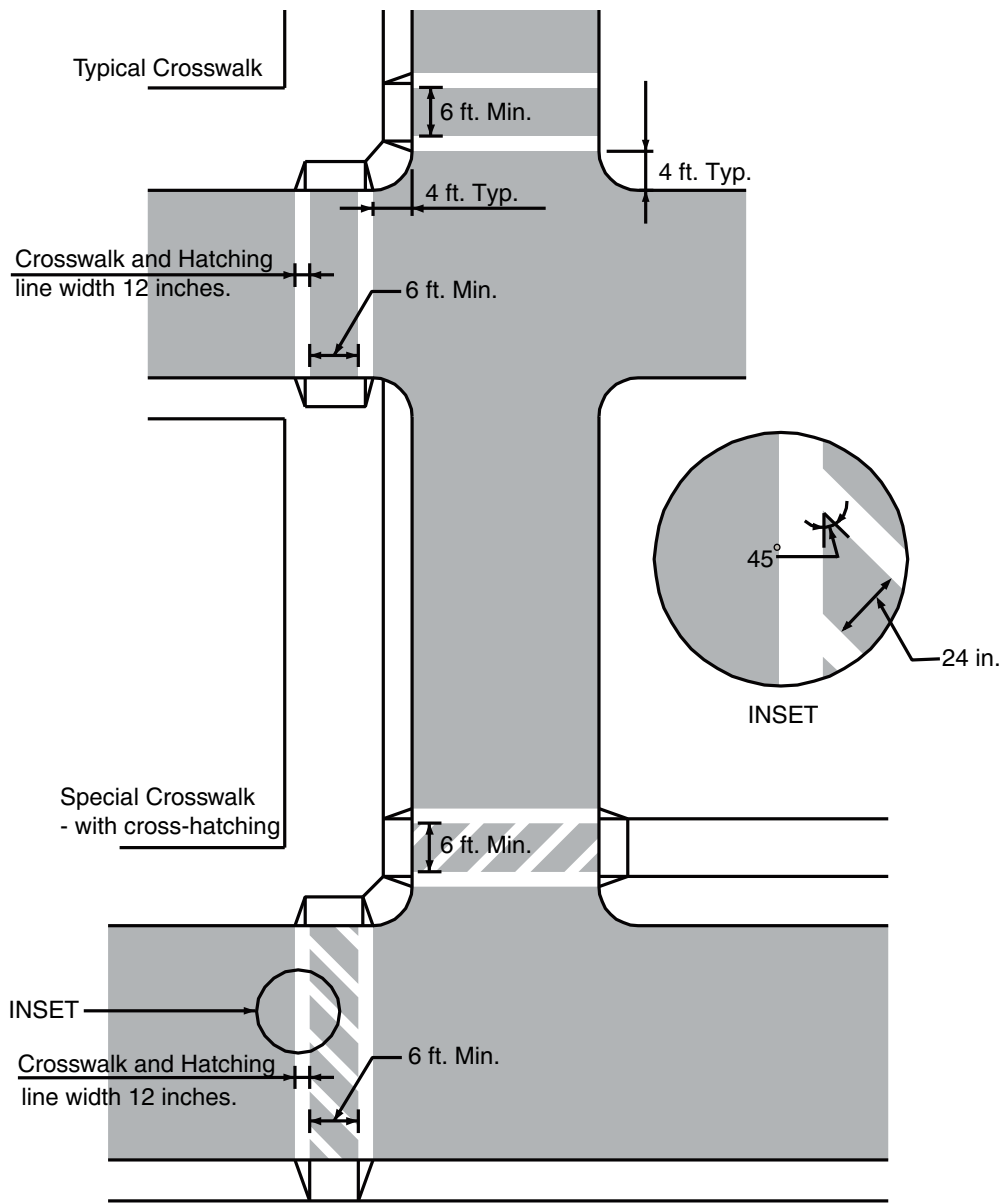

Figure 3B-20. Example of Crosswalk Markings for an Exclusive Pedestrian Phase that Permits Diagonal Crossing

Shall not be used in Maryland.

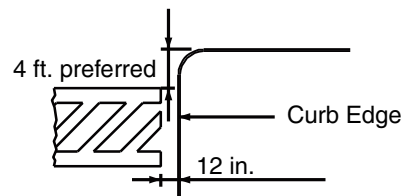

Figure 3B-20a. Examples of Crosswalk and Crosswalk Lines



A crosswalk placed at an intersection is preferred to be placed no closer than 4 feet from the nearest edge of the intersecting roadway.

Across roadways at non-intersection locations, locations that are unexpected, school crossing, and across ramps, crosswalk lines shall be 12 inches wide. The space between the crosswalk lines shall be hatched with diagonal white lines that are 12 inches wide.



When using lane tape material, allow for gutter drainage by starting material 12 inches from the curb edge.

Guidance:

- 17 *Crosswalk markings should be located so that the curb ramps are within the extension of the crosswalk markings.*

Support:

- 18 Detectable warning surfaces mark boundaries between pedestrian and vehicular ways where there is no raised curb. Detectable warning surfaces are required by 49 CFR, Part 37 and by the Americans with Disabilities Act (ADA) where curb ramps are constructed at the junction of sidewalks and the roadway, for marked and unmarked crosswalks. Detectable warning surfaces contrast visually with adjacent walking surfaces, either light-on-dark, or dark-on-light. The “Americans with Disabilities Act Accessibility Guidelines for Buildings and Facilities (ADAAG)” (see Section 1A.11) contains specifications for design and placement of detectable warning surfaces.

Section 3B.19 Parking Space Markings**Support:**

- 01 Marking of parking space boundaries encourages more orderly and efficient use of parking spaces where parking turnover is substantial. Parking space markings tend to prevent encroachment into fire hydrant zones, bus stops, loading zones, approaches to intersections, curb ramps, and clearance spaces for islands and other zones where parking is restricted. Examples of parking space markings are shown in Figure 3B-21.

Standard:

- 02 **Parking space markings shall be white.**

Option:

- 03 Blue lines may supplement white parking space markings of each parking space designated for use only by persons with disabilities.

Support:

- 04 Additional parking space markings for the purpose of designating spaces for use only by persons with disabilities are discussed in Section 3B.20 and illustrated in Figure 3B-22. The design and layout of accessible parking spaces for persons with disabilities is provided in the “Americans with Disabilities Act Accessibility Guidelines (ADAAG)” (see Section 1A.11).

- 04a [For additional information, contact SHA’s Office of Traffic and Safety, Traffic Development and Support Division at the address shown on Page i.](#)

Section 3B.20 Pavement Word, Symbol, and Arrow Markings**Support:**

- 01 Word, symbol, and arrow markings on the pavement are used for the purpose of guiding, warning, or regulating traffic. These pavement markings can be helpful to road users in some locations by supplementing signs and providing additional emphasis for important regulatory, warning, or guidance messages, because the markings do not require diversion of the road user’s attention from the roadway surface. Symbol messages are preferable to word messages. Examples of standard word and arrow pavement markings are shown in Figures 3B-23 and 3B-24.

Option:

- 02 Word, symbol, and arrow markings, including those contained in the “Standard Highway Signs and Markings” book (see Section 1A.11), may be used as determined by engineering judgment to supplement signs and/or to provide additional emphasis for regulatory, warning, or guidance messages. Among the word, symbol, and arrow markings that may be used are the following:

A. Regulatory:

1. STOP
2. YIELD
3. RIGHT (LEFT) TURN ONLY
4. 25 MPH
5. Lane-use and wrong-way arrows
6. Diamond symbol for HOV lanes
7. Other preferential lane word markings

Figure 3B-21. Examples of Parking Space Markings

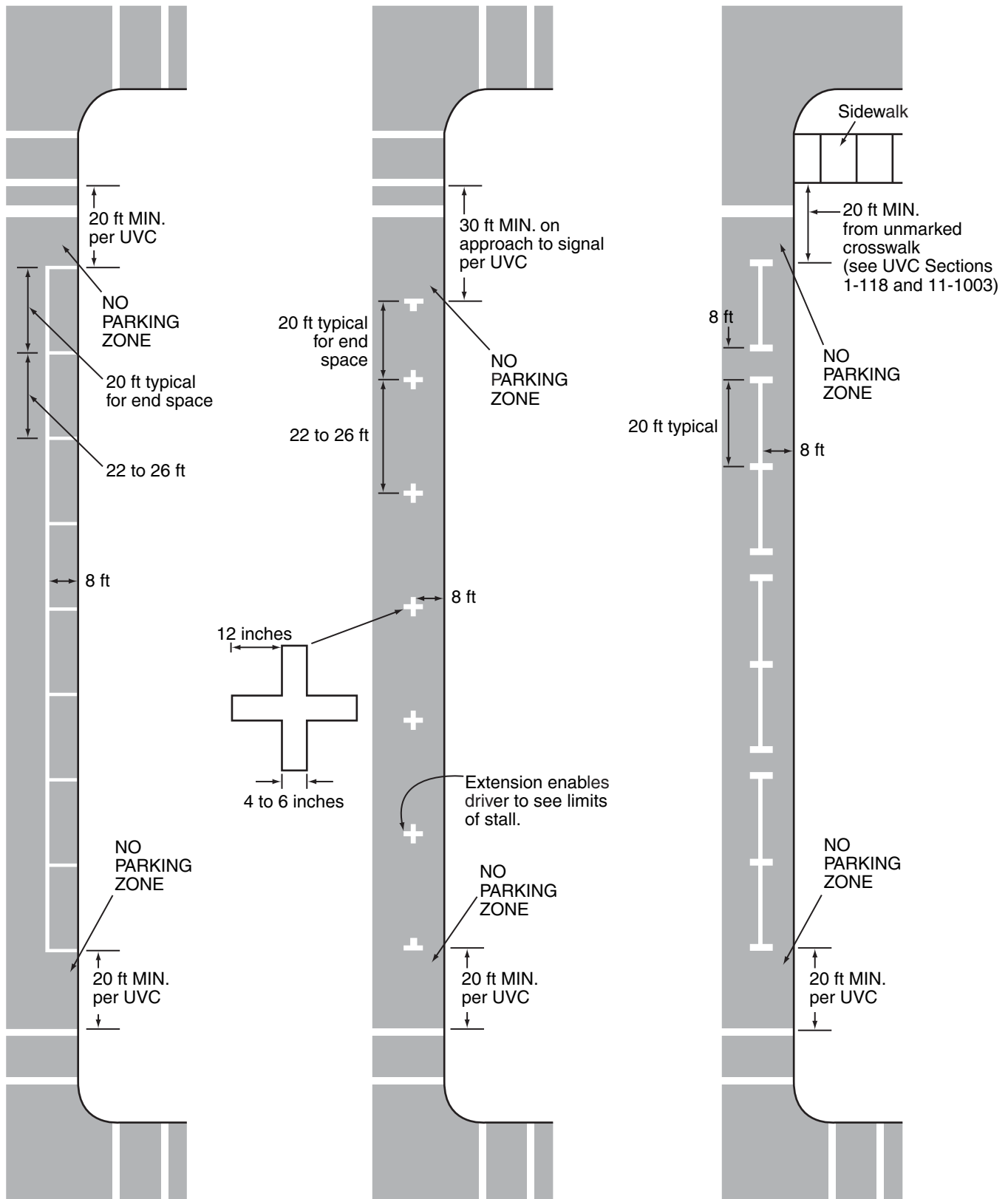

- B. Warning:
 1. STOP AHEAD
 2. YIELD AHEAD
 3. YIELD AHEAD triangle symbol
 4. SCHOOL XING
 5. SIGNAL AHEAD
 6. PED XING
 7. SCHOOL
 8. R X R
 9. BUMP
 10. HUMP
 11. Lane-reduction arrows
- C. Guide:
 1. Route numbers (route shield pavement marking symbols and/or words such as I-81, US 40, STATE 135, or ROUTE 10)
 2. Cardinal directions (NORTH, SOUTH, EAST, or WEST)
 3. TO
 4. Destination names or abbreviations thereof

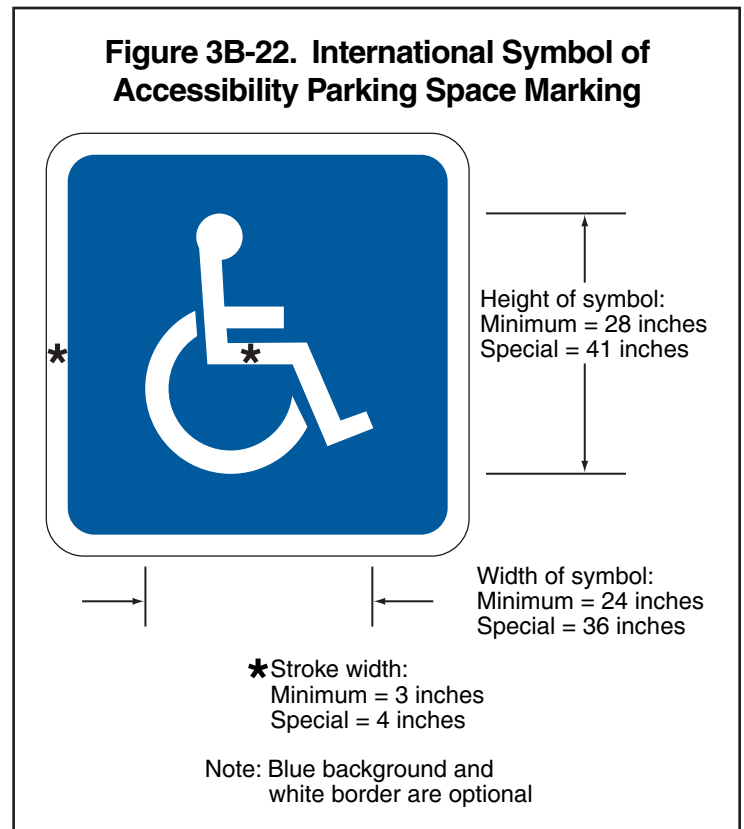
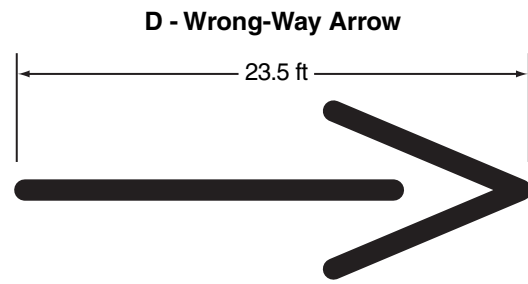
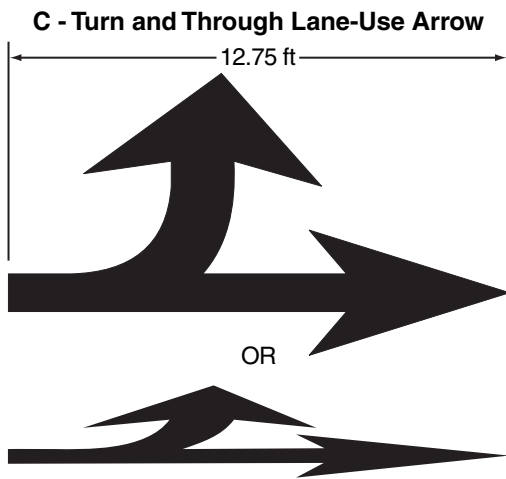
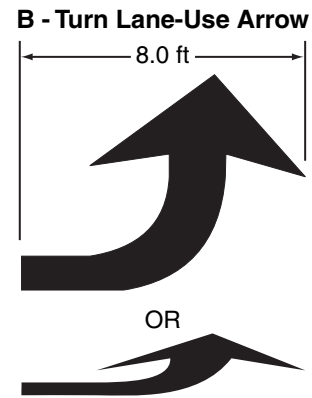
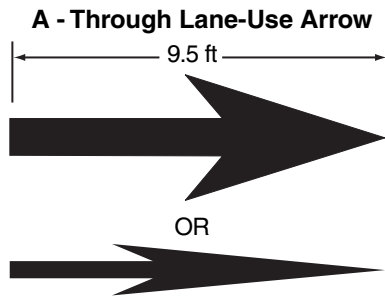

Figure 3B-23. Example of Elongated Letters for Word Pavement Markings



Figure 3B-24. Examples of Standard Arrows for Pavement Markings



E - Wrong-Way Arrow Using Retroreflective Raised Pavement Markers

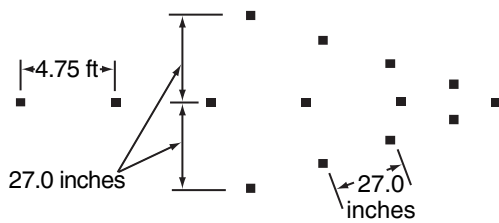

F - Lane-Reduction Arrow

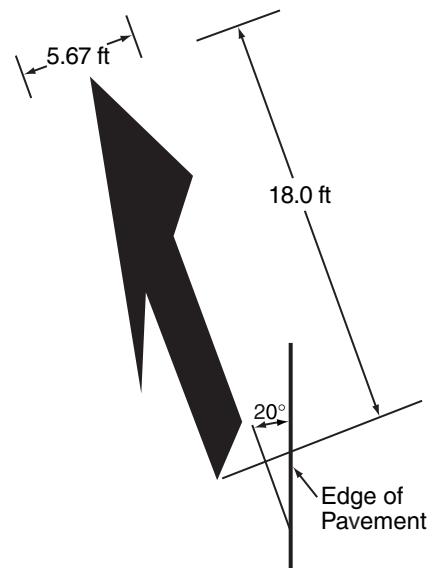

Notes:

1. Typical sizes for normal installation; sizes may be reduced approximately one-third for low-speed urban conditions; larger sizes may be needed for freeways, above average speeds, and other critical locations.
2. The narrow elongated arrow designs shown in Drawings A, B, and C are optional.
3. For proper proportion, see the Pavement Markings chapter of the "Standard Highway Signs and Markings" book (see Section 1A.11).

Standard:

- 03 **Word, symbol, and arrow markings shall be white, except as otherwise provided in this Section.**
 04 **Pavement marking letters, numerals, symbols, and arrows shall be installed in accordance with the design details in the Pavement Markings chapter of the “Standard Highway Signs and Markings” book (see Section 1A.11), and the “Maryland Supplemental Signs” book.**

Guidance:

- 05 *Letters and numerals should be 6 feet or more in height.*
 06 *Word and symbol markings should not exceed three lines of information.*
 07 *If a pavement marking word message consists of more than one line of information, it should read in the direction of travel. The first word of the message should be nearest to the road user.*
 08 *Except for the two opposing arrows of a two-way left-turn lane marking (see Figure 3B-7), the longitudinal space between word or symbol message markings, including arrow markings, should be at least four times the height of the characters for low-speed roads, but not more than ten times the height of the characters under any conditions.*
 09 *The number of different word and symbol markings used should be minimized to provide effective guidance and avoid misunderstanding.*
 10 *Except for the SCHOOL word marking (see Section 7C.03), pavement word, symbol, and arrow markings should be no more than one lane in width.*
 11 *Pavement word, symbol, and arrow markings should be proportionally scaled to fit within the width of the facility upon which they are applied.*

Option:

- 12 On narrow, low-speed shared-use paths, the pavement words, symbols, and arrows may be smaller than suggested, but to the relative scale.
 13 Pavement markings simulating Interstate, U.S., State, and other official highway route shield signs (see Figure 2D-3) with appropriate route numbers, but elongated for proper proportioning when viewed as a marking, may be used to guide road users to their destinations (see Figure 3B-25).

Standard:

- 14 **Except at the ends of aisles in parking lots, the word STOP shall not be used on the pavement unless accompanied by a stop line (see Section 3B.16) and STOP sign (see Section 2B.05). At the ends of aisles in parking lots, the word STOP shall not be used on the pavement unless accompanied by a stop line.**
 15 **The word STOP shall not be placed on the pavement in advance of a stop line, unless every vehicle is required to stop at all times.**

Option:

- 16 A yield-ahead triangle symbol (see Figure 3B-26) or YIELD AHEAD word pavement marking may be used on approaches to intersections where the approaching traffic will encounter a YIELD sign at the intersection.

Standard:

- 17 **The yield-ahead triangle symbol or YIELD AHEAD word pavement marking shall not be used unless a YIELD sign (see Section 2B.08) is in place at the intersection. The yield-ahead symbol marking shall be as shown in Figure 3B-26.**

Guidance:

- 18 *The International Symbol of Accessibility parking space marking (see Figure 3B-22) should be placed in each parking space designated for use by persons with disabilities.*

Option:

- 19 A blue background with white border may supplement the wheelchair symbol as shown in Figure 3B-22.

Support:

- 20 Lane-use arrow markings (see Figure 3B-24) are used to indicate the mandatory or permissible movements in certain lanes (see Figure 3B-27), and in two-way left-turn lanes (see Figure 3B-7).

Figure 3B-25. Examples of Elongated Route Shields for Pavement Markings

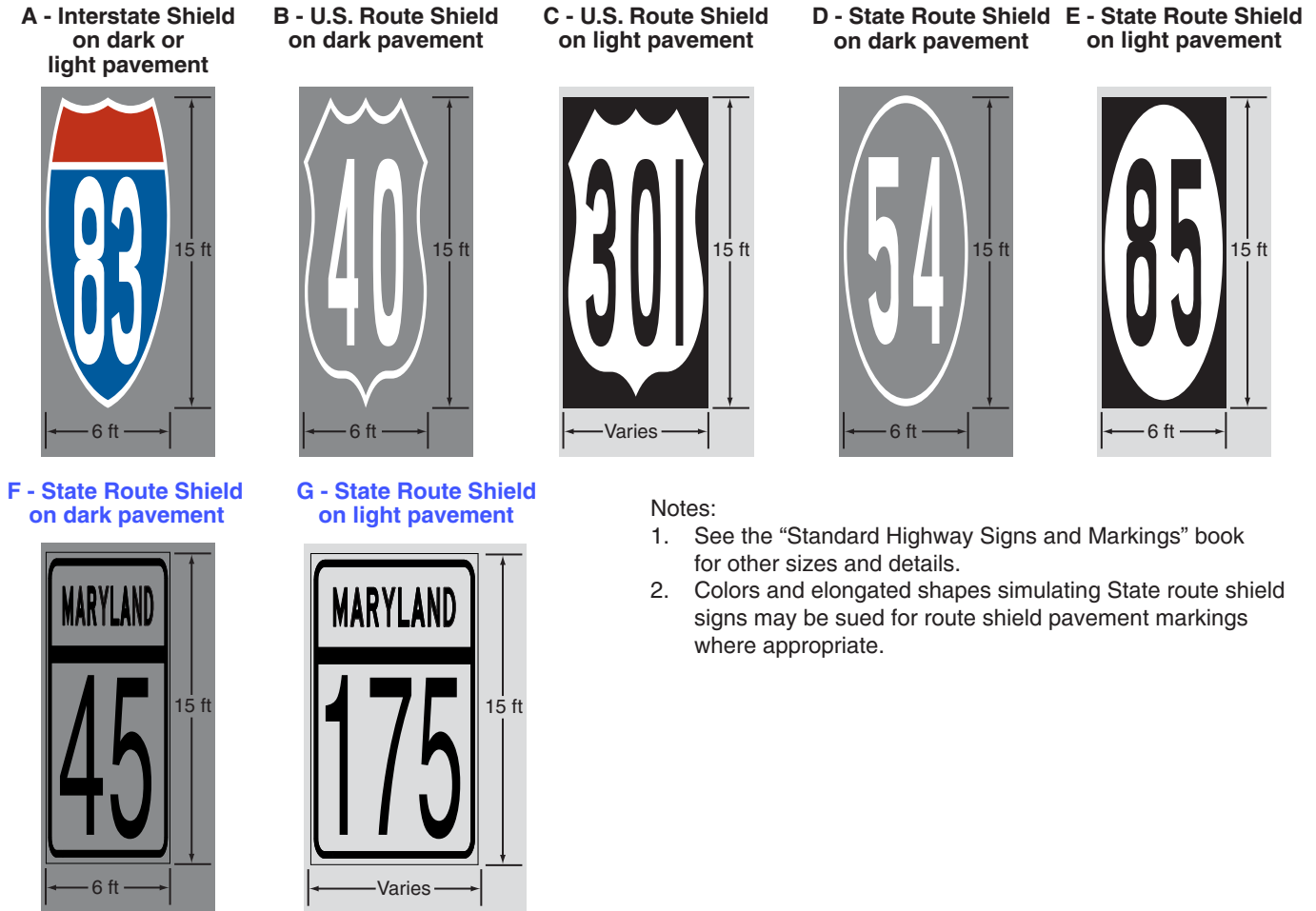

Figure 3B-26. Yield Ahead Triangle Symbols

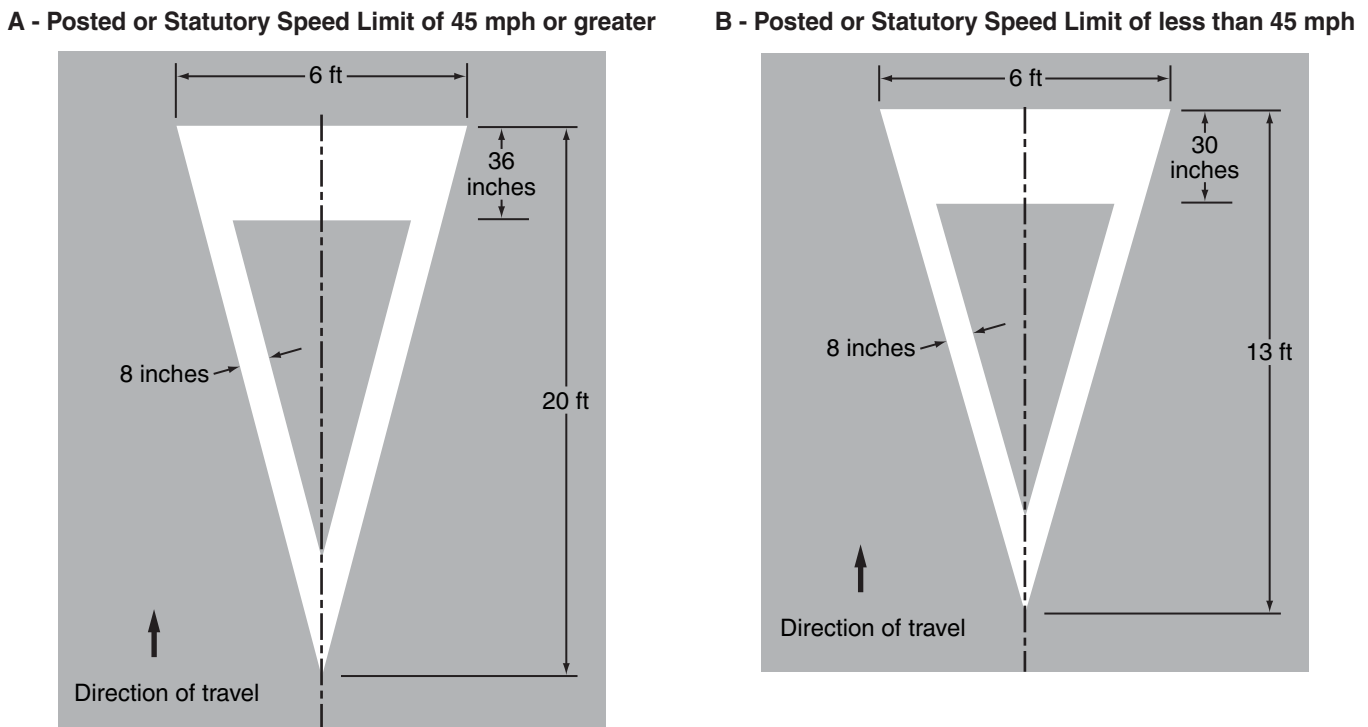

Figure 3B-27. Examples of Lane-Use Control Word and Arrow Pavement Markings

Shall not be used in Maryland.



Guidance:

21 Lane-use arrow markings (see Figure 3B-24) should *not* be used in lanes designated for the exclusive use of a turning movement, including turn bays, except where engineering judgment determines that physical conditions or other markings (such as a dotted extension of the lane line through the taper into the turn bay) *do not* clearly discourage unintentional use of a turn bay by through vehicles. Lane-use arrow markings should also be used in lanes from which movements are allowed that are contrary to the normal rules of the road (see Drawing B of Figure 3B-13). When used in turn lanes, at least two arrows should be used, one at or near the upstream end of the full-width turn lane and one an appropriate distance upstream from the stop line or intersection (see Drawing A of Figure 3B-11).

21a On State owned, operated, and maintained roadways, refer to Figures 3B-27a through 3B-27f for placement of turn arrows.

Option:

22 An additional arrow or arrows may be used in a turn lane. When arrows are used for a short turn lane, the second (downstream) arrow may be omitted based on engineering judgment.

Guidance:

23 Where opposing offset channelized left-turn lanes exist, lane-use arrow markings should be placed near the downstream terminus of the offset left-turn lanes to reduce wrong-way movements (see Figure 2B-17).

Support:

24 An arrow at the downstream end of a turn lane can help to prevent wrong way movements.

Standard:

25 Where through lanes approaching an intersection become mandatory turn lanes, lane-use arrow markings (see Figure 3B-24) shall be used and shall be accompanied by standard signs.

25a On State owned, operated, and maintained intersections, when a lane terminates and a mandatory turn is necessary (lane drop), Turn Lane-Use Arrows and "ONLY" word markings shall be used on non-freeways and shall be accompanied by standard signs (See Figure 3B-27a).

25b When an intersection or major driveway is located between the beginning of the lane drop and its terminus, the use of the "ONLY" as described in Paragraph 25a shall be applied beyond the last intersection or major driveway (See Figure 3B-27b).

Guidance:

26 Where through lanes approaching an intersection become mandatory turn lanes, ONLY word markings (see Figure 3B-23) should be used in addition to the required lane-use arrow markings and signs (see Sections 2B.19 and 2B.20). These markings and signs should be placed well in advance of the turn and should be repeated as necessary to prevent entrapment and to help the road user select the appropriate lane in advance of reaching a queue of waiting vehicles (see Drawing A of Figure 3B-11).

Option:

27 On freeways or expressways where a through lane becomes a mandatory exit lane, lane-use arrow markings may be used on the approach to the exit in the dropped lane and in an adjacent optional through-or-exit lane if one exists.

Guidance:

28 A two-way left-turn lane-use arrow pavement marking, with opposing arrows spaced as shown in Figure 3B-7, should be used at or just downstream from the beginning of a two-way left-turn lane.

Option:

29 Additional two-way left-turn lane-use arrow markings may be used at other locations along a two-way left-turn lane where engineering judgment determines that such additional markings are needed to emphasize the proper use of the lane.

Standard:

30 A single-direction lane-use arrow shall not be used in a lane bordered on both sides by yellow two-way left-turn lane longitudinal markings.

31 Lane-use, lane-reduction, and wrong-way arrow markings shall be designed as shown in Figure 3B-24 and in the "Standard Highway Signs and Markings" book (see Section 1A.11).

Option:

- 32 The ONLY word marking (see Figure 3B-23) may be used to supplement the lane-use arrow markings in lanes that are designated for the exclusive use of a single movement (see Figure 3B-27) or to supplement a preferential lane word or symbol marking (see Section 3D.01).

Standard:

- 33 **The ONLY word marking shall not be used in a lane that is shared by more than one movement.**

Guidance:

- 34 *Where a lane-reduction transition occurs on a roadway with a speed limit of 45 mph or more, the lane-reduction arrow markings shown in Drawing F in Figure 3B-24 should be used (see Figure 3B-14). Except for acceleration lanes, where a lane-reduction transition occurs on a roadway with a speed limit of less than 45 mph, the lane-reduction arrow markings shown in Drawing F in Figure 3B-24 should be used if determined to be appropriate based on engineering judgment.*

Standard:

- 34a **The minimum marking configuration for lane drops shall be arrow-ONLY-arrow with an equal distance of 40 feet to 80 feet between each segment; i.e., from the center of the word ONLY to the center of each arrow (See the illustrations in Figures 3B-27a, and 3B-27b). The last arrow nearest the intersection shall be approximately 50 feet from the intersection, which places the first arrow 130 feet to 210 feet from the intersection.**

Guidance:

- 34b *Usually, the minimum marking is not sufficient to allow motorist in a lane drop to select the appropriate approach lane. Approach speeds (prevailing, not posted speed) are a critical factor.*

Standard:

- 34c **At signalized intersections, the length of the queued vehicles is another critical factor. Whichever factor calls for the longest set of markings shall apply.**

- 34d **When it is appropriate to place the first arrow 210 feet to 370 feet from the intersection, an arrow-ONLY-arrow-ONLY-arrow configuration shall be used, again with an equal distance of 40 feet to 80 feet for each segment, and with the arrow nearest the intersection approximately 50 feet from the intersection.**

- 34e **When a still greater distance is desirable between the first arrow and the intersection, an arrow-ONLY-arrow shall be placed nearest the intersection, as with the minimum marking described above. There shall be an equal distance of 40 feet to 80 feet between each segment, and the arrow nearest the intersection shall be approximately 50 feet from the intersection. That configuration shall be preceded by one or more similar configurations of arrow-ONLY-arrow, and there shall be a distance of 210 feet to 370 feet between each such three-segment configuration.**

Guidance:

- 34f *Two, three-segment configurations, with 200 feet to 400 feet between each would place the first arrow 410 feet to 770 feet from the intersection. Three such three-segment configurations would place the first arrow 690 feet to 1330 feet from the intersection.*

Standard:

- 34g **For lane drop, the standard broken lane line shall become a dotted line beginning at the first approach arrow, and shall become a solid line after passing one-half of the distance from that arrow to the intersection (See the illustrations in Figures 3B-27a, and 3B-27b).**

- 34h **Except as otherwise provided for freeways, R3 Series signs shall also be used (See Sections 2B.19 and 2B.20). When ground mounted signs such as the R3-7 or R3-8 are used, the first sign shall be installed at approximately the location of the first approach arrow, and a second sign shall be installed at the last arrow. If an intermediate street falls between any such sign and the actual turn, "at street", "at route number", or "at signal" shall be added to the sign message.**

Standard:

- 34i **Double Turn Lanes shall be marked with standard turn arrows. A set of turn arrows shall be placed one-half the length of the turn lane from the intersection (See Figure 3B-27c).**

Guidance:

- 34j *When mandatory thru lanes are marked, they should be marked consistent with the principles set forth above for lane drops.*

Option:

- 34k **Mandatory through lanes may be marked to discourage illegal turning.**

Standard:

- 34l **Authorizing optional movements beyond what would otherwise be legally available requires the use of arrows with multiple arrowheads. The word "ONLY" shall not be used.**

Guidance:

- 34m *When adjacent to mandatory/optional turn or thru lanes, the arrows should be lined up opposite the arrows in those lanes.*

Standard:

- 34n **The minimum marking configuration for double turn lanes shall be a lane-use arrow placed a maximum 50 feet from the beginning of the full width turn lane when the length of full width turn lane (L) is no more than 200 feet. A 5 inch white solid line shall be placed between the through lane and the turn lane from the intersection to 1/2 of the taper length of the full width turn lane. A standard broken lane line shall be placed between the turn lanes if necessary.**

Guidance:

- 34o *When the length of full width turn lane is more than 200 feet, it is typical to place the second arrow at half of the length from the intersection to the lane-use arrow placed 50 feet from the beginning of the full width turn lane (See the illustrations in Figure 3B-27c).*

Standard:

- 34p **For exclusive double left turns, a dotted line shall be placed starting at 1/2 of the taper length of the full width turn lane, and shall become a solid line after passing the second lane-use arrow (See Figure 3B-27c). A standard broken lane line shall be placed between the turn lanes.**
- 34q **When a shared lane exists, a standard broken lane line shall be placed between the shared lane and the through lane. The pavement markings between the shared lane and the turn lane typically start with a dotted line from the beginning of full width turn lane and become a solid line after passing one-half of the distance to the intersection from the first lane-use arrow (See Figure 3B-27c).**
- 34r **When a lane-drop is included, see Figures 3B-27c for details.**

Guidance:

- 34s *Special guidelines for exclusive left turn segments inserted within a two-way left turn lane system are contained in Section 3B.03.*

Option:

- 35 Lane-reduction arrow markings may be used in long acceleration lanes based on engineering judgment.

Guidance:

- 36 *Where crossroad channelization or ramp geometrics do not make wrong-way movements difficult, the appropriate lane-use arrow should be placed in each lane of an exit ramp near the crossroad terminal where it will be clearly visible to a potential wrong-way road user (see Figure 2B-18 and 3B-27g).*

Option:

- 37 The wrong-way arrow markings shown in Drawing D in Figure 3B-24 may be placed near the downstream terminus of a ramp as shown in Figures 2B-18 and 2B-19, or at other locations where lane-use arrows are not appropriate, to indicate the correct direction of traffic flow and to discourage drivers from traveling in the wrong direction.

Section 3B.21 Speed Measurement Markings**Support:**

- 01 A speed measurement marking is a transverse marking placed on the roadway to assist the enforcement of speed regulations.

Standard:

- 02 **Speed measurement markings, if used, shall be white, and shall not be greater than 24 inches in width.**

Option:

- 03 Speed measurement markings may extend 24 inches on either side of the center line or 24 inches on either side of edge line markings at 1/4-mile intervals over a 1-mile length of roadway. When paved shoulders of sufficient width are available, the speed measurement markings may be placed entirely on these shoulders (see Drawing A of Figure 3B-10). Advisory signs may be used in conjunction with these markings.

Section 3B.22 Speed Reduction Markings**Support:**

- 01 Speed reduction markings (see Figure 3B-28) are transverse markings that are placed on the roadway within a lane (along both edges of the lane) in a pattern of progressively reduced spacing to give drivers the impression that their speed is increasing. These markings might be placed in advance of an unexpectedly severe horizontal or vertical curve or other roadway feature where drivers need to decelerate prior to reaching the feature and where the desired reduction in speeds has not been achieved by the installation of warning signs and/or other traffic control devices.

Figure 3B-27a. Examples of Lane Drops

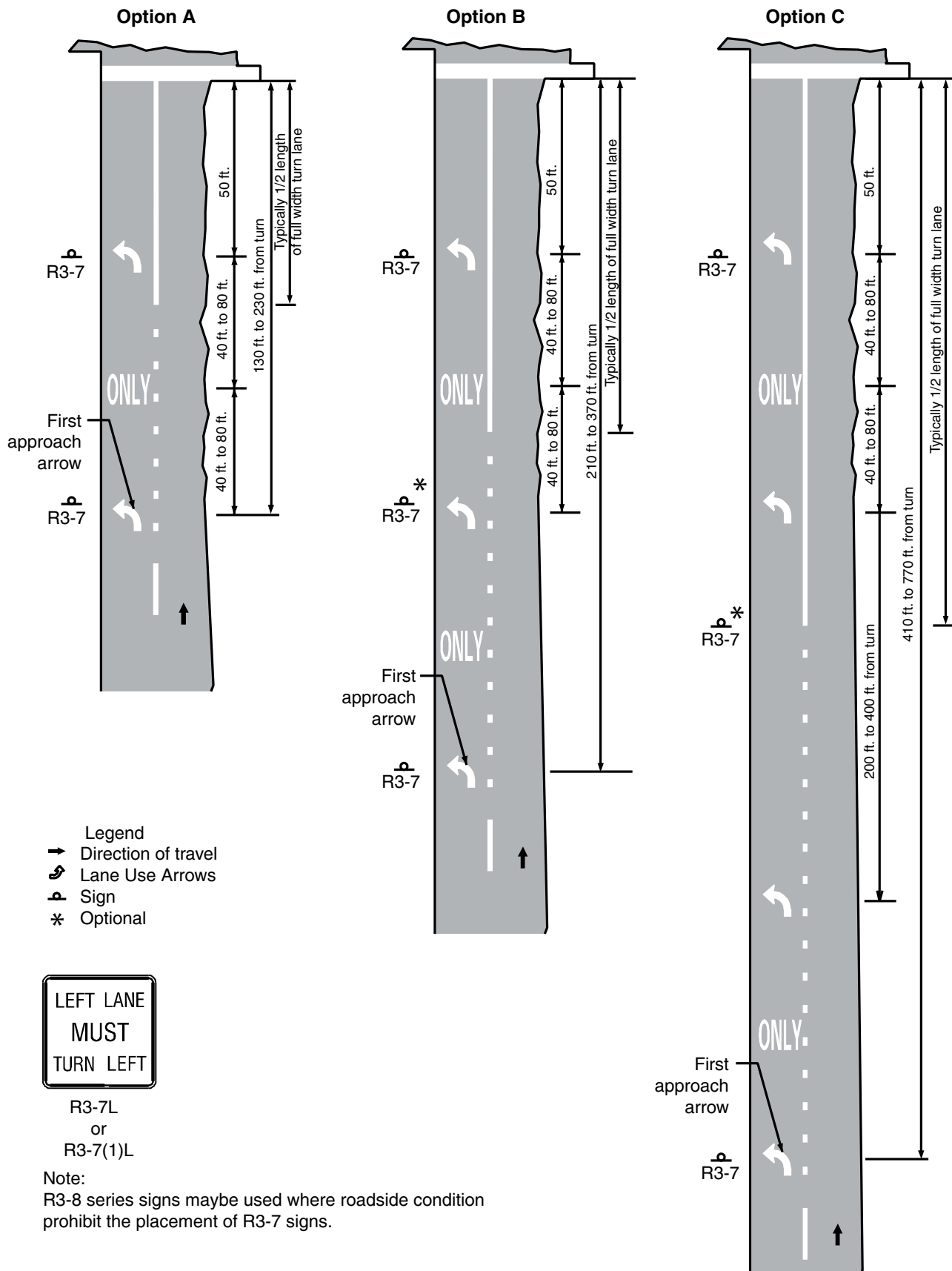

Figure 3B-27b. Examples of Auxiliary Lane Lines Lane Drop - Arterial Application
(Sheet 1 of 2)

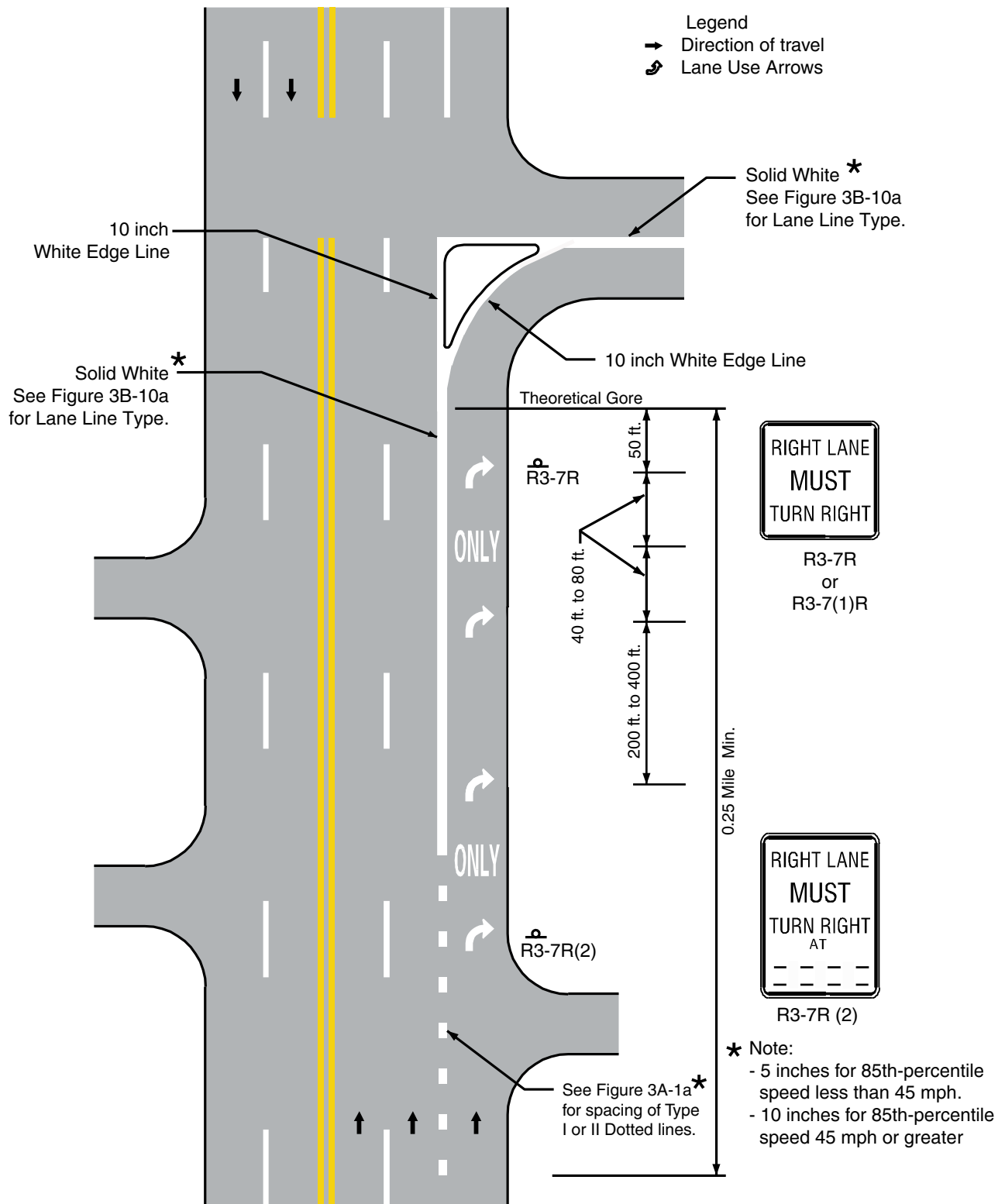

Figure 3B-27b. Examples of Auxiliary Lane Lines Lane Drop - Arterial Application
(Sheet 2 of 2)

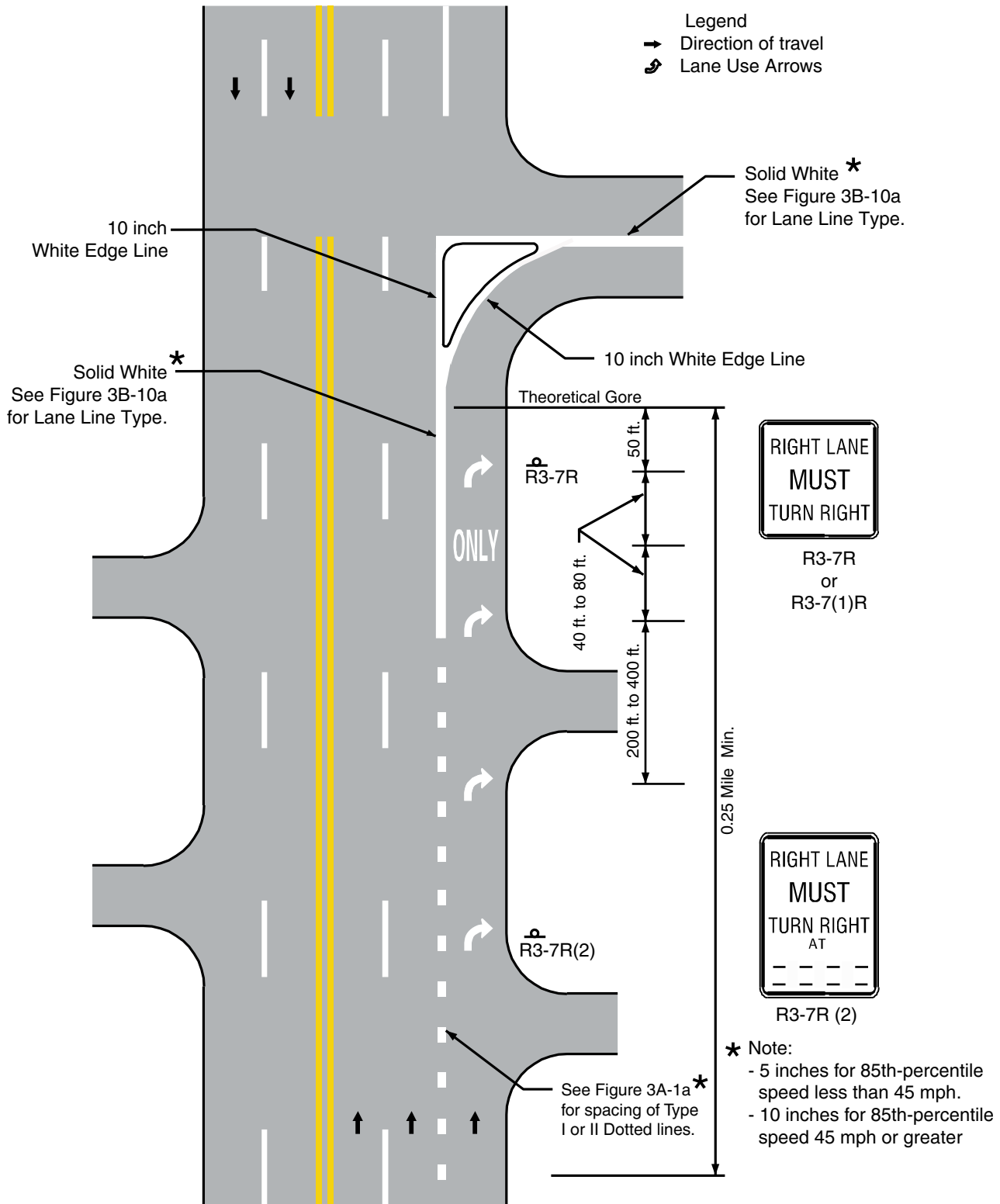

Figure 3B-27c. Examples of Double Left Turn Lane

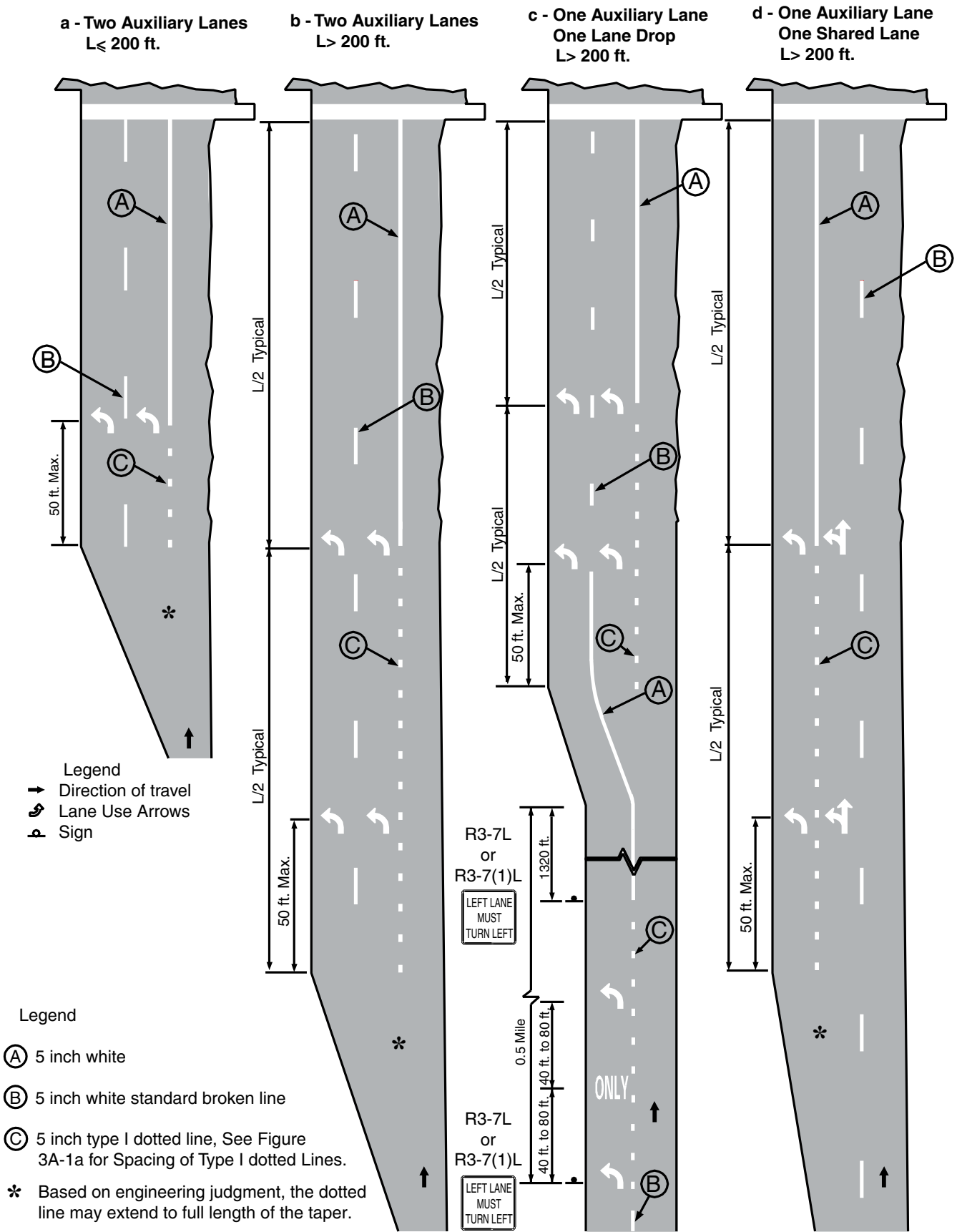

Figure 3B-27d. Examples of Double Right Turn Lane

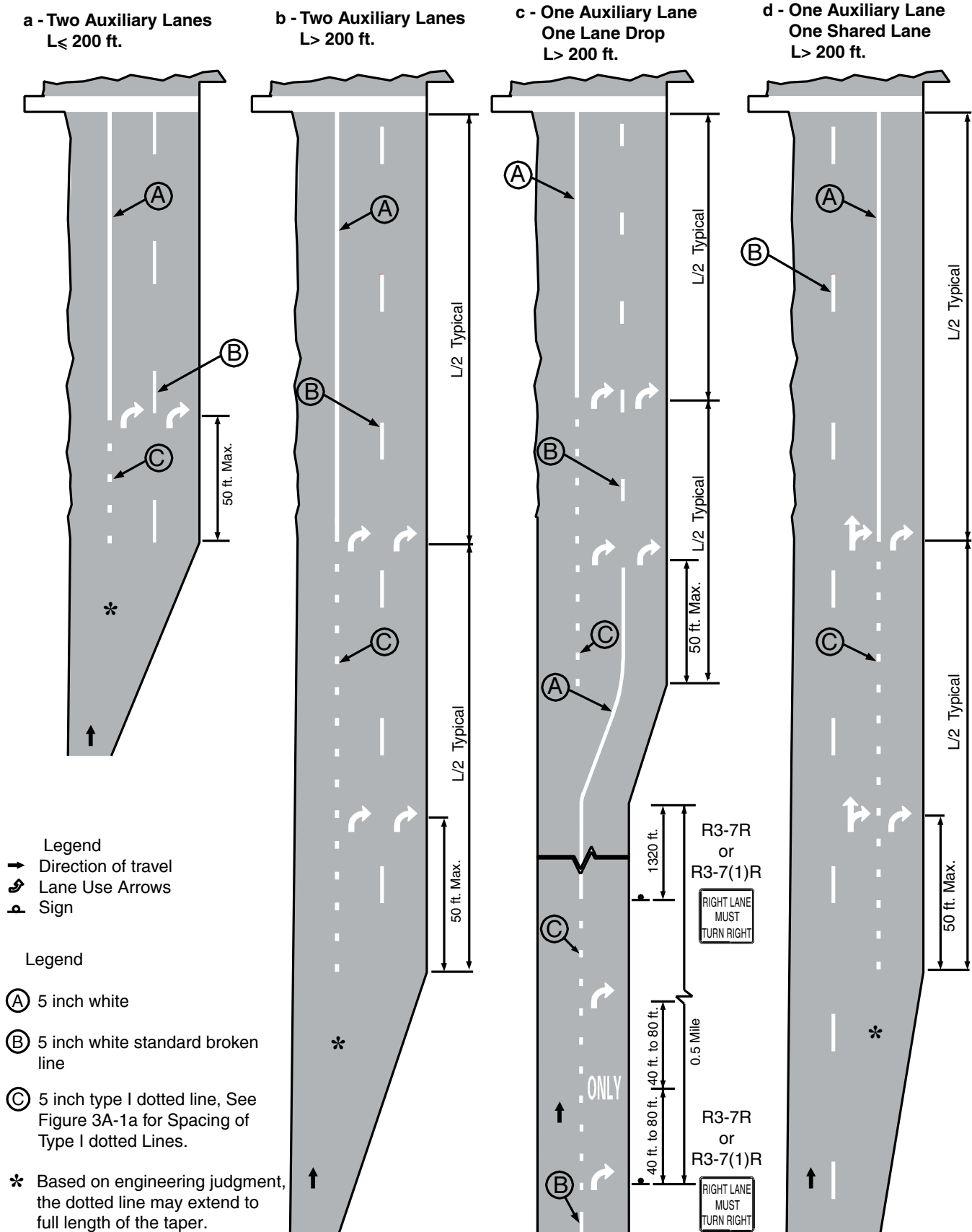

Figure 3B-27e. Examples of Right Turn Bay
- Length of Full Width Turn Lane Not Less Than 200 feet

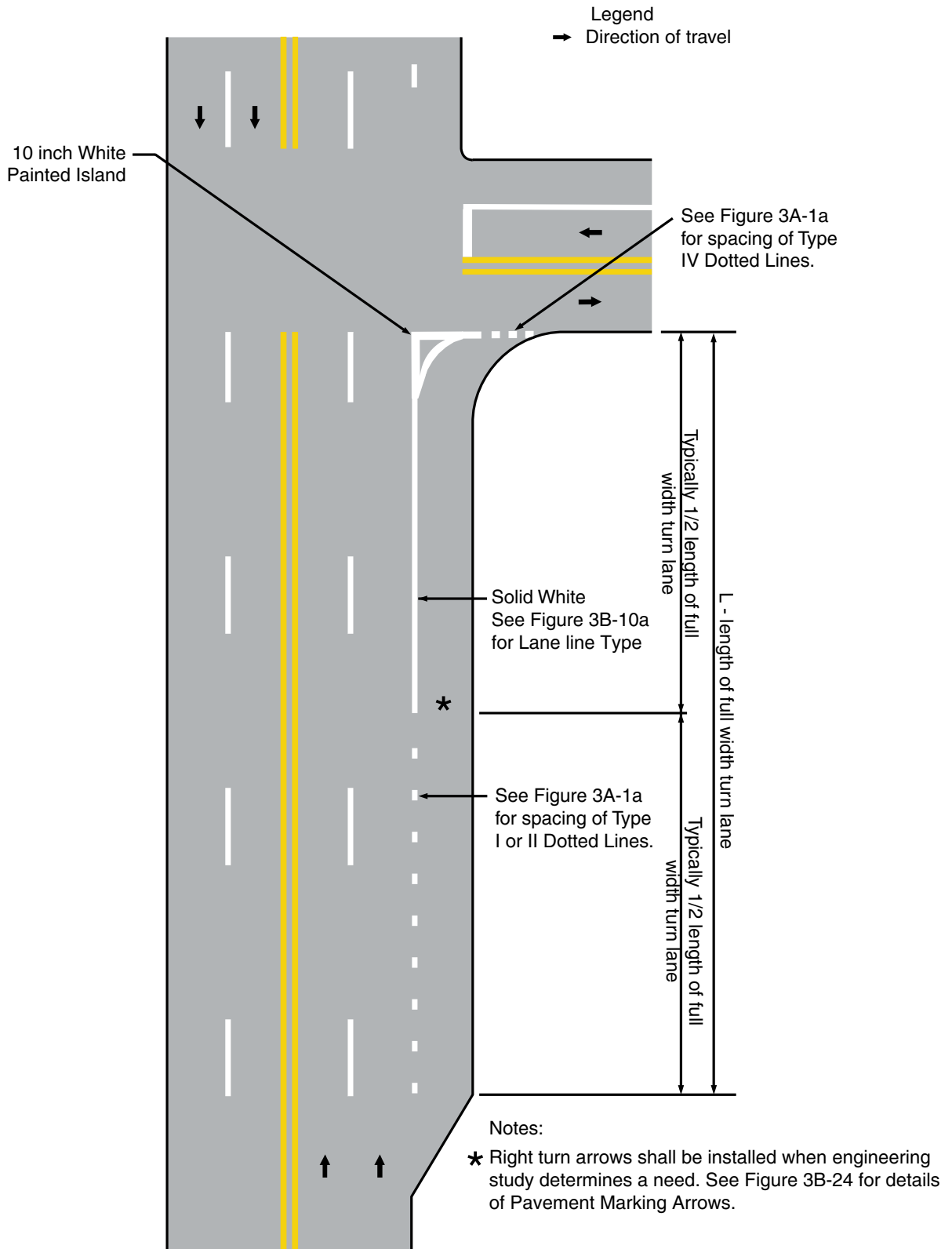

Figure 3B-27f. Examples of Left Turn Bay

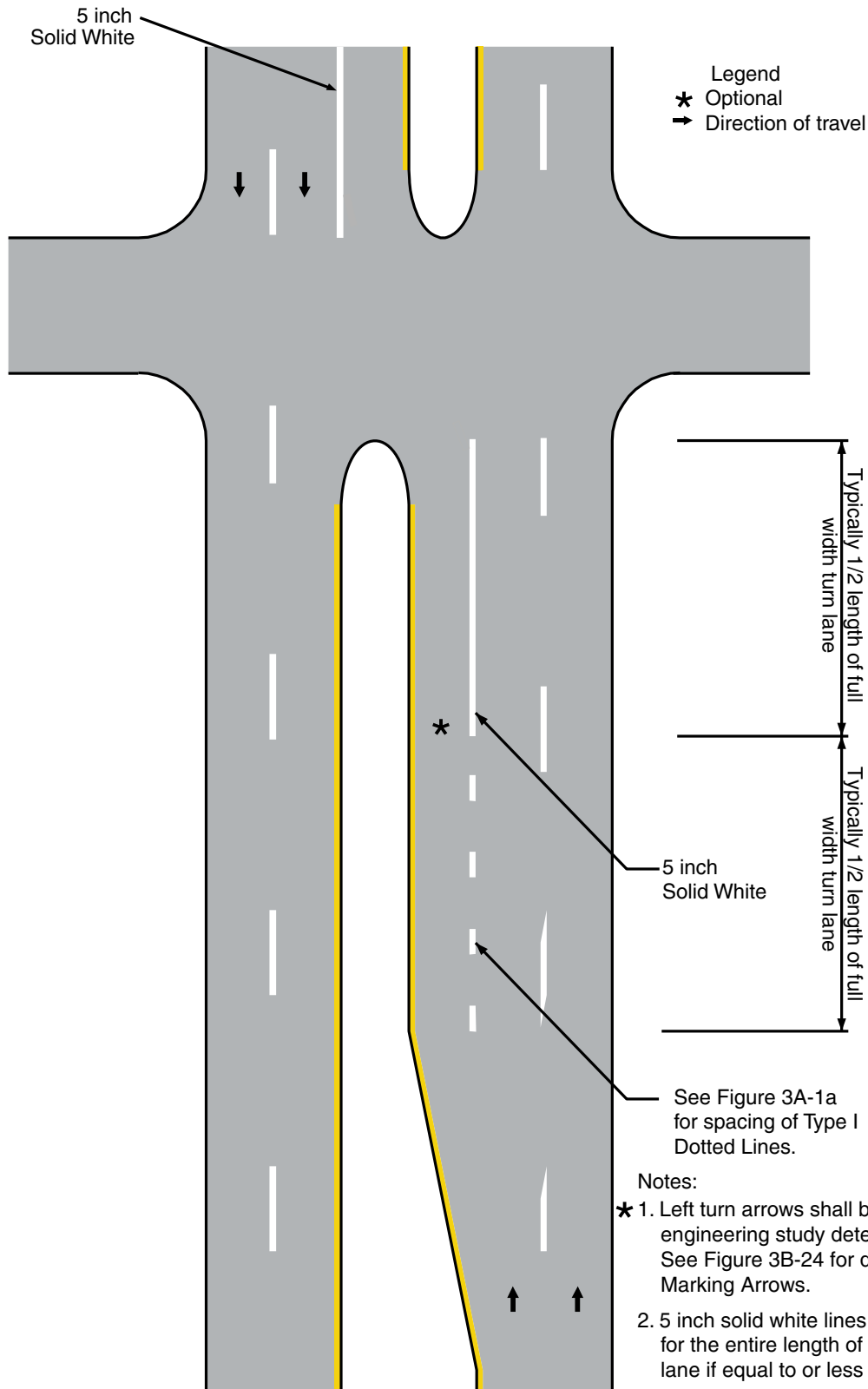

Figure 3B-27g. Examples of Wrong-Way Arrows for Pavement Markings

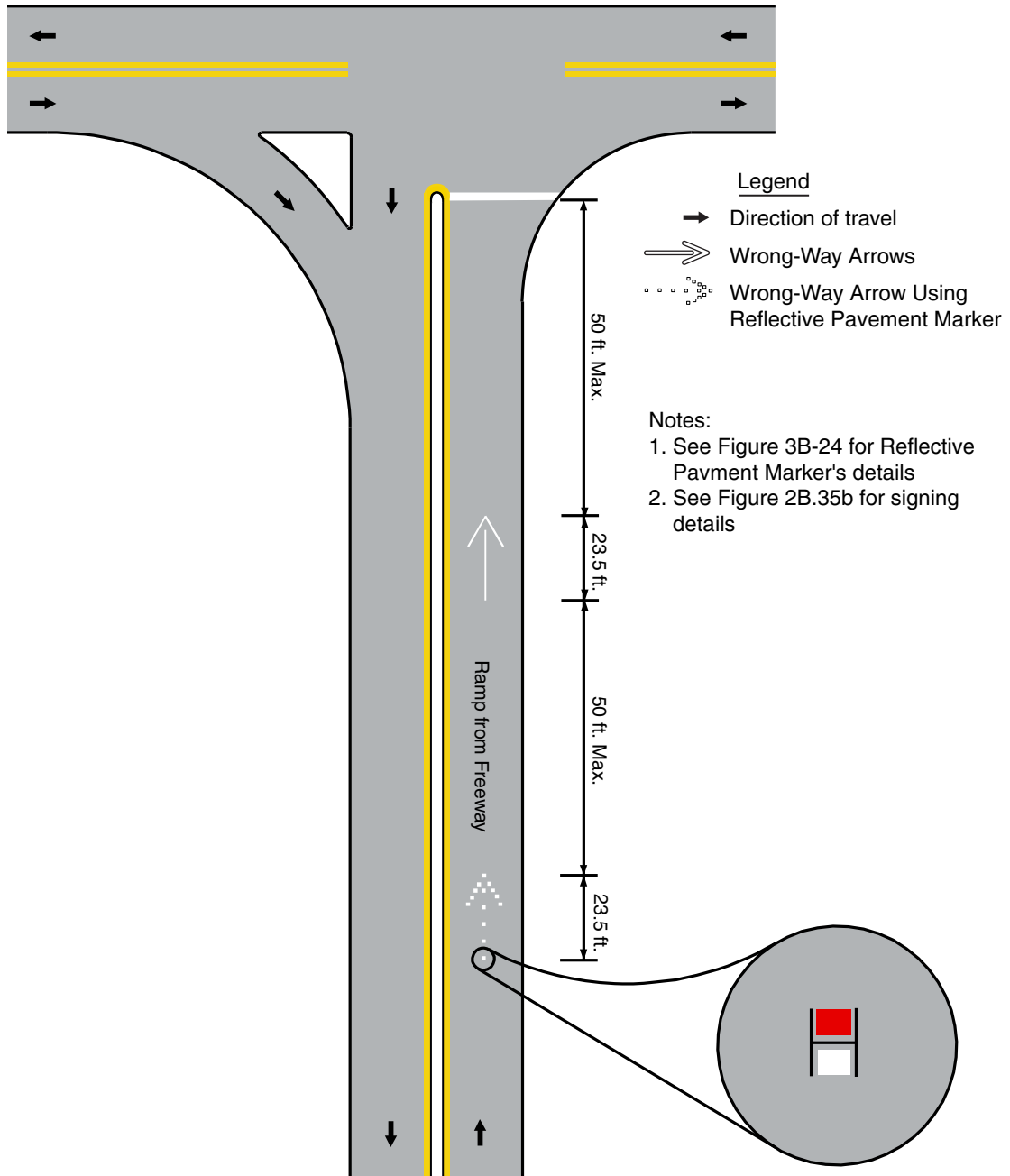
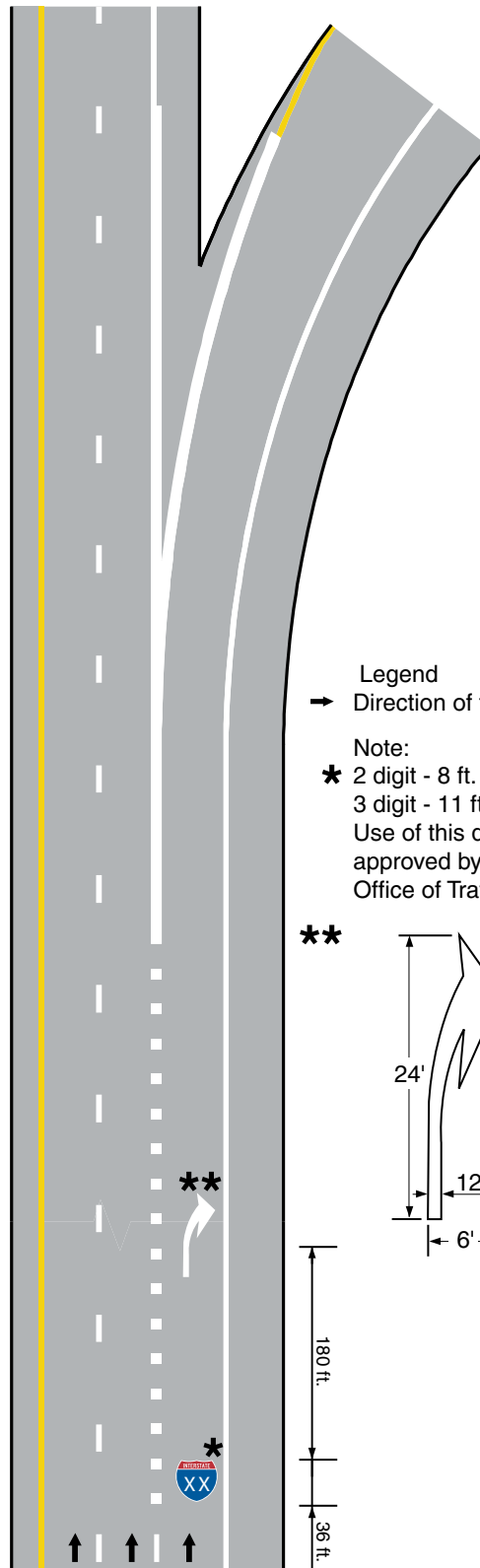
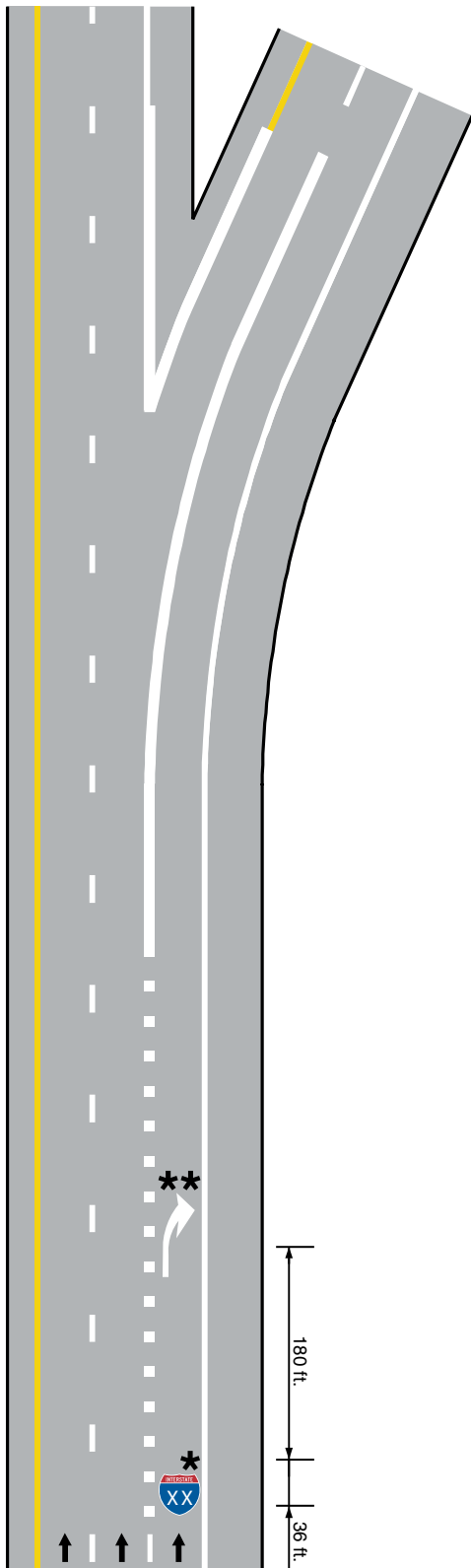

Figure 3B-27h. Examples of Lane-Drops Pavement Markings - Freeway to Freeway

a. Combination Choice Lane/Lane Drop Exit

b. Exit Only Lane



Legend
 → Direction of travel

Note:
 * 2 digit - 8 ft. x 36 ft. Shield
 3 digit - 11 ft. x 36 ft. Shield
 Use of this detail shall be approved by the Director, Office of Traffic & Safety.

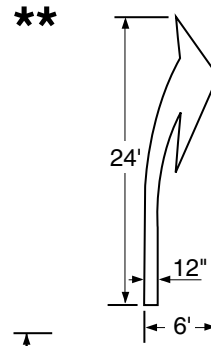
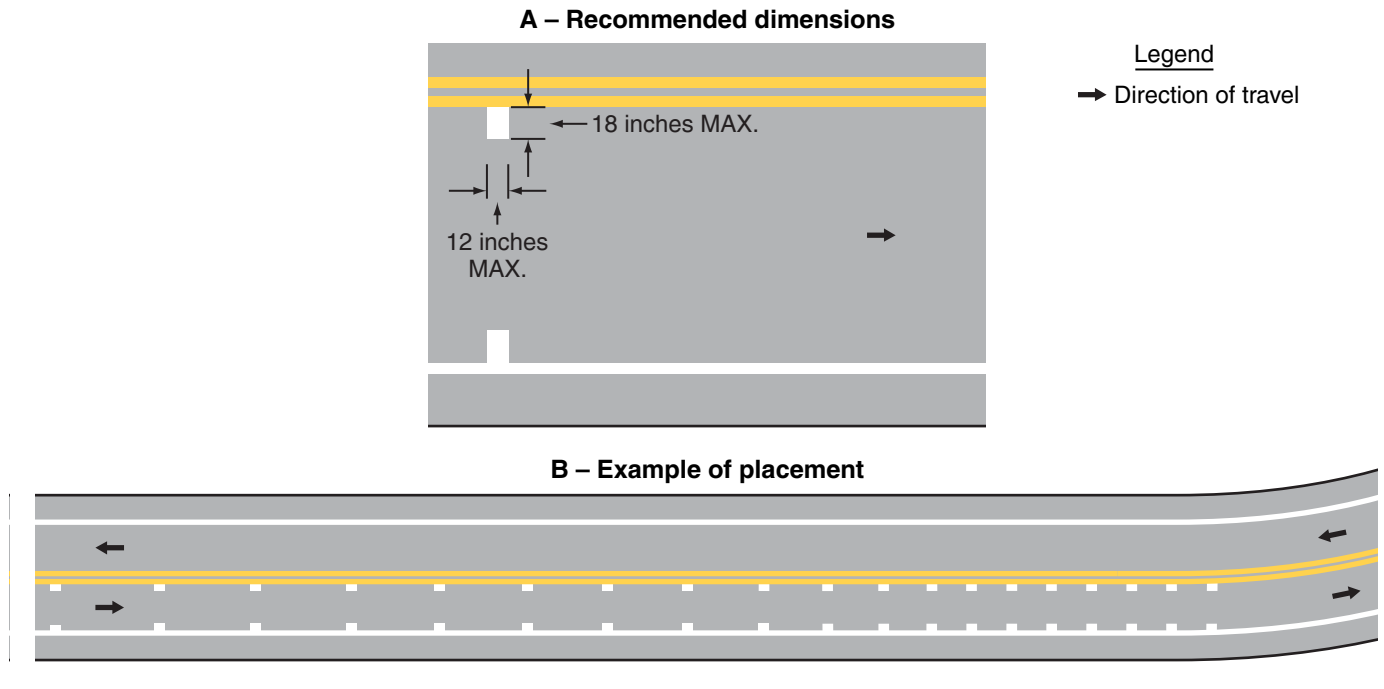

Figure 3B-28. Example of the Application of Speed Reduction Markings**Guidance:**

- 02 *If used, speed reduction markings should be reserved for unexpected curves and should not be used on long tangent sections of roadway or in areas frequented mainly by local or familiar drivers, (e.g., school zones). If used, speed reduction markings should supplement the appropriate warning signs and other traffic control devices and should not substitute for these devices.*

Standard:

- 03 **If used, speed reduction markings shall be a series of white transverse lines on both sides of the lane that are perpendicular to the center line, edge line, or lane line. The longitudinal spacing between the markings shall be progressively reduced from the upstream to the downstream end of the marked portion of the lane.**

Guidance:

- 04 *Speed reduction markings should not be greater than 12 inches in width, and should not extend more than 18 inches into the lane.*

Standard:

- 05 **Speed reduction markings shall not be used in lanes that do not have a longitudinal line (center line, edge line, or lane line) on both sides of the lane.**

Section 3B.23 Curb Markings**Support:**

- 01 Curb markings are most often used to indicate parking regulations or to delineate the curb.

Standard:

- 02 **Where curbs are marked to convey parking regulations in areas where curb markings are frequently obscured by snow and ice accumulation, signs shall be used with the curb markings except as provided in Paragraph 4.**

Guidance:

- 03 *Except provided in Paragraph 4, when curb markings are used without signs to convey parking regulations, a legible word marking regarding the regulation (such as “No Parking” or “No Standing”) should be placed on the curb.*

Option:

- 04 Curb markings without word markings or signs may be used to convey a general prohibition by statute of parking within a specified distance of a STOP sign, YIELD sign, driveway, fire hydrant, or crosswalk.

05 Local highway agencies may prescribe special colors for curb markings to supplement standard signs for parking regulation.

Support:

06 Since yellow and white curb markings are frequently used for curb delineation and visibility, it is advisable to establish parking regulations through the installation of standard signs (see Sections 2B.46 through 2B.48).

Standard:

07 **Where curbs are marked for delineation or visibility purposes, the colors shall comply with the general principles of markings (see Section 3A.05).**

Guidance:

08 *Retroreflective solid yellow markings should be placed on the approach ends of raised medians and curbs of islands that are located in the line of traffic flow where the curb serves to channel traffic to the right of the obstruction.*

09 *Retroreflective solid white markings should be used when traffic is permitted to pass on either side of the island.*

Support:

10 Where the curbs of the islands become parallel to the direction of traffic flow, it is not necessary to mark the curbs unless an engineering study indicates the need for this type of delineation.

11 Curbs at openings in a continuous median island need not be marked unless an engineering study indicates the need for this type of marking.

Option:

12 Retroreflective or internally illuminated raised pavement markers of the appropriate color may be placed on the pavement in front of the curb and/or on the top of curbed noses of raised medians and curbs of islands, as a supplement to or substitute for retroreflective curb markings used for delineation.

Section 3B.24 Chevron and Diagonal Crosshatch Markings

Option:

01 Chevron and diagonal crosshatch markings may be used to discourage travel on certain paved areas, such as shoulders, gore areas, flush median areas between solid double yellow center line markings or between white channelizing lines approaching obstructions in the roadway (see Section 3B.10 and Figure 3B-15), between solid double yellow center line markings forming flush medians or channelized travel paths at intersections (see Figures 3B-2 and 3B-5), buffer spaces between preferential lanes and general-purpose lanes (see Figures 3D-2 and 3D-4), and at grade crossings (see Part 8).

Standard:

02 **When crosshatch markings are used in paved areas that separate traffic flows in the same general direction, they shall be white and they shall be shaped as chevron markings, with the point of each chevron facing toward approaching traffic, as shown in Figure 3B-8, Drawing A of Figure 3B-9, Figure 3B-10, and Drawing C of Figure 3B-15.**

03 **When crosshatch markings are used in paved areas that separate opposing directions of traffic, they shall be yellow diagonal markings that slant away from traffic in the adjacent travel lanes, as shown in Figures 3B-2 and 3B-5 and Drawings A and B of Figure 3B-15.**

04 **When crosshatch markings are used on paved shoulders, they shall be diagonal markings that slant away from traffic in the adjacent travel lane. The diagonal markings shall be yellow when used on the left-hand shoulders of the roadways of divided highways and on the left-hand shoulders of one-way streets or ramps. The diagonal markings shall be white when used on right-hand shoulders.**

Guidance:

05 *The chevrons and diagonal lines used for crosshatch markings should be at least 12 inches wide for roadways having a posted or statutory speed limit of 45 mph or greater, and at least 8 inches wide for roadways having posted or statutory speed limit of less than 45 mph. The longitudinal spacing of the chevrons or diagonal lines should be determined by engineering judgment considering factors such as speeds and desired visual impacts. The chevrons and diagonal lines should form an angle of approximately 30 to 45 degrees with the longitudinal lines that they intersect.*

Section 3B.25 Speed Hump Markings**Standard:**

- 01 **If speed hump markings are used, they shall be a series of white markings placed on a speed hump to identify its location. If markings are used for a speed hump that does not also function as a crosswalk or speed table, the markings shall comply with Option A, B, or C shown in Figure 3B-29. If markings are used for a speed hump that also functions as a crosswalk or speed Table, the markings shall comply with Option A or B shown in Figure 3B-30.**

Section 3B.26 Advance Speed Hump Markings**Option:**

- 01 Advance speed hump markings (see Figure 3B-31) may be used in advance of speed humps or other engineered vertical roadway deflections such as dips where added visibility is desired or where such deflection is not expected.
- 02 Advance pavement wording such as BUMP or HUMP (see Section 3B.20) may be used on the approach to a speed hump either alone or in conjunction with advance speed hump markings. Appropriate advance warning signs may be used in compliance with Section 2C.29.

Standard:

- 03 **If advance speed hump markings are used, they shall be a series of eight white 12-inch transverse lines that become longer and are spaced closer together as the vehicle approaches the speed hump or other deflection. If advance markings are used, they shall comply with the detailed design shown in Figure 3B-31.**

Guidance:

- 04 *If used, advance speed hump markings should be installed in each approach lane.*

Figure 3B-29. Pavement Markings for Speed Humps without Crosswalks

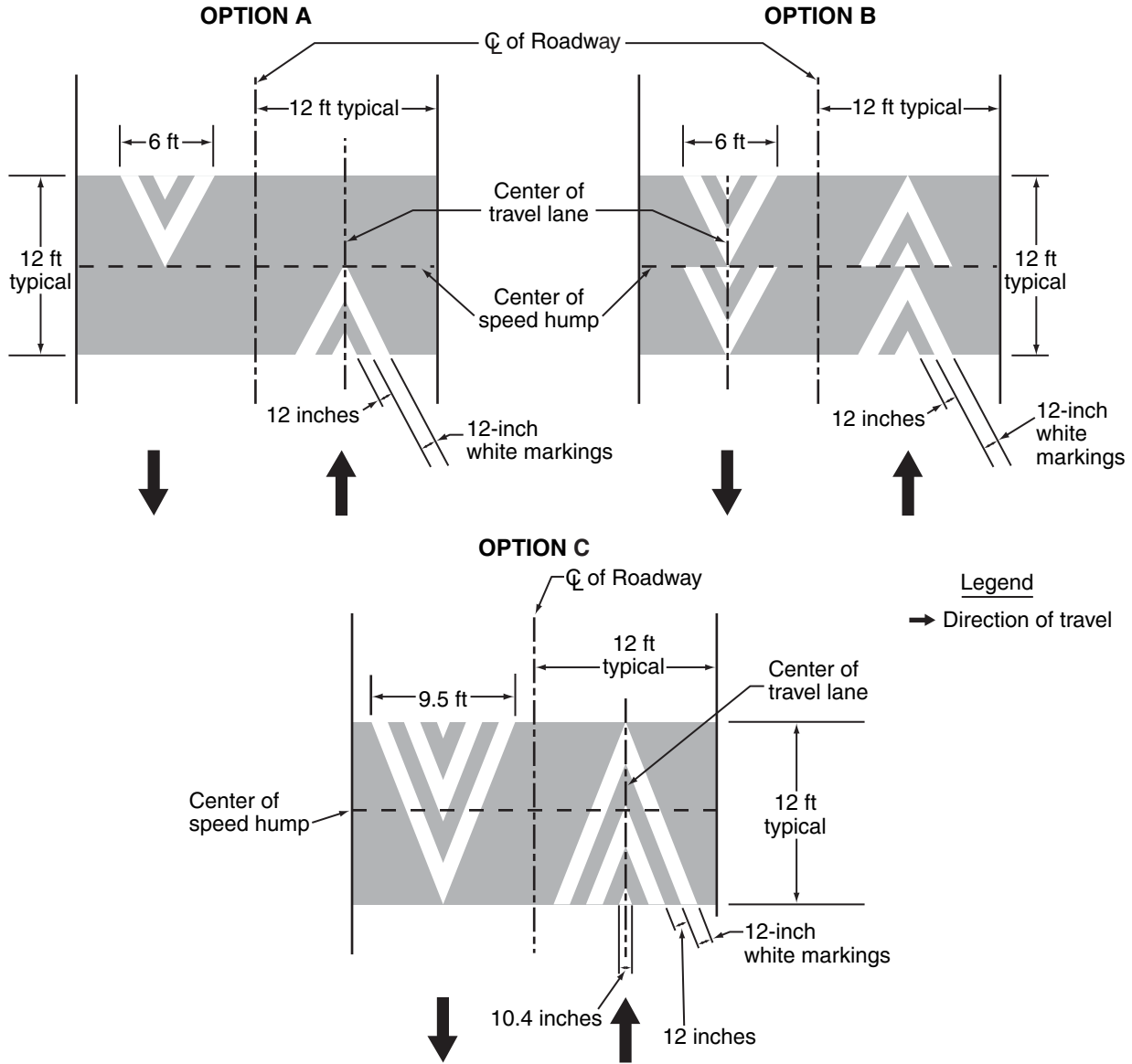
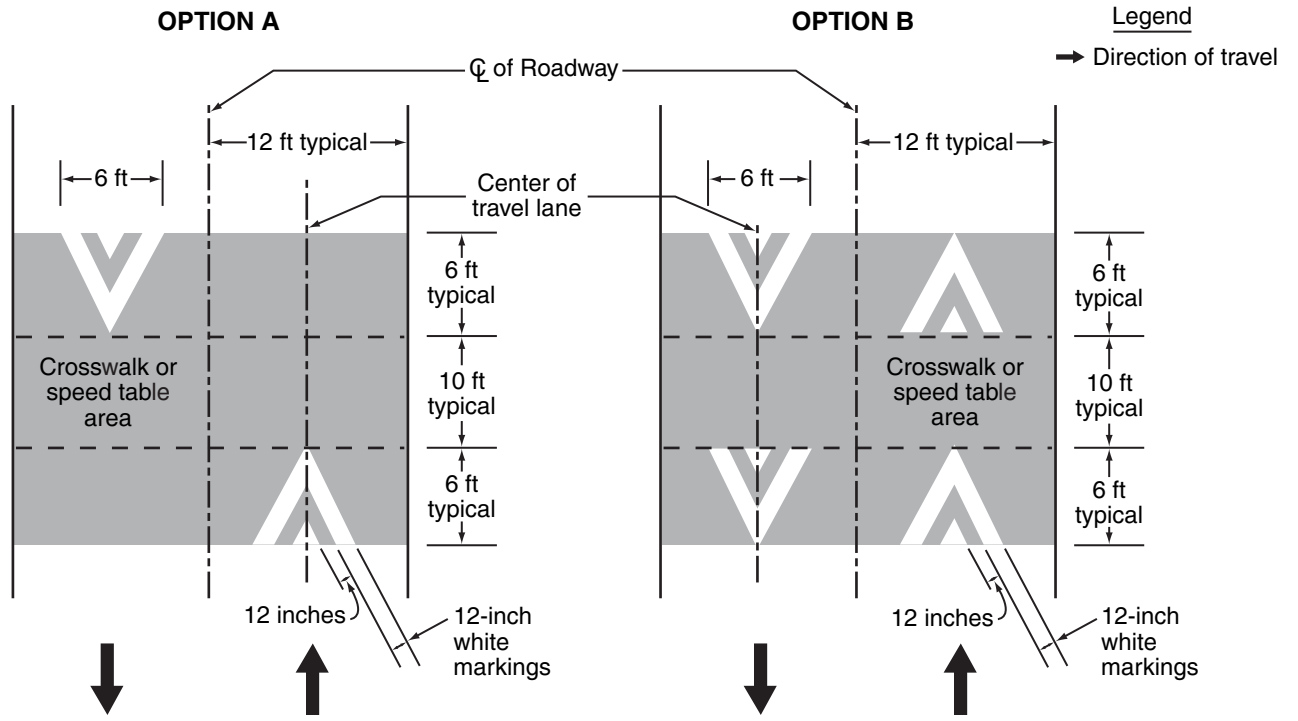
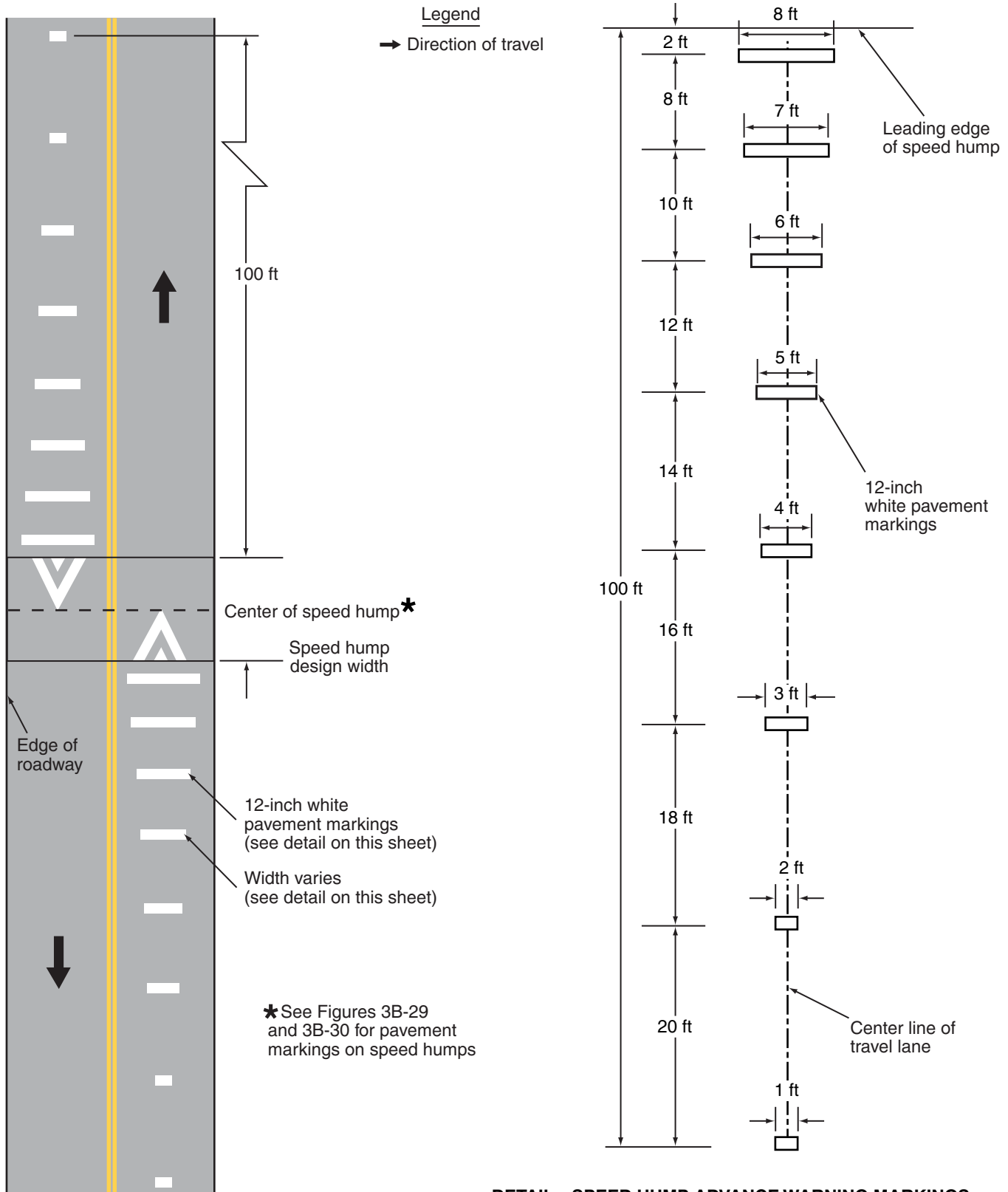

Figure 3B-30. Pavement Markings for Speed Tables or Speed Humps with Crosswalks



Note: Optional crosswalk lines are not shown in this figure

Figure 3B-31. Advance Warning Markings for Speed Humps



CHAPTER 3C. ROUNDABOUT MARKINGS

Section 3C.01 General

Support:

- 01 A roundabout (see definition in Section 1A.13) is a specific type of circular intersection designed to control speeds and having specific traffic control features.

Standard:

- 01a **For State owned, operated, and maintained intersections, the “Roundabout Traffic Design Guideline” shall be used to design markings for roundabout intersections.**

Support:

- 01b The “Roundabout Traffic Design Guideline” can be obtained from the Maryland State Highway Administration’s Office of Traffic & Safety, Traffic Development & Support Division (TDSD) at the address shown on Page i.

Guidance:

- 02 *Pavement markings and signing for a roundabout should be integrally designed to correspond to the geometric design and intended lane use of a roundabout.*
- 03 *Markings on the approaches to a roundabout and on the circular roadway should be compatible with each other to provide a consistent message to road users and should facilitate movement through the roundabout such that vehicles do not have to change lanes within the circulatory roadway in order to exit the roundabout in a given direction.*

Support:

- 04 Figure 3C-1 provides an example of the pavement markings for approach and circulatory roadways at a roundabout. Figure 3C-2 shows the options that are available for lane-use pavement marking arrows on approaches to roundabouts. Figures 3C-3 through 3C-14 illustrate examples of markings for roundabouts of various geometric and lane-use configurations.
- 05 Traffic control signals or pedestrian hybrid beacons (see Part 4) are sometimes used at roundabouts to facilitate the crossing of pedestrians or to meter traffic. **The pedestrian hybrid beacons are not used in Maryland.**
- 06 Section 8C.12 contains information about roundabouts that contain or are in close proximity to grade crossings.

Figure 3C-1. Example of Markings for Approach and Circulatory Roadways at a Roundabout

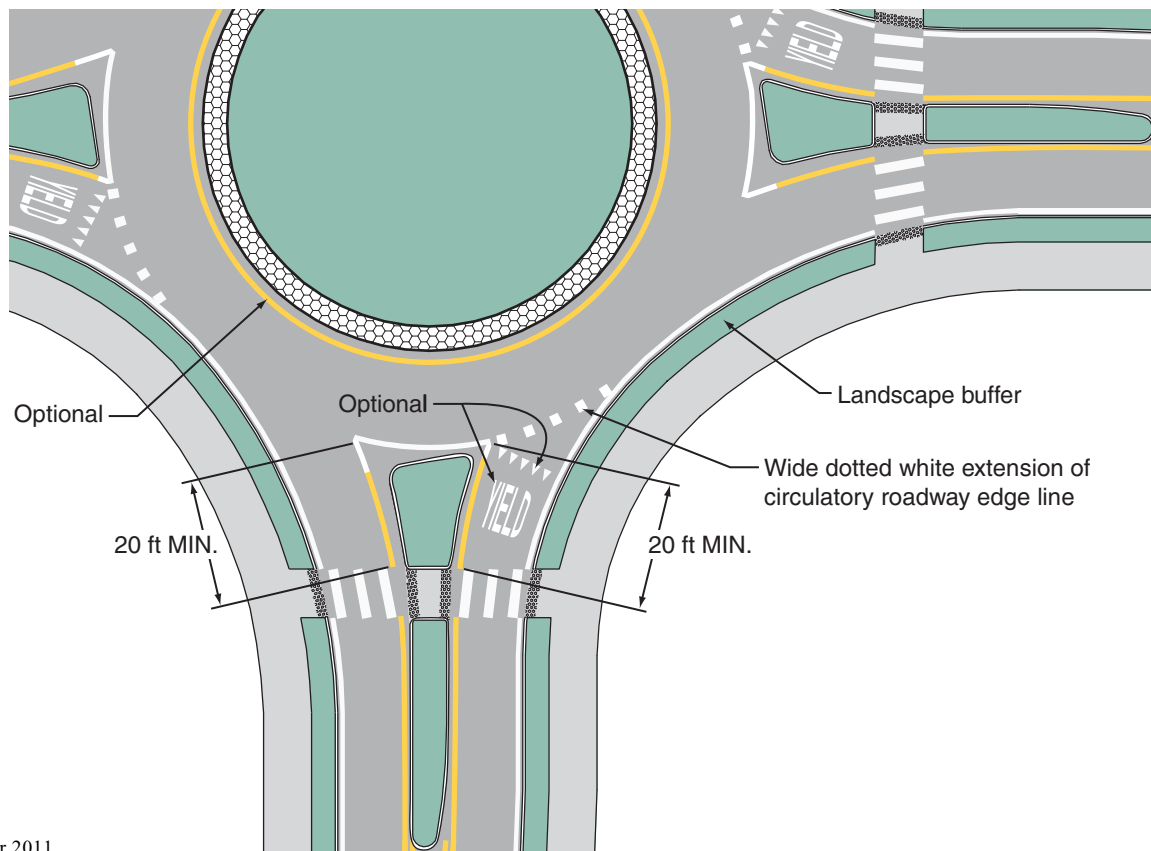

Figure 3C-2. Lane-Use Arrow Pavement Marking Options for Roundabout Approaches

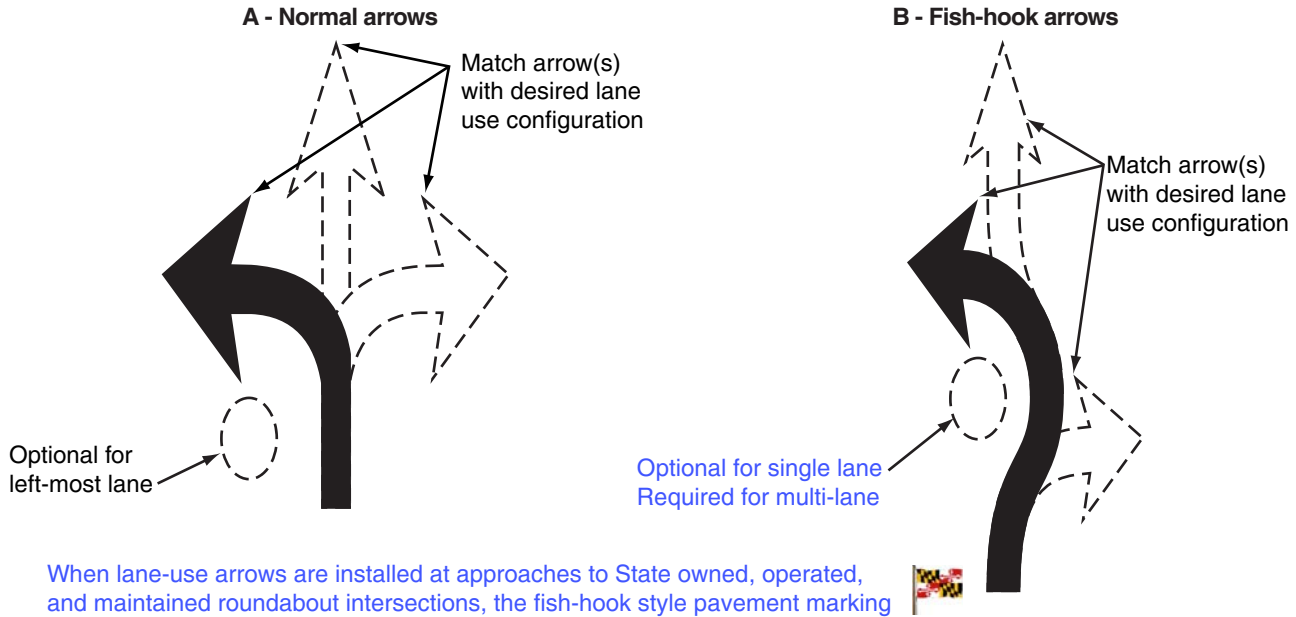

Figure 3C-3. Example of Markings for a One-Lane Roundabout

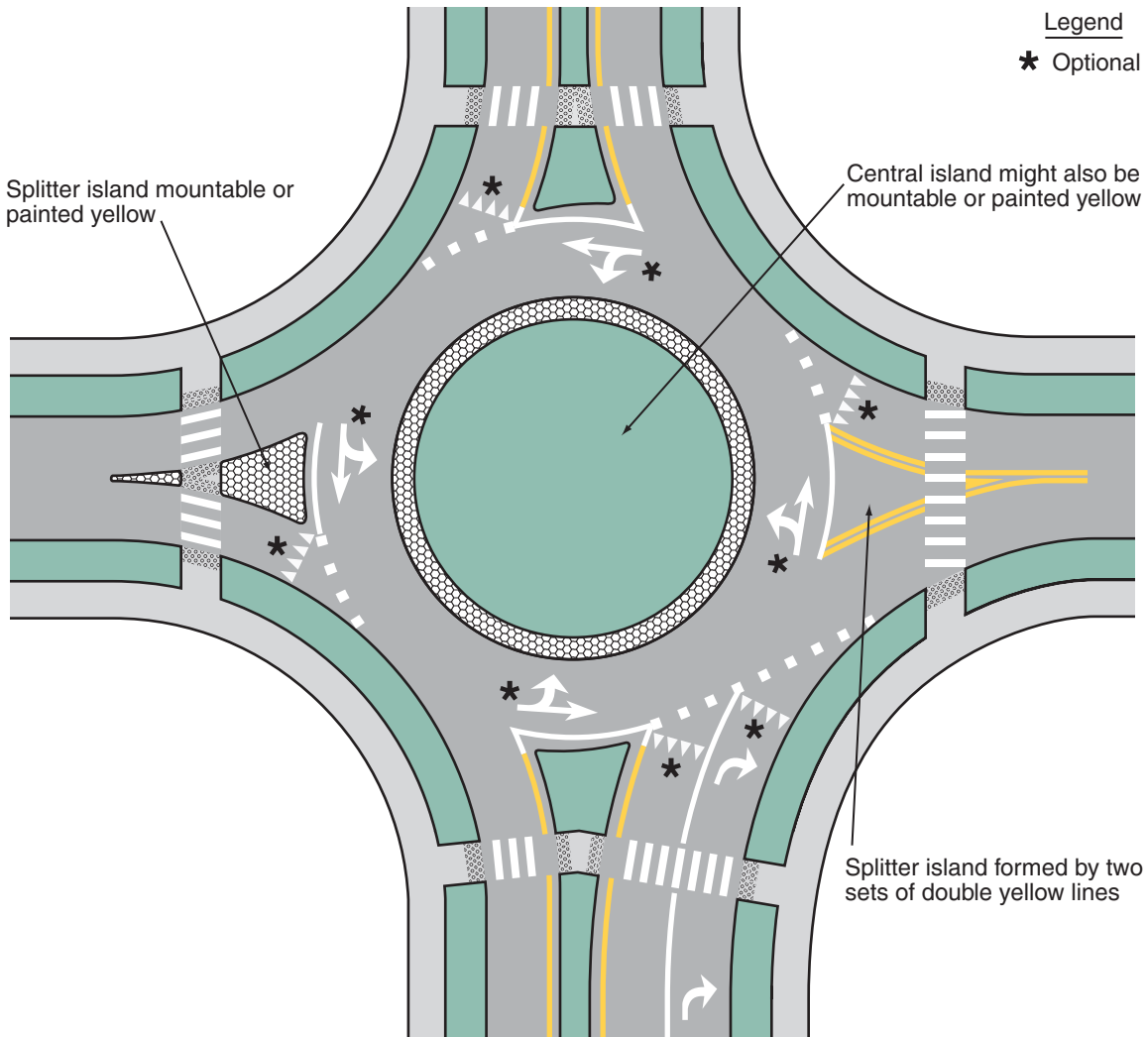

Figure 3C-4. Example of Markings for a Two-Lane Roundabout with One- and Two-Lane Approaches (Sheet 1 of 2)

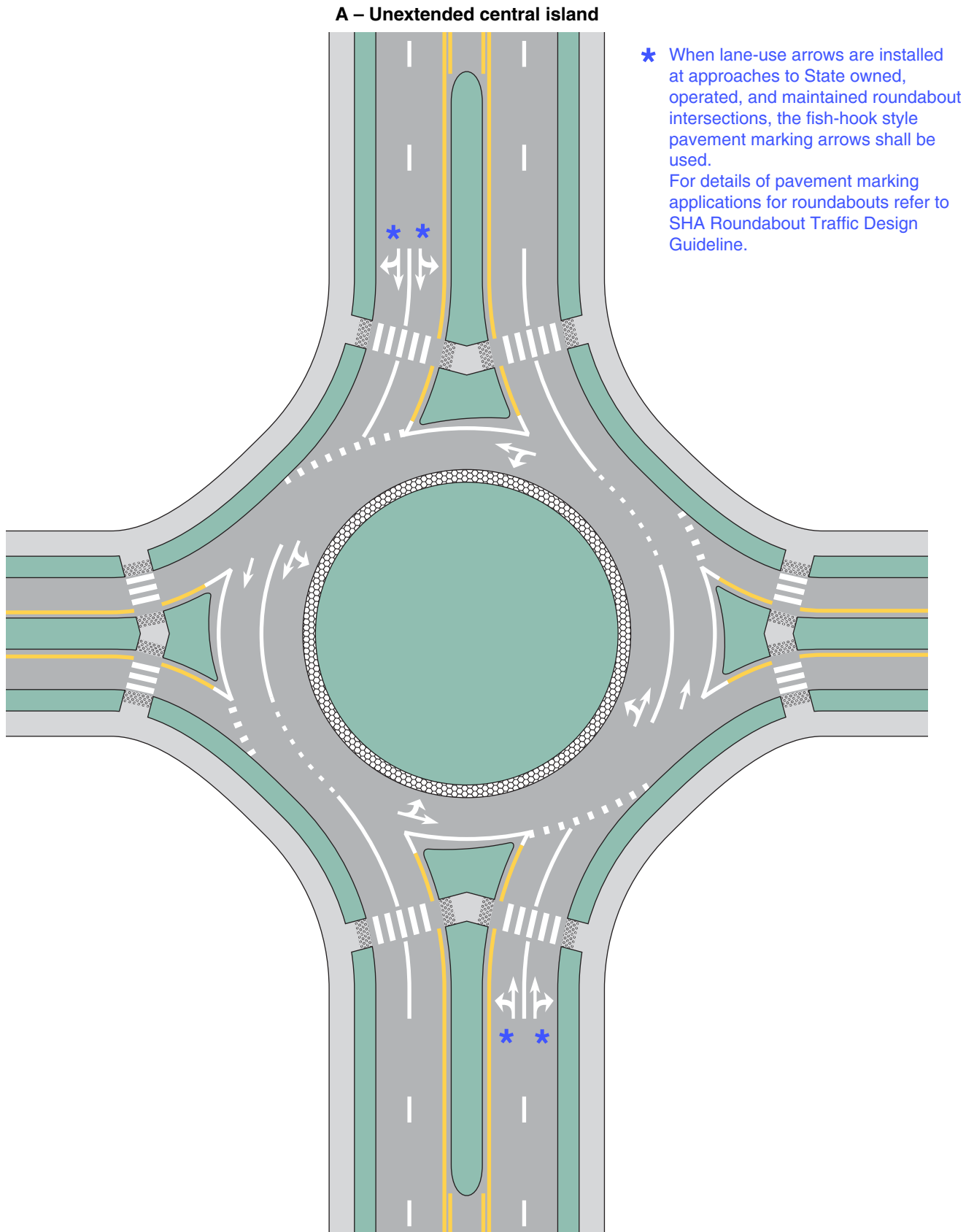
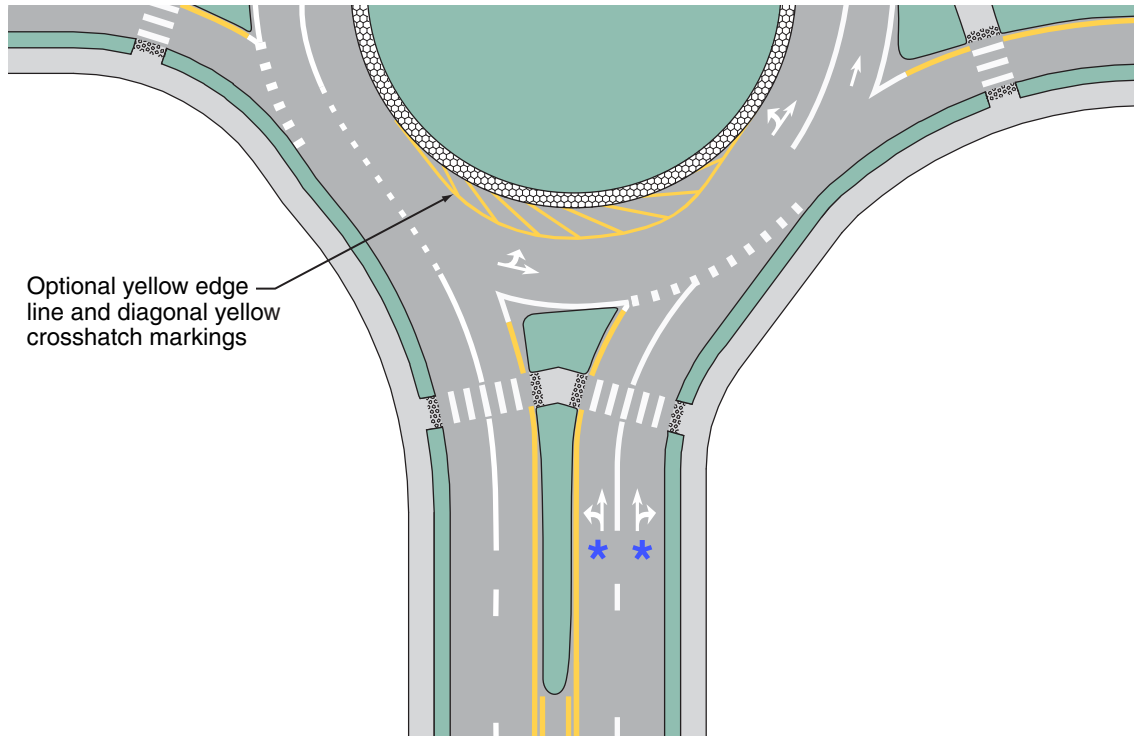

Figure 3C-4. Example of Markings for a Two-Lane Roundabout with One- and Two-Lane Approaches (Sheet 2 of 2)

B – Central island extended by pavement markings



Optional yellow edge line and diagonal yellow crosshatch markings

C – Central island extended by a truck apron

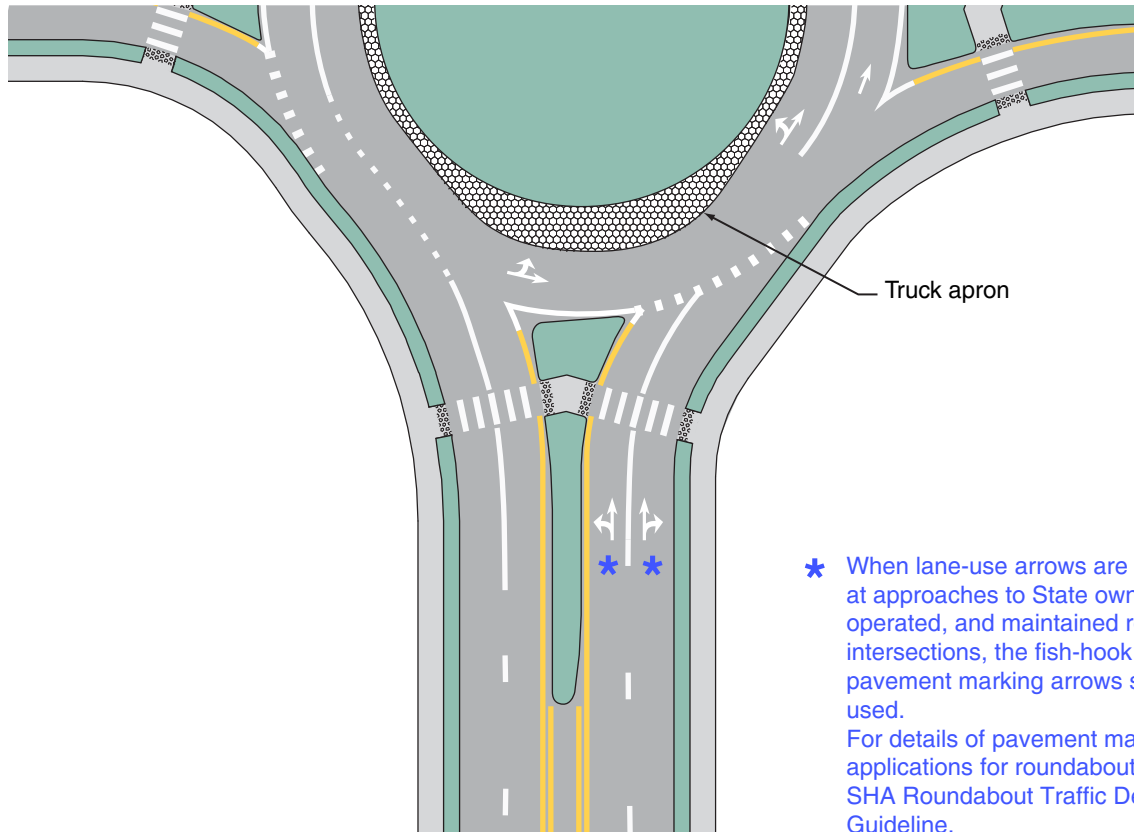

Truck apron

* When lane-use arrows are installed at approaches to State owned, operated, and maintained roundabout intersections, the fish-hook style pavement marking arrows shall be used. For details of pavement marking applications for roundabouts refer to SHA Roundabout Traffic Design Guideline.

Figure 3C-5. Example of Markings for a Two-Lane Roundabout with One-Lane Exits

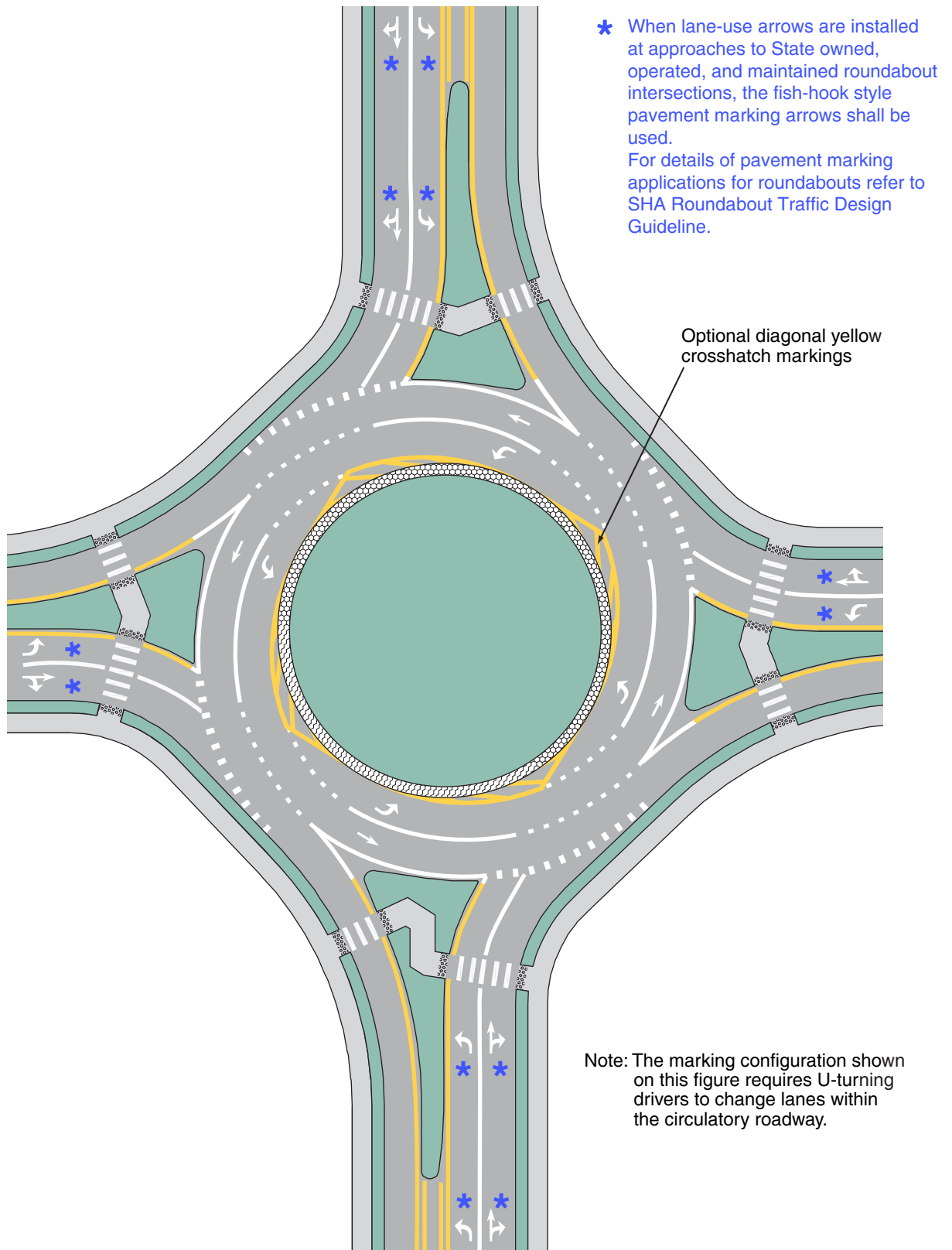
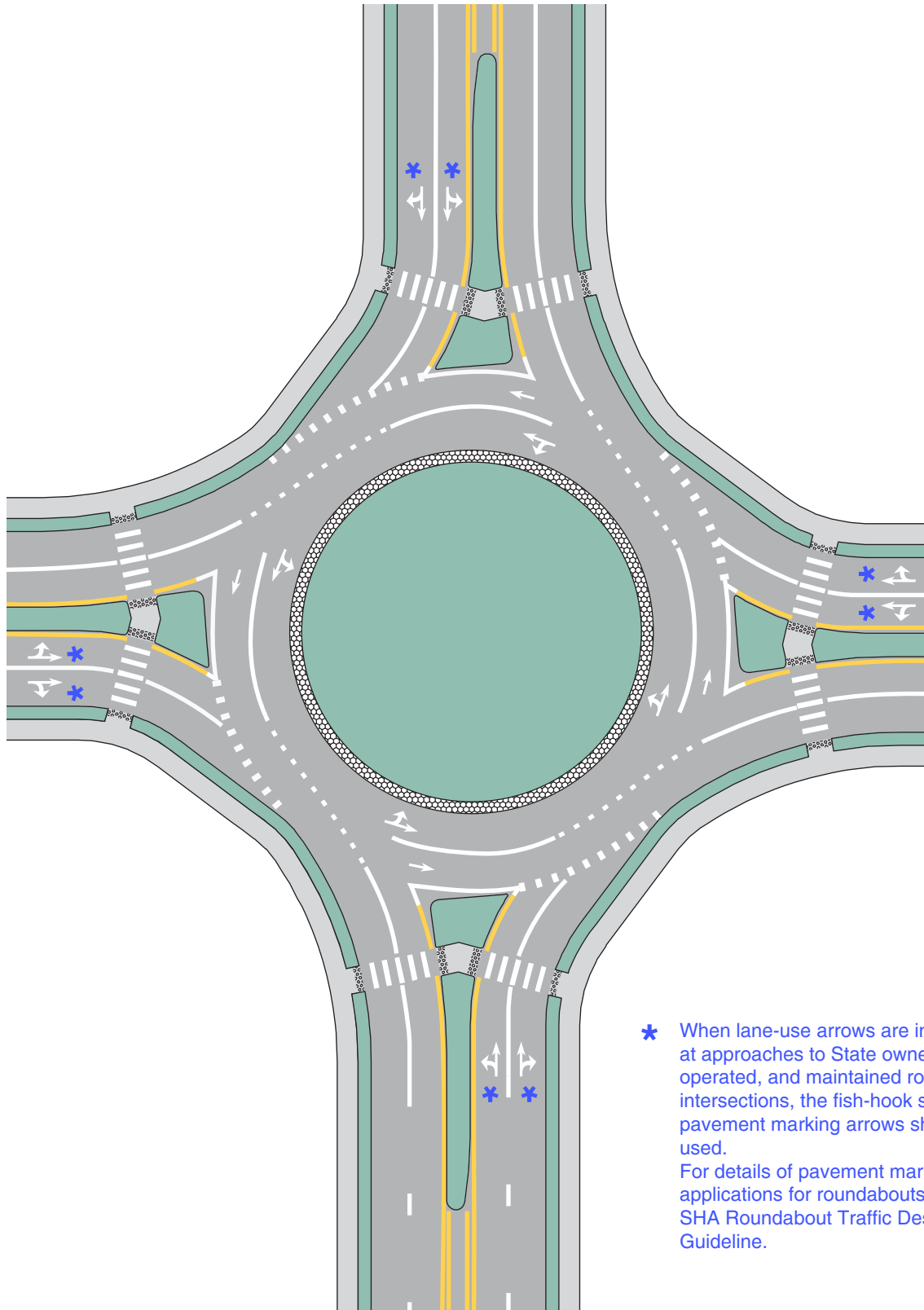
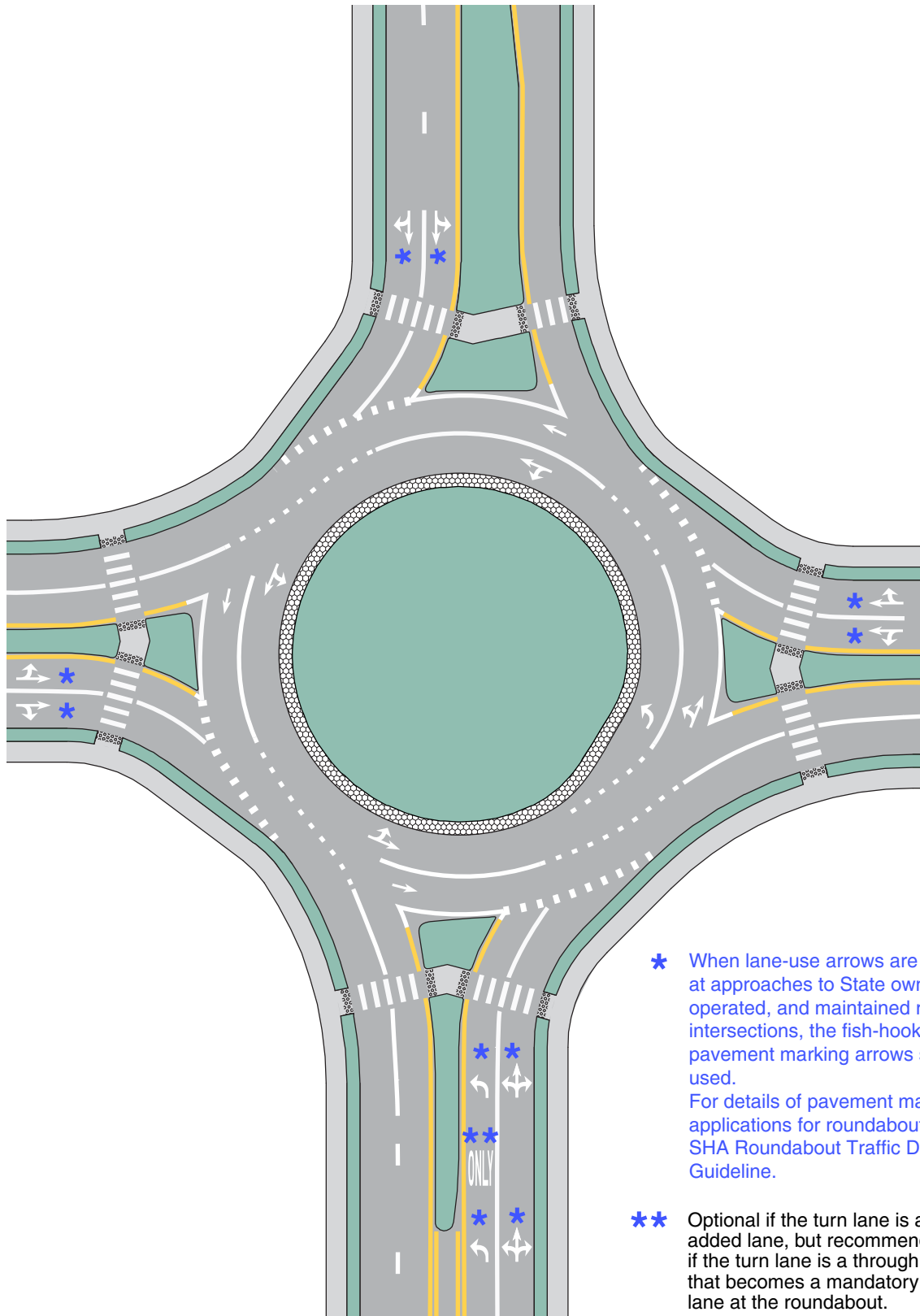

Figure 3C-6. Example of Markings for a Two-Lane Roundabout with Two-Lane Exits



- * When lane-use arrows are installed at approaches to State owned, operated, and maintained roundabout intersections, the fish-hook style pavement marking arrows shall be used. For details of pavement marking applications for roundabouts refer to SHA Roundabout Traffic Design Guideline.

Figure 3C-7. Example of Markings for a Two-Lane Roundabout with a Double Left Turn



* When lane-use arrows are installed at approaches to State owned, operated, and maintained roundabout intersections, the fish-hook style pavement marking arrows shall be used. For details of pavement marking applications for roundabouts refer to SHA Roundabout Traffic Design Guideline.

** Optional if the turn lane is an added lane, but recommended if the turn lane is a through lane that becomes a mandatory turn lane at the roundabout.

Figure 3C-8. Example of Markings for a Two-Lane Roundabout with a Double Right Turn

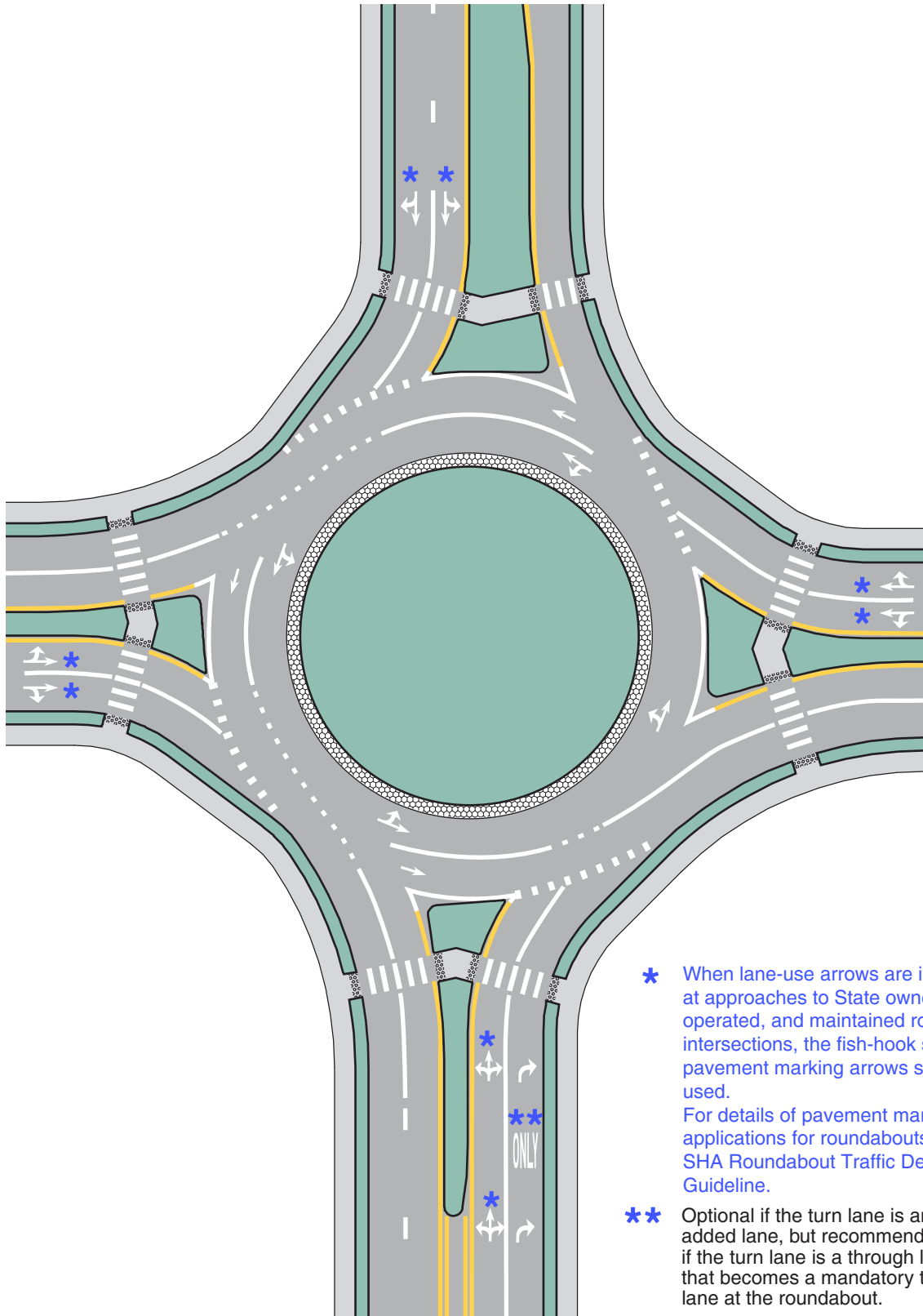

- * When lane-use arrows are installed at approaches to State owned, operated, and maintained roundabout intersections, the fish-hook style pavement marking arrows shall be used. For details of pavement marking applications for roundabouts refer to SHA Roundabout Traffic Design Guideline.
- ** Optional if the turn lane is an added lane, but recommended if the turn lane is a through lane that becomes a mandatory turn lane at the roundabout.

Figure 3C-9. Example of Markings for a Two-Lane Roundabout with Consecutive Double Left Turns

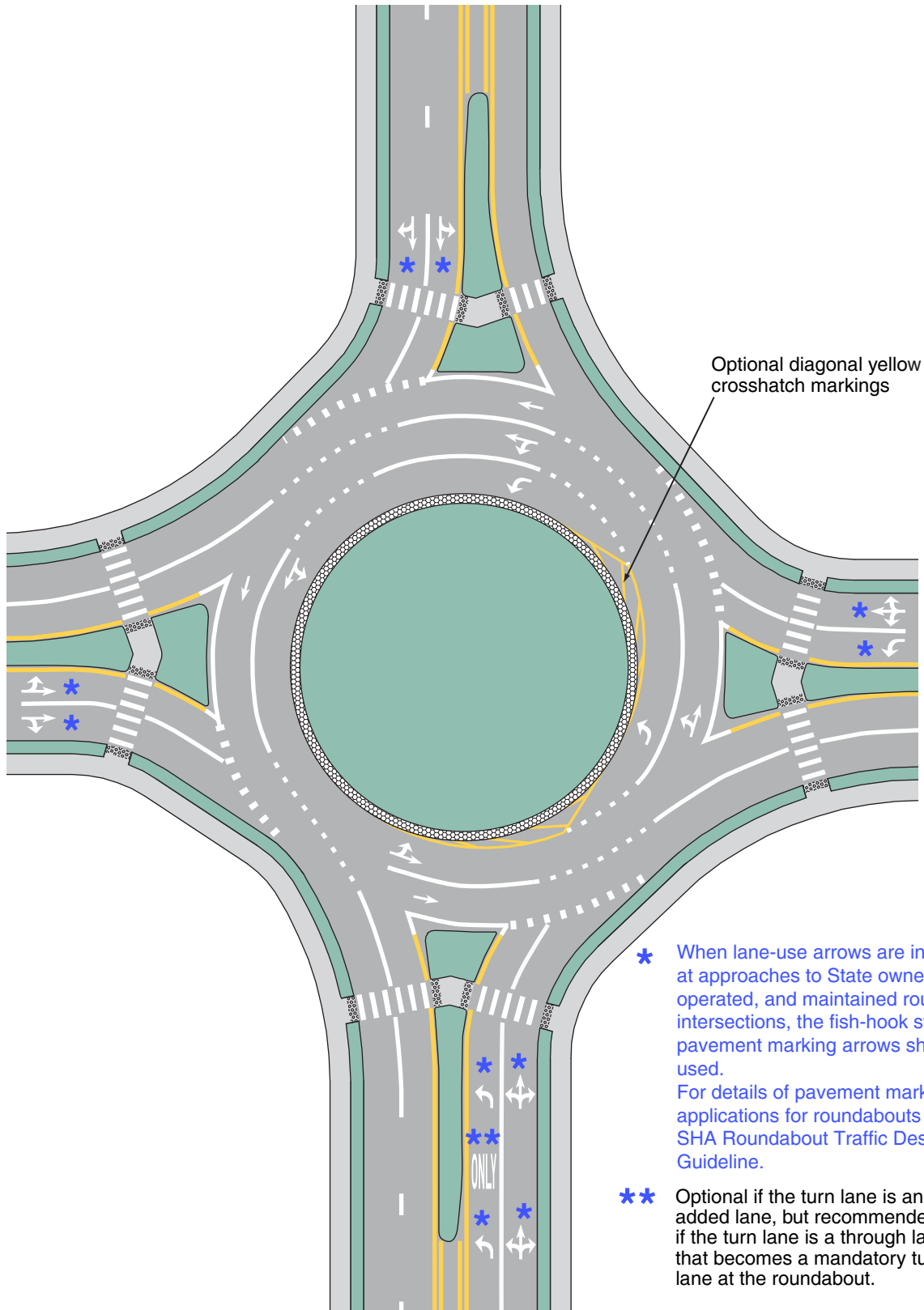

Figure 3C-10. Example of Markings for a Three-Lane Roundabout with Two- and Three-Lane Approaches

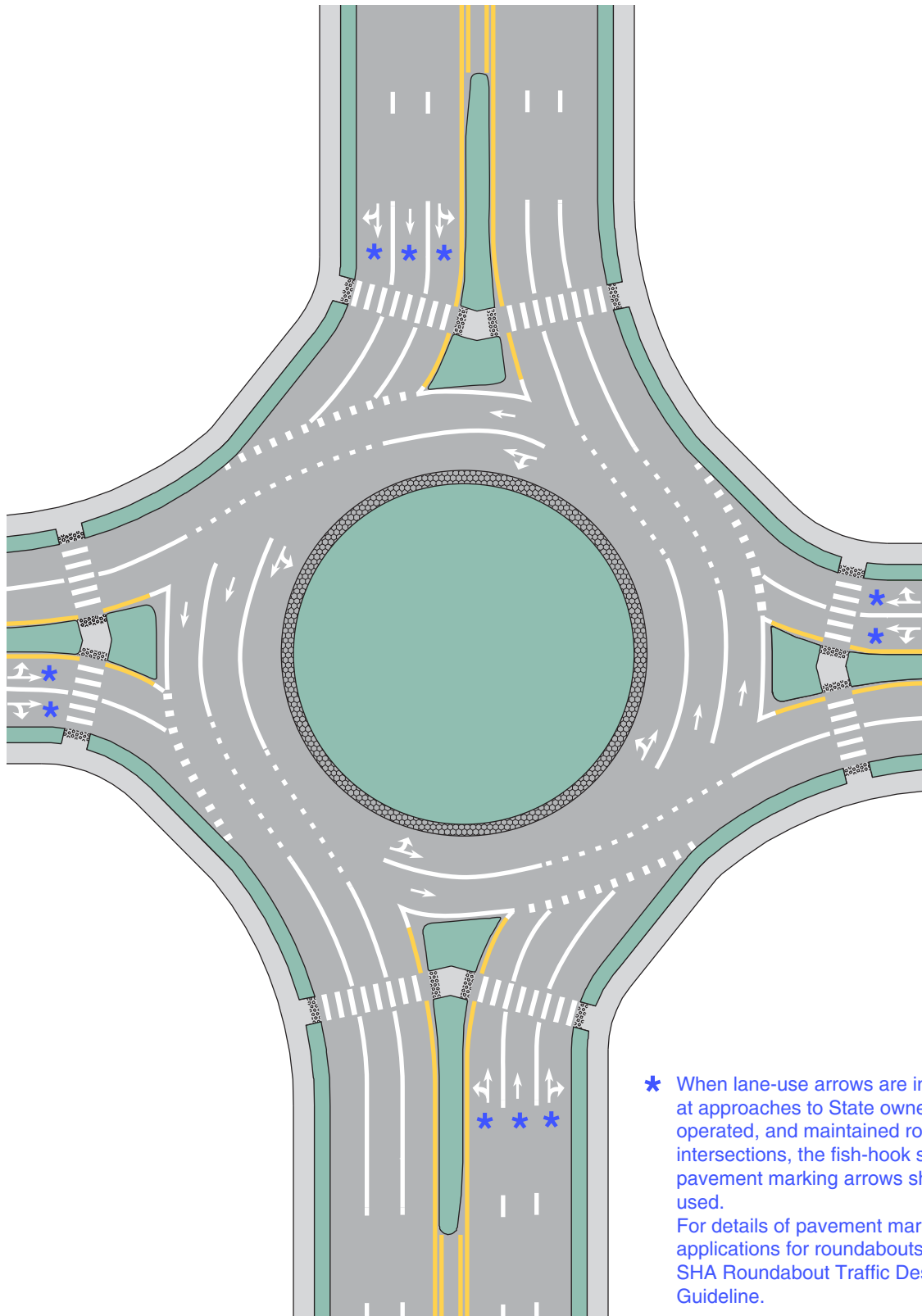

Figure 3C-11. Example of Markings for a Three-Lane Roundabout with Three-Lane Approaches

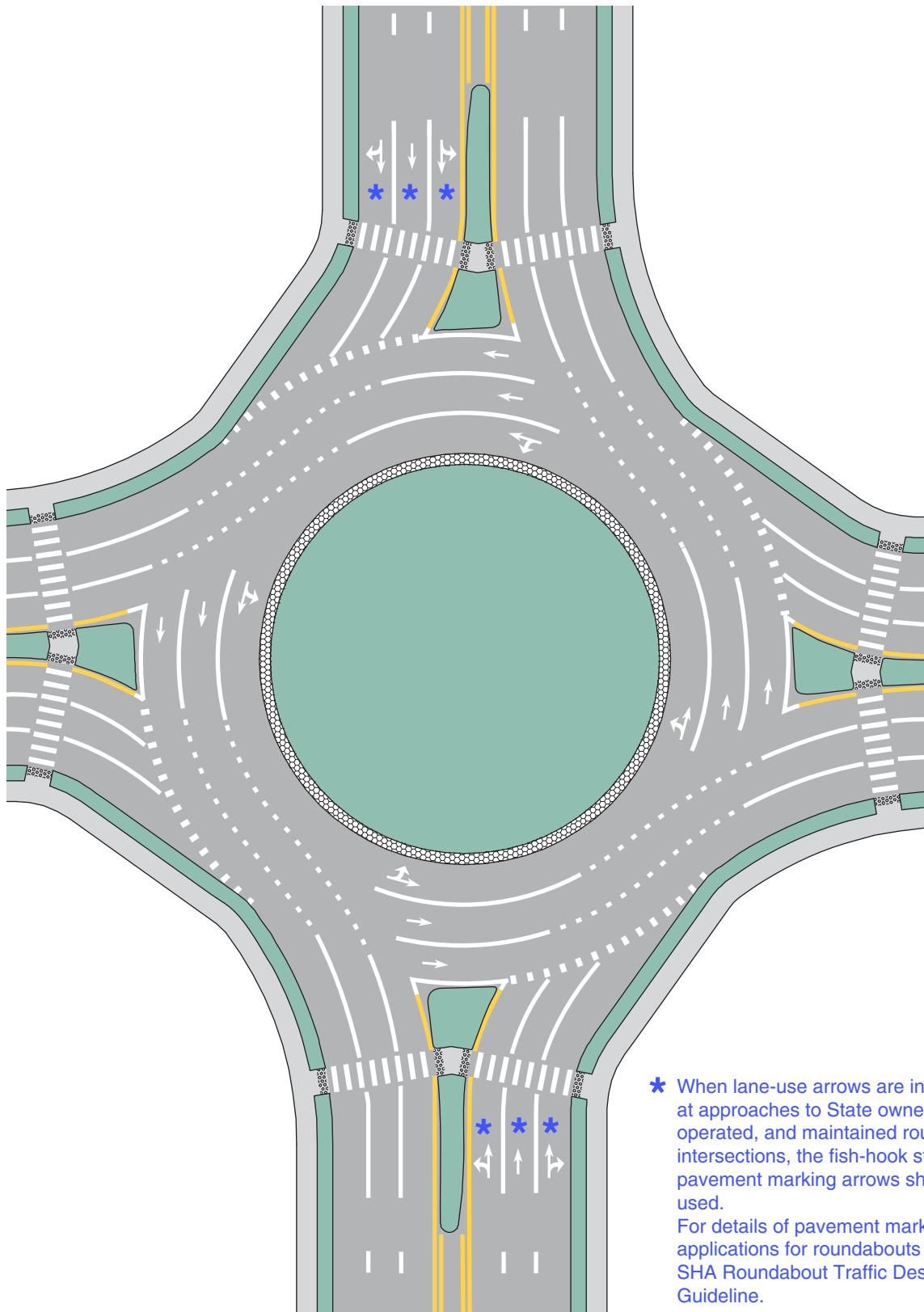

Figure 3C-12. Example of Markings for a Three-Lane Roundabout with Two-Lane Exits

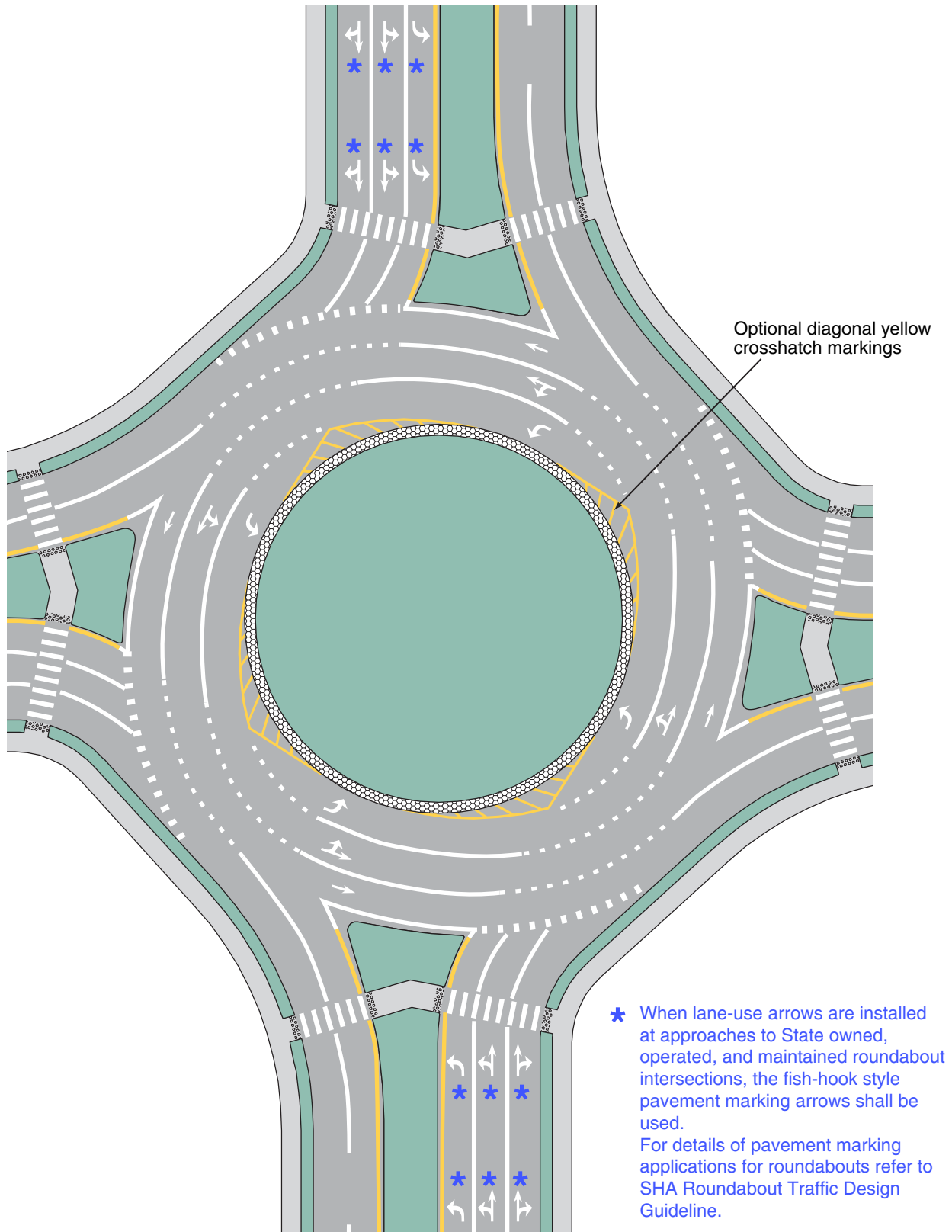
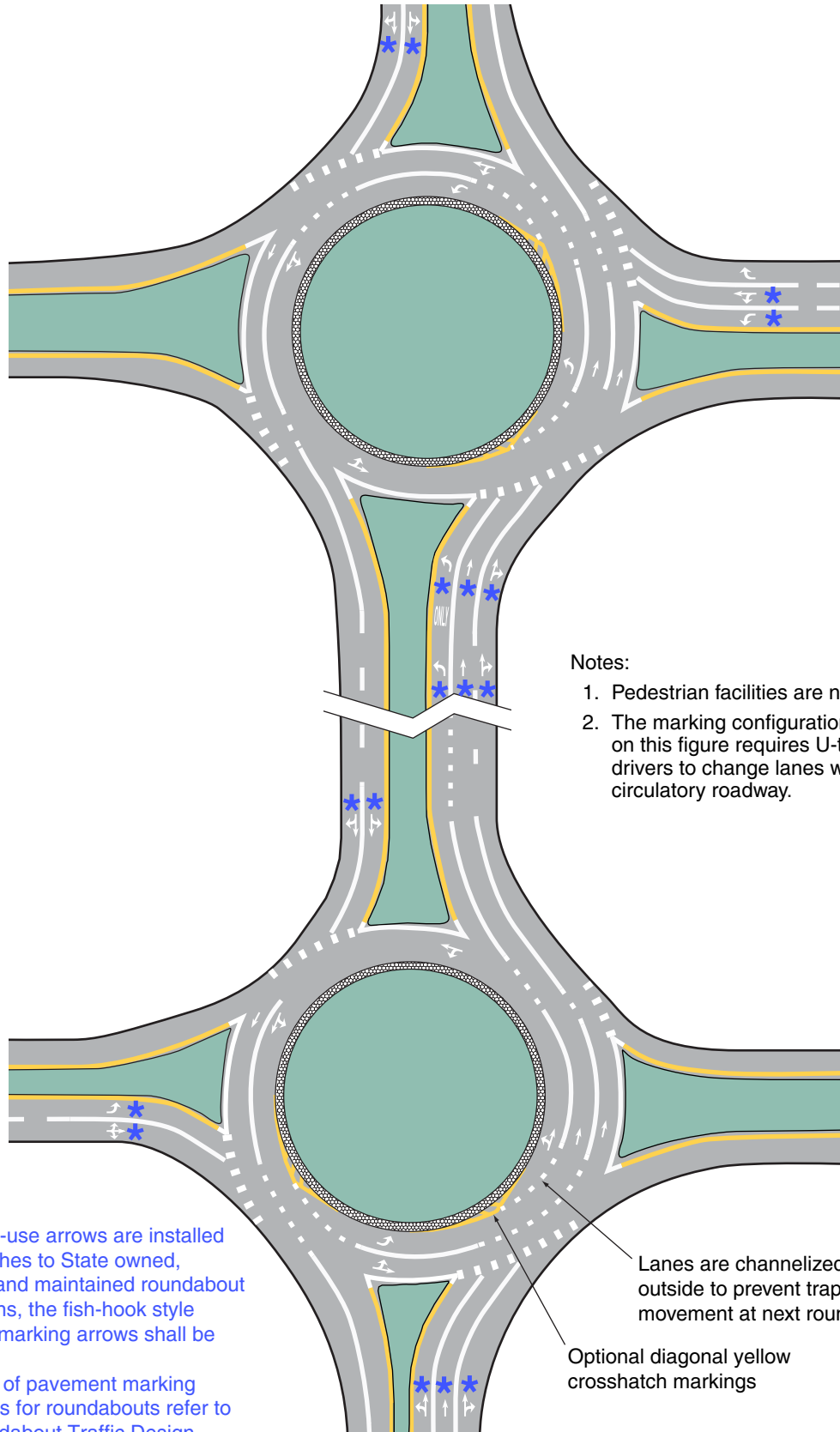

Figure 3C-13. Example of Markings for Two Linked Roundabouts



Notes:

1. Pedestrian facilities are not shown.
2. The marking configuration shown on this figure requires U-turning drivers to change lanes within the circulatory roadway.

* When lane-use arrows are installed at approaches to State owned, operated, and maintained roundabout intersections, the fish-hook style pavement marking arrows shall be used. For details of pavement marking applications for roundabouts refer to SHA Roundabout Traffic Design Guideline.

Lanes are channelized to the outside to prevent trapping movement at next roundabout.
Optional diagonal yellow crosshatch markings

Figure 3C-14. Example of Markings for a Diamond Interchange with Two Circular-Shaped Roundabout Ramp Terminals

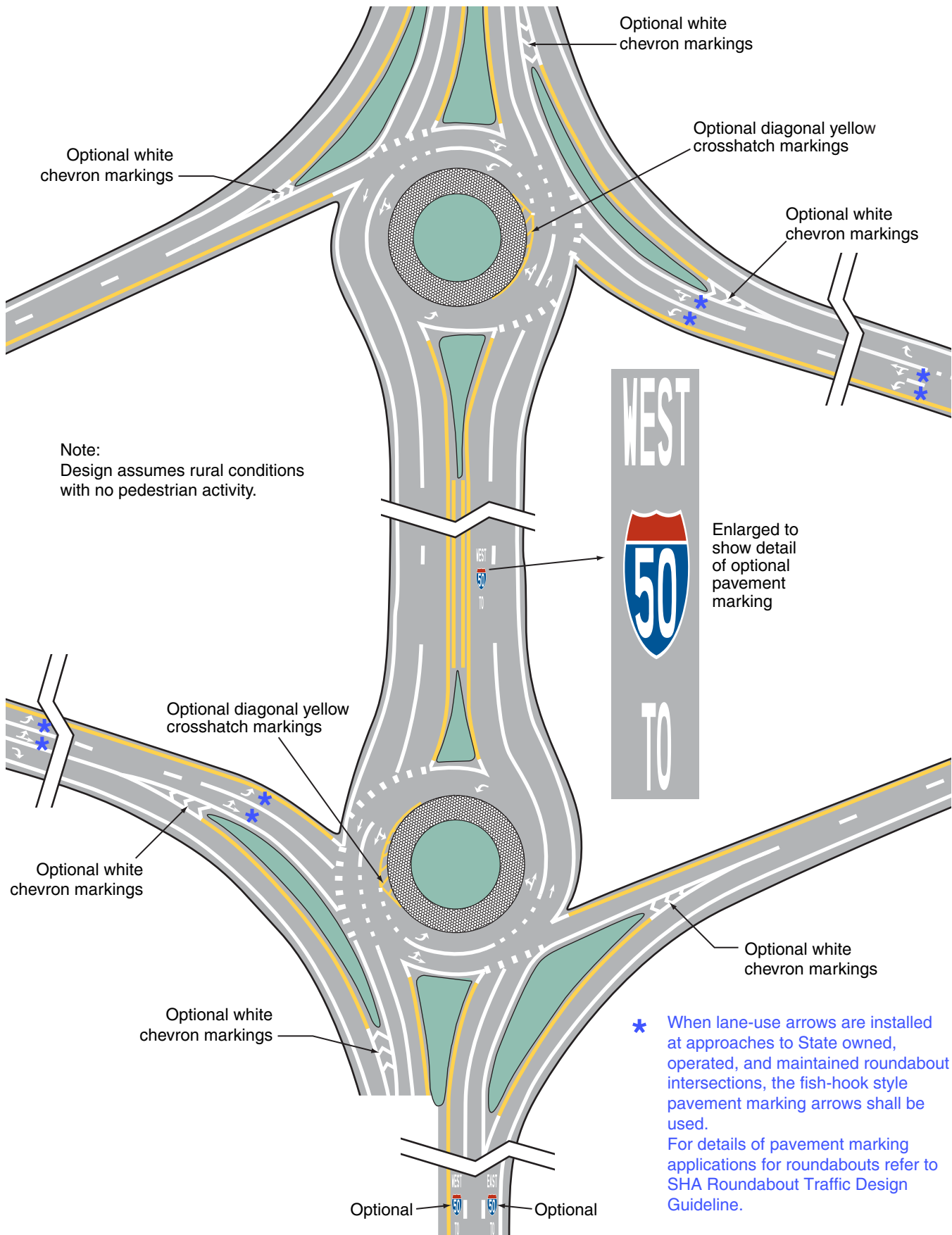

Section 3C.02 White Lane Line Pavement Markings for Roundabouts

Standard:

01 **Multi-lane approaches to roundabouts shall have lane lines.**

02 **A through lane on a roadway that becomes a dropped lane (mandatory turn lane) at a roundabout shall be marked with a dotted white lane line in accordance with Section 3B.04.**

Guidance:

03 *Multi-lane roundabouts should have lane line markings within the circulatory roadway to channelize traffic to the appropriate exit lane.*

Standard:

04 **Continuous concentric lane lines shall not be used within the circulatory roadway of roundabouts.**

Support:

05 Section 9C.04 contains information regarding bicycle lane markings at roundabouts.

Section 3C.03 Edge Line Pavement Markings for Roundabout Circulatory Roadways

Guidance:

01 *A white edge line should be used on the outer (right-hand) side of the circulatory roadway.*

02 *Where a white edge line is used for the circulatory roadway, it should be as follows (see Figure 3C-1):*

A. A solid line adjacent to the splitter island, and

B. A wide dotted line across the lane(s) entering the roundabout.

Standard:

03 **Edge lines and edge line extensions shall not be placed across the exits from the circulatory roadway at roundabouts.**

Option:

04 A yellow edge line may be placed around the inner (left-hand) edge of the circulatory roadway (see Figure 3C-1) and may be used to channelize traffic (see Drawing B of Figure 3C-4).

Section 3C.04 Yield Lines for Roundabouts

Option:

01 A yield line (see Section 3B.16) may be used to indicate the point behind which vehicles are required to yield at the entrance to roundabout (see Figure 3C-1).

Section 3C.05 Crosswalk Markings at Roundabouts

Standard:

01 **Pedestrian crosswalks shall not be marked to or from the central island of roundabouts.**

Guidance:

02 *If pedestrian facilities are provided, crosswalks (see Section 3B.18) should be marked across roundabout entrances and exits to indicate where pedestrians are intended to cross.*

03 Crosswalks should be a minimum of 20 feet from the edge of the circulatory roadway.

Support:

04 Various arrangements of crosswalks at roundabouts are illustrated in the figures in this Chapter.

Section 3C.06 Word, Symbol, and Arrow Pavement Markings for Roundabouts

Option:

01 Lane-use arrows may be used on any approach to and within the circulatory roadway of any roundabout.

02 YIELD (word) and YIELD AHEAD (symbol or word) pavement markings (see Figure 3C-1) may be used on approaches to roundabouts.

03 Word and/or route shield pavement markings may be used on an approach to or within the circulatory roadway of a roundabout to provide route and/or destination guidance information to road users (see Figure 3C-14).

Guidance:

04 Within the circulatory roadway of multi-lane roundabouts, normal lane-use arrows (see Section 3B.20 and Figure 3B-24) should be used.

05 On multi-lane approaches with double left-turn and/or double right-turn lanes, lane-use arrows as shown in
Figures 3C-7 and 3C-8 should be used.

Option:

06 If used on approaches to a roundabout, lane-use arrows may be either normal or fish-hook arrows, either with
or without an oval symbolizing the central island, as shown in Figure 3C-2.

Section 3C.07 Markings for Other Circular Intersections

Support:

01 Other circular intersections include, but are not limited to, rotaries, traffic circles, and residential traffic
calming designs.

Option:

02 The markings shown in this Chapter may be used at other circular intersections if engineering judgment
indicates that their presence will benefit drivers, pedestrians, or other road users.

CHAPTER 3D. MARKINGS FOR PREFERENTIAL LANES

Section 3D.01 Preferential Lane Word and Symbol Markings

Support:

- 01 Preferential lanes are established for one or more of a wide variety of special uses, including, but not limited to, high-occupancy vehicle (HOV) lanes, ETC lanes, high-occupancy toll (HOT) lanes, bicycle lanes, bus only lanes, taxi only lanes, and light rail transit only lanes.

Standard:

- 01a **On State owned, operated, and maintained roadways, ETL and toll plaza pavement markings shall conform to the Maryland Transportation Authority Standards.**

Support:

- 01b The ETL and toll plaza pavement markings standards can be obtained from the Maryland Transportation Authority's Traffic Manager at the address shown on Page i.
- 02 **When a lane is assigned full or part time to a particular class or classes of vehicles, the preferential lane word and symbol markings described in this Section and the preferential lane longitudinal markings described in Section 3D.02 shall be used.**
- 02a **When a preferential lane is added via a lane addition, the preferential word and symbol markings shall be located within 1,000 ft of where the full width preferential lane is established. When an existing general purpose lane is re-assigned as a preferential lane, the preferential word and symbol markings shall be located at the second guide sign location informing motorists of the lane designation change.**
- 02b **After a preferential lane has been established and is physically separated from the general purpose lanes, the preferential word and symbol markings shall not be repeated throughout the length of the preferential lane.**
- 03 **All longitudinal pavement markings, as well as word and symbol pavement markings, associated with a preferential lane shall end where the Preferential Lane Ends (R3-12a or R3-12c) sign (see Section 2G.07) designating the downstream end of the preferential only lane restriction is installed.**
- 04 **Static or changeable message regulatory signs (see Sections 2G.03 to 2G.07) shall be used with preferential lane word or symbol markings.**
- 05 **All preferential lane word and symbol markings shall be white and shall be positioned laterally in the center of the preferential lane.**
- 06 **Where a preferential lane use exists contiguous to a general-purpose lane or is separated from a general-purpose lane by a flush buffered space that can be traversed by motor vehicles, the preferential lane shall be marked with one or more of the following symbol or word markings for the preferential lane use specified:**
- A. **HOV lane—the preferential lane-use marking for high-occupancy vehicle lanes shall consist of white lines formed in a diamond shape symbol or the word message HOV. The diamond shall be at least 2.5 feet wide and 12 feet in length. The lines shall be at least 6 inches in width.**
 - B. **HOT lane or ETC Account-Only lane—except as provided in Paragraph 8, the preferential lane-use marking for a HOT lane or an ETC Account-Only lane shall consist of a word marking using the name of the ETC payment system required for use of the lane, such as E-Z PASS ONLY.**
 - C. **Bicycle lane—the preferential lane-use marking for a bicycle lane shall consist of a bicycle symbol or the word marking BIKE LANE (see Chapter 9C and Figures 9C-1 and 9C-3 through 9C-6).**
 - D. **Bus only lane—the preferential lane-use marking for a bus only lane shall consist of the word marking BUS ONLY.**
 - E. **Taxi only lane—the preferential lane-use marking for a taxi only lane shall consist of the word marking TAXI ONLY.**
 - F. **Light rail transit lane—the preferential lane-use marking for a light rail transit lane shall consist of the word marking LRT ONLY.**
 - G. **Other type of preferential lane—the preferential lane-use markings shall consist of a word marking appropriate to the restriction.**
- 07 **If two or more preferential lane uses are permitted in a single lane, the symbol or word marking for each preferential lane use shall be installed.**

Option:

- 08 Preferential lane-use symbol or word markings may be omitted at toll plazas where physical conditions preclude the use of the markings (see Section 3E.01).

Guidance:

09 *The spacing of the markings should be based on engineering judgment that considers the prevailing speed, block lengths, distance from intersections, and other factors that affect clear communication to the road user.*

Support:

10 Markings spaced as close as 80 feet apart might be appropriate on city streets, while markings spaced as far as 1,000 feet apart might be appropriate for freeways.

Guidance:

11 *Preferential lane markings should be placed at strategic locations such as major decision points, and along access openings to and from adjacent general-purpose lanes. At decision points, the preferential lane marking should be placed on all applicable lanes and should be visible to approaching traffic for all available departures.*

Option:

12 A numeral indicating the vehicle occupancy requirements established for a high-occupancy vehicle lane may be included in sequence after the diamond symbol or HOV word message.

Guidance:

13 *Engineering judgment should determine the need for supplemental devices such as tubular markers, traffic cones, or other channelizing devices (see Chapter 3H).*

Section 3D.02 Preferential Lane Longitudinal Markings for Motor Vehicles*Support:*

01 Preferential lanes can take many forms depending on the level of usage and the design of the facility. They might be barrier-separated or buffer-separated from the adjacent general-purpose lanes, or they might be contiguous with the adjacent general-purpose lanes. Barrier-separated preferential lanes might be operated in a constant direction or be operated as reversible lanes. Some reversible preferential lanes on a divided highway might be operated counter-flow to the direction of traffic on the immediately adjacent general-purpose lanes. See Section 1A.13 for definitions of terms.

02 Preferential lanes might be operated full-time (24 hours per day on all days), for extended periods of the day, part-time (restricted usage during specific hours on specified days), or on a variable basis (such as a strategy for a managed lane).

Standard:

03 **Longitudinal pavement markings for preferential lanes shall be as follows (these same requirements are presented in tabular form in Table 3D-1):**

- A. **Barrier-separated, non-reversible preferential lane—the longitudinal pavement markings for preferential lanes that are physically separated from the other travel lanes by a barrier or median shall consist of a normal solid single yellow line at the left-hand edge of the travel lane(s), and a normal solid single white line at the right-hand edge of the travel lane(s) (see Drawing A in Figure 3D-1).**
- B. **Barrier-separated, reversible preferential lane—the longitudinal pavement markings for reversible preferential lanes that are physically separated from the other travel lanes by a barrier or median shall consist of a normal solid single white line at both edges of the travel lane(s) (see Drawing B in Figure 3D-1).**
- C. **Buffer-separated (left-hand side) preferential lane—the longitudinal pavement markings for a full-time or part-time preferential lane on the left-hand side of and separated from the other travel lanes by a neutral buffer space shall consist of a normal solid single yellow line at the left-hand edge of the preferential travel lane(s) and one of the following at the right-hand edge of the preferential travel lane(s):**
 1. **A wide solid double white line along both edges of the buffer space where crossing the buffer space is prohibited (see Drawing A in Figure 3D-2).**
 2. **A wide solid single white line along both edges of the buffer space where crossing the buffer space is discouraged (see Drawing B in Figure 3D-2).**
 3. **A wide broken single white line along both edges of the buffer space, or a wide broken single white lane line within the allocated buffer space (resulting in wider lanes), where crossing the buffer space is permitted (see Drawing C in Figure 3D-2).**
- D. **Buffer-separated (right-hand side) preferential lane—the longitudinal pavement markings for a full-time or part-time preferential lane on the right-hand side of and separated from the other travel lanes by a neutral buffer space shall consist of a normal solid single white line at the right-hand edge of the preferential travel lane(s) if warranted (see Section 3B.07) and one of the following at the left-hand edge of the preferential travel lane(s) (see Drawing D in Figure 3D-2):**

Table 3D-1. Standard Edge Line and Lane Line Markings for Preferential Lanes

Type of Preferential Lane	Left-Hand Edge Line	Right-Hand Edge Line
Barrier-Separated, Non-Reversible	A normal solid single yellow line	A normal solid single white line (see Drawing A of Figure 3D-1)
Barrier-Separated, Reversible	A normal solid single white line	A normal solid single white line (see Drawing B of Figure 3D-1)
Buffer-Separated, Left-Hand Side	A normal solid single yellow line	A wide solid double white line along both edges of the buffer space where crossing is prohibited (see Drawing A of Figure 3D-2) A wide solid single white line along both edges of the buffer space where crossing is discouraged (see Drawing B of Figure 3D-2) A wide broken single white line along both edges of the buffer space, or a wide broken single white line within the buffer space (resulting in wider lanes), where crossing is permitted (see Drawing C of Figure 3D-2)
Buffer-Separated, Right-Hand Side	A wide solid double white line along both edges of the buffer space where crossing is prohibited (see Drawing D of Figure 3D-2) A wide solid single white line along both edges of the buffer space where crossing is discouraged (see Drawing D of Figure 3D-2) A wide broken single white line along both edges of the buffer space, or a wide broken single white line within the buffer space (resulting in wider lanes), where crossing is permitted (see Drawing D of Figure 3D-2) A wide dotted single white line within the buffer space (resulting in wider lanes) where crossing is permitted for any vehicle to perform a right-turn maneuver (see Drawing D of Figure 3D-2)	A normal solid single white line (if warranted)
Contiguous, Left-Hand Side	A normal solid single yellow line	A wide solid double white line where crossing is prohibited (see Drawing A of Figure 3D-3) A wide solid single white line where crossing is discouraged (see Drawing B of Figure 3D-3) A wide broken single white line where crossing is permitted (see Drawing C of Figure 3D-3)
Contiguous, Right-Hand Side	A wide solid double white line where crossing is prohibited (see Drawing D of Figure 3D-3) A wide solid single white line where crossing is discouraged (see Drawing D of Figure 3D-3) A wide broken single white line where crossing is permitted (see Drawing D of Figure 3D-3) A wide dotted single white line where crossing is permitted for any vehicle to perform a right-turn maneuver (see Drawing D of Figure 3D-3)	A normal solid single white line

Notes: 1. If there are two or more preferential lanes, the lane lines between the preferential lanes shall be normal broken white lines.
2. The standard lane markings listed in this table are provided in a tabular format for reference.
3. This information is also described in Paragraph 3 of Section 3D.02.

1. **A wide solid double white line along both edges of the buffer space where crossing the buffer space is prohibited.**
 2. **A wide solid single white line along both edges of the buffer space where crossing of the buffer space is discouraged.**
 3. **A wide broken single white line along both edges of the buffer space, or a wide broken single white line within the allocated buffer space (resulting in wider lanes), where crossing the buffer space is permitted.**
 4. **A wide dotted single white lane line within the allocated buffer space (resulting in wider lanes) where crossing the buffer space is permitted for any vehicle to perform a right- turn maneuver.**
- E. Contiguous (left-hand side) preferential lane—the longitudinal pavement markings for a full-time or part-time preferential lane on the left-hand side of and contiguous to the other travel lanes shall consist of a normal solid single yellow line at the left-hand edge of the preferential travel lane(s) and one of the following at the right-hand edge of the preferential travel lane(s):**
1. **A wide solid double white lane line where crossing is prohibited (see Drawing A in Figure 3D-3).**
 2. **A wide white line where crossing is discouraged (see Drawing B in Figure 3D 3).**
 3. **A wide broken single white lane line where crossing is permitted (see Drawing C in Figure 3D-3).**

F. Contiguous (right-hand side) preferential lane—the longitudinal pavement markings for a full-time or part-time preferential lane on the right-hand side of and contiguous to the other travel lanes shall consist of a normal solid single white line at the right-hand edge of the preferential travel lane(s) if warranted (see Section 3B.07) and one of the following at the left-hand edge of the preferential travel lane(s) (see Drawing D in Figure 3D-3):

1. A wide solid double white lane line where crossing is prohibited.
2. A wide solid single white lane line where crossing is discouraged.
3. A wide broken single white lane line where crossing is permitted.

4. A wide dotted single white lane line where crossing is permitted for any vehicle to perform a right-turn maneuver.

Guidance:

- 04 *Where preferential lanes and other travel lanes are separated by a buffer space wider than 4 feet and crossing the buffer space is prohibited, chevron markings (see Section 3B.24) should be placed in the buffer area (see Drawing A in Figure 3D-2). The chevron spacing should be 100 feet or greater.*

Option:

- 05 If a full-time or part-time contiguous preferential lane is separated from the other travel lanes by a wide broken single white line (see Drawing C in Figure 3D-3), the spacing or skip pattern of the line may be reduced and the width of the line may be increased.

Standard:

- 06 **If there are two or more preferential lanes for traffic moving in the same direction, the lane lines between the preferential lanes shall be normal broken white lines.**

- 07 **Preferential lanes for motor vehicles shall also be marked with the appropriate word or symbol pavement markings in accordance with Section 3D.01 and shall have appropriate regulatory signs in accordance with Sections 2G.03 through 2G.07.**

Guidance:

- 08 *At direct exits from a preferential lane, dotted white line markings should be used to separate the tapered or parallel deceleration lane for the direct exit (including the taper) from the adjacent continuing preferential through lane, to reduce the chance of unintended exit maneuvers.*

Standard:

- 09 **On a divided highway, a part-time counter-flow preferential lane that is contiguous to the travel lanes in the opposing direction shall be separated from the opposing direction lanes by the standard reversible lane longitudinal marking, a normal width broken double yellow line (see Section 3B.03 and Drawing A of Figure 3D-4). If a buffer space is provided between the part-time counter-flow preferential lane and the opposing direction lanes, a normal width broken double yellow line shall be placed along both edges of the buffer space (see Drawing B of Figure 3D-4). Signs (see Section 2B.26), lane-use control signals (see Chapter 4M), or both shall be used to supplement the reversible lane markings.**

- 10 **On a divided highway, a full-time counter-flow preferential lane that is contiguous to the travel lanes in the opposing direction shall be separated from the opposing direction lanes by a solid double yellow center line marking (see Drawing C of Figure 3D-4). If a buffer space is provided between the full-time counter-flow preferential lane and the opposing direction lanes, a normal width solid double yellow line shall be placed along both edges of the buffer space (see Drawing D of Figure 3D-4).**

Option:

- 11 Cones, tubular markers, or other channelizing devices (see Chapter 3H) may also be used to separate the opposing lanes when a counter-flow preferential lane operation is in effect.

Figure 3D-1. Markings for Barrier-Separated Preferential Lanes

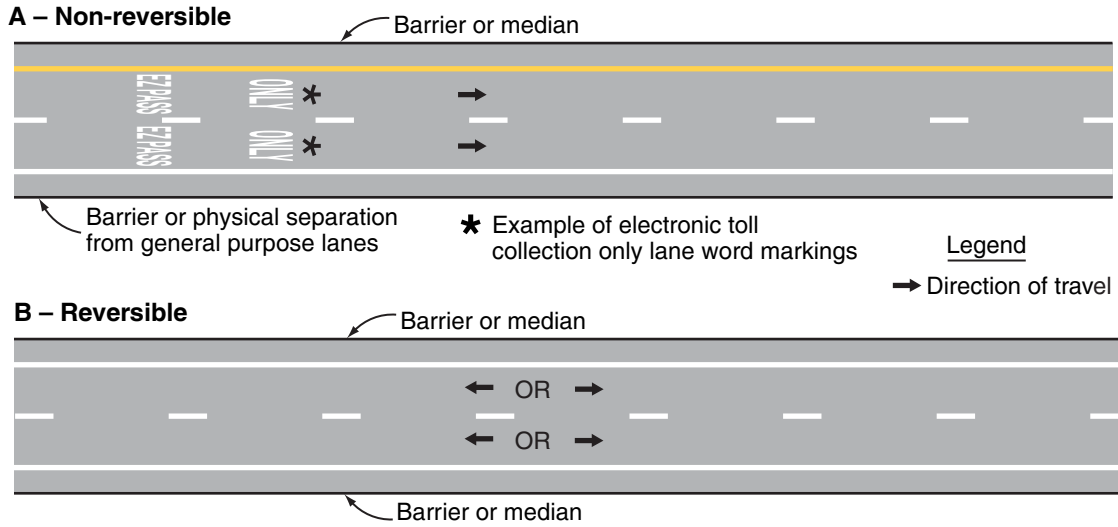

Figure 3D-2. Markings for Buffer-Separated Preferential Lanes (Sheet 1 of 2)

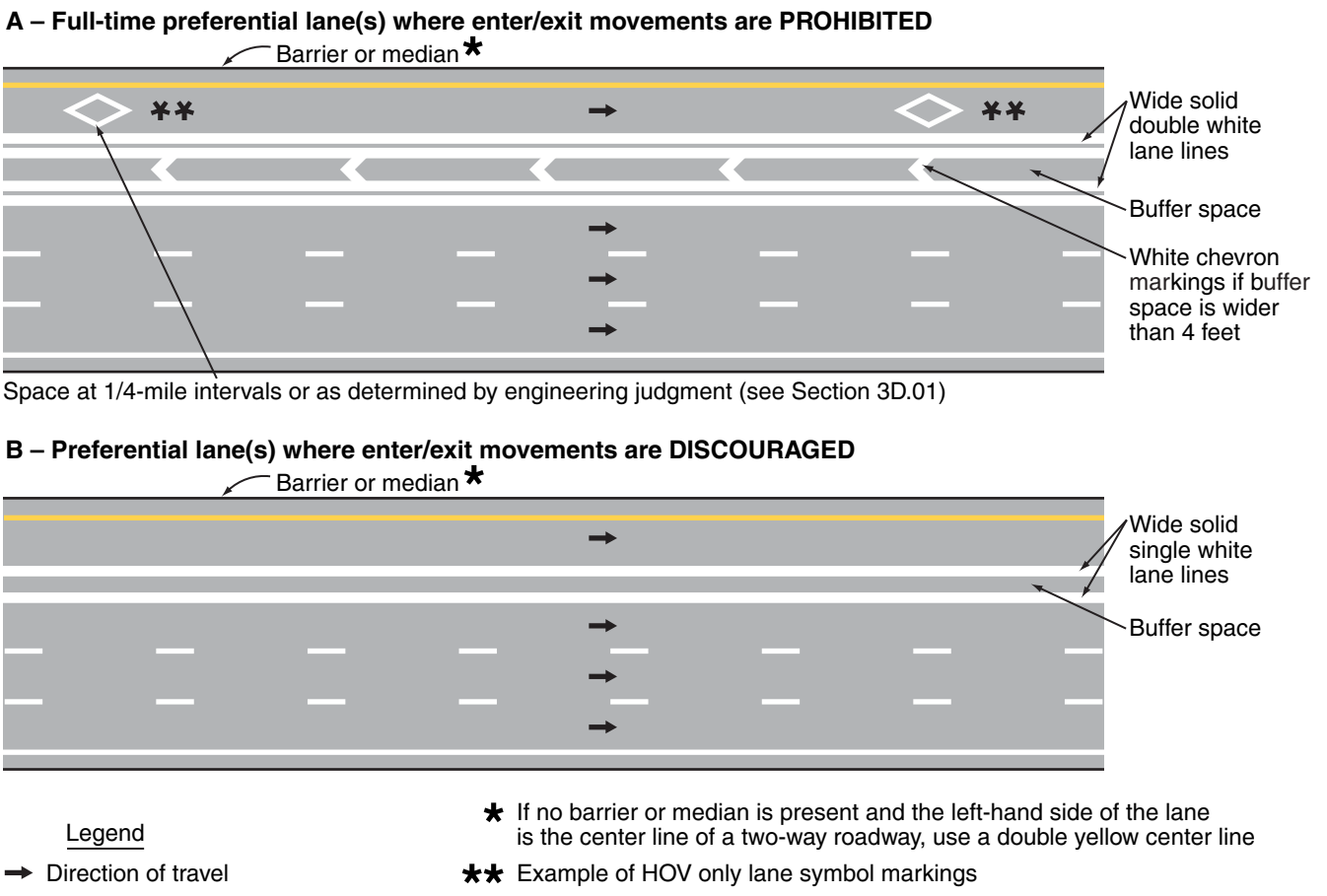
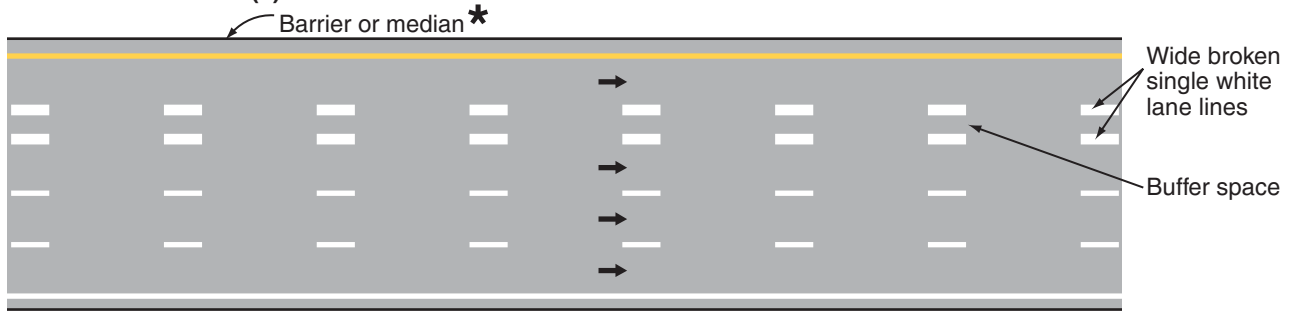
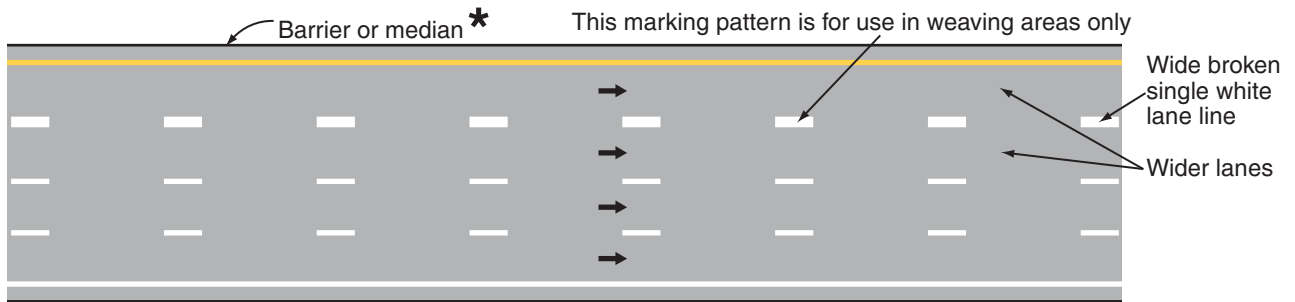

Figure 3D-2. Markings for Buffer-Separated Preferential Lanes (Sheet 2 of 2)

C – Preferential lane(s) where enter/exit movements are PERMITTED



OR



D – Right-hand side preferential lane(s)

Shall not be used in Maryland.



Legend

→ Direction of travel

* If no barrier or median is present and the left-hand side of the lane is the center line of a two-way roadway, use a double yellow center line

Figure 3D-3. Markings for Contiguous Preferential Lanes

A – Full-time preferential lane(s) where enter/exit movements are PROHIBITED

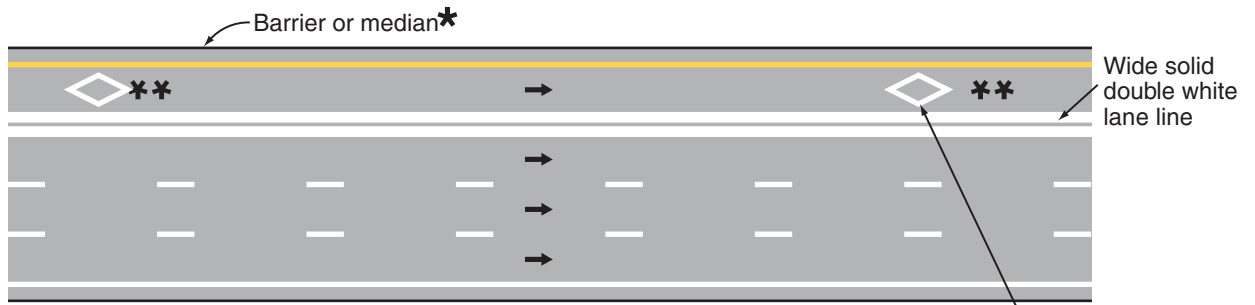

B – Preferential lane(s) where enter/exit movements are DISCOURAGED Space at 1/4-mile intervals

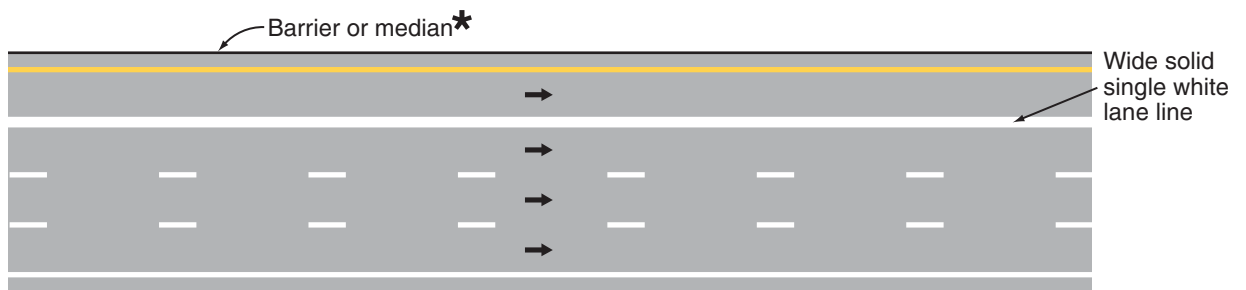

C – Preferential lane(s) where enter/exit movements are PERMITTED

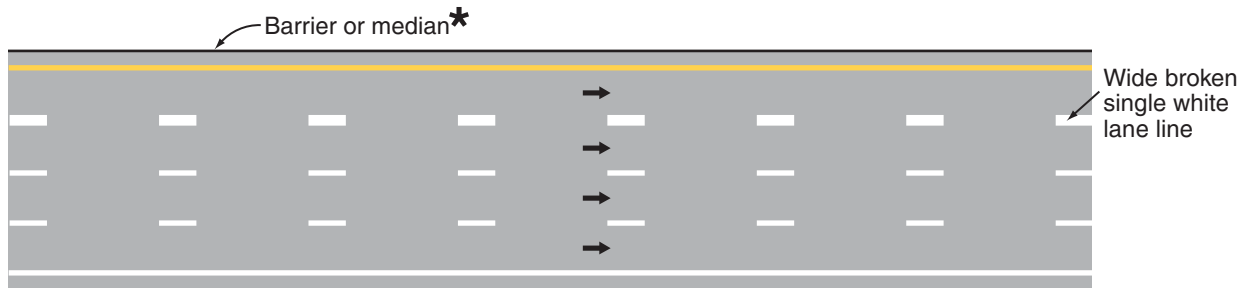

D – Right-hand side preferential lane(s)

Shall not be used in Maryland.



Legend
 → Direction of travel

- * If no barrier or median is present and the left-hand side of the lane is the center line of a two-way roadway, use a double yellow center line
- ** Example of HOV only lane symbol markings

Figure 3D-4. Markings for Counter-Flow Preferential Lanes on Divided Highways

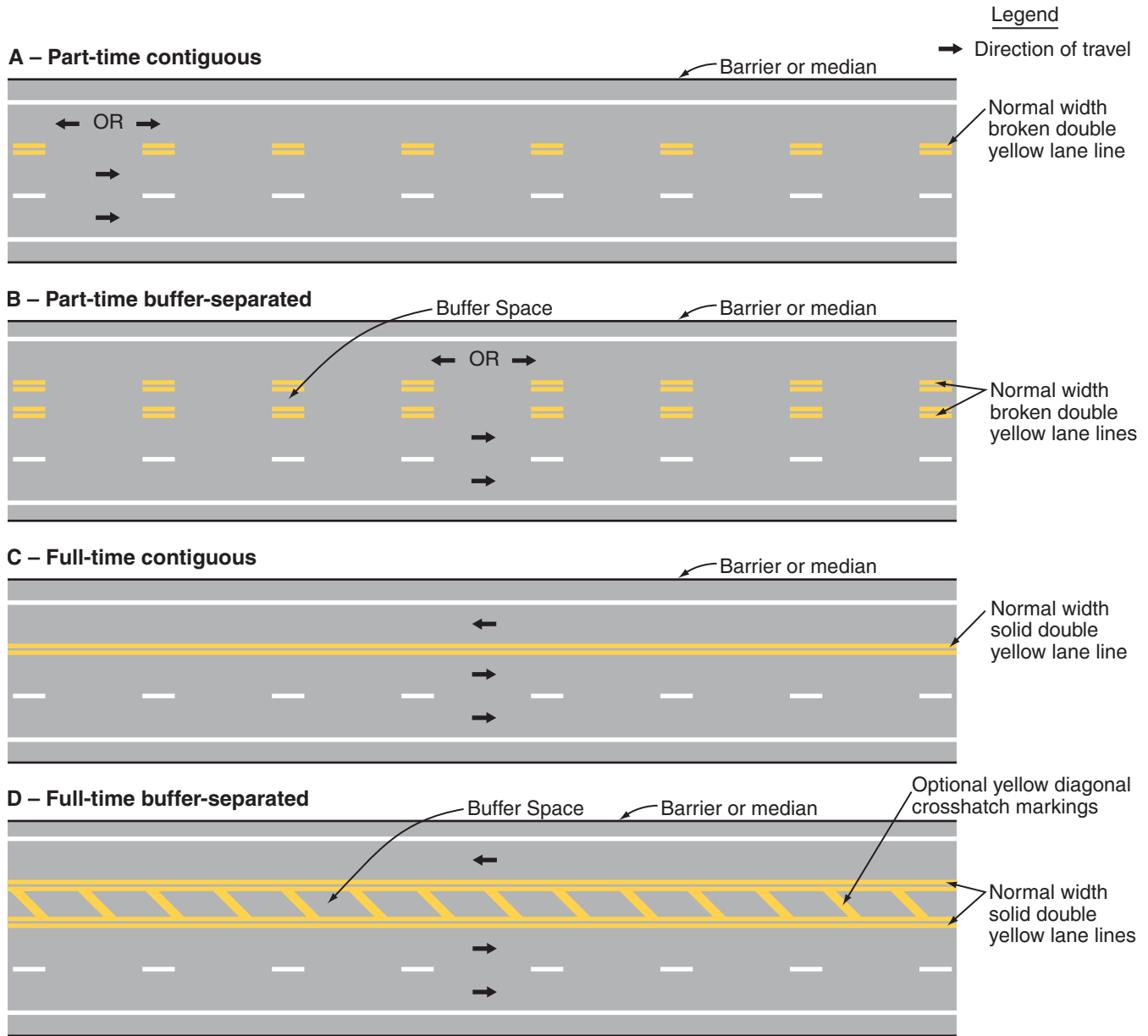

CHAPTER 3E. MARKINGS FOR TOLL PLAZAS

Section 3E.01 Markings for Toll Plazas

Support:

- 01 At toll plazas, pavement markings help road users identify the proper lane(s) to use for the type of toll payment they plan to use, to channelize movements into the various lanes, and to delineate obstructions in the roadway.

Standard:

- 02 **When a lane on the approach to a toll plaza is restricted to use only by vehicles with registered ETC accounts, the ETC Account-Only lane word markings described in Section 3D.01 and the preferential lane longitudinal markings described in Section 3D.02 shall be used (see Figure 3D-1). When one or more ORT lanes that are restricted to use only by vehicles with registered ETC accounts bypass a mainline toll plaza on a separate alignment, these word markings and longitudinal markings shall be used on the approach to the point where the ORT lanes diverge from the lanes destined for the mainline toll plaza.**

Option:

- 03 Preferential lane-use symbol or word markings may be omitted at toll plazas where physical conditions preclude the use of the markings.

Guidance:

- 04 *If an ORT lane that is immediately adjacent to a mainline toll plaza is not separated from adjacent cash payment toll plaza lanes by a curb or barrier, then channelizing devices (see Section 3H.01), and/or longitudinal pavement markings that discourage or prohibit lane changing should be used to separate the ORT lane from the adjacent cash payment lane. This separation should begin on the approach to the mainline toll plaza at approximately the point where the vehicle speeds in the adjacent cash lanes drop below 30 mph during off-peak periods and should extend downstream beyond the toll plaza approximately to the point where the vehicles departing the toll plaza in the adjacent cash lanes have accelerated to 30 mph.*

Option:

- 05 **Purple solid longitudinal markings are not used in Maryland.**

Standard:

- 06 **Purple solid longitudinal markings shall not be used in Maryland.**

- 07 **Toll booths and the islands on which they are located are considered to be obstructions in the roadway and they shall be provided with markings that comply with the provisions of Section 3B.10 and Chapter 3G.**

Option:

- 08 Longitudinal pavement markings may be omitted alongside toll booth islands between the approach markings and any departure markings.

CHAPTER 3F. DELINEATORS

Section 3F.01 Delineators

Support:

01 Delineators are particularly beneficial at locations where the alignment might be confusing or unexpected, such as at lane-reduction transitions and curves. Delineators are effective guidance devices at night and during adverse weather. An important advantage of delineators in certain locations is that they remain visible when the roadway is wet or snow covered.

02 Delineators are considered guidance devices rather than warning devices.

The “Roadway Delineation Standard” contains further information regarding roadway delineation. This document can be obtained from the State Highway Administration’s Office of Traffic and Safety, Traffic Engineering Design Division (TEDD) at the address shown on Page i.

Option:

03 Delineators may be used on long continuous sections of highway or through short stretches where there are changes in horizontal alignment.

Section 3F.02 Delineator Design

Standard:

01 **Delineators shall consist of retroreflective devices that are capable of clearly retroreflecting light under normal atmospheric conditions from a distance of 1,000 feet when illuminated by the high beams of standard automobile lights.**

02 **Retroreflective elements for delineators shall have a minimum dimension of 3 inches.**

Support:

03 Within a series of delineators along a roadway, delineators for a given direction of travel at a specific location are referred to as single delineators if they have one retroreflective element for that direction, double delineators if they have two identical retroreflective elements for that direction mounted together, or vertically elongated delineators if they have a single retroreflective element with an elongated vertical dimension to approximate the vertical dimension of two separate single delineators.

Option:

04 A vertically elongated delineator of appropriate size may be used in place of a double delineator.

Section 3F.03 Delineator Application

Standard:

01 **The color of delineators shall comply with the color of edge lines stipulated in Section 3B.06.**

02 **A series of single delineators shall be provided on the right-hand side of freeways and expressways and on at least one side of interchange ramps, except when either Condition A or Condition B is met, as follows:**

A. On tangent sections of freeways and expressways when both of the following conditions are met:

1. **Raised pavement markers are used continuously on lane lines throughout all curves and on all tangents to supplement pavement markings, and**
2. **Roadside delineators are used to lead into all curves.**

B. On sections of roadways where continuous lighting is in operation between interchanges.

Option:

03 Delineators may be provided on other classes of roads. A series of single delineators may be provided on the left-hand side of roadways.

Standard:

04 **Delineators on the left-hand side of a two-way roadway shall be white (see Figure 3F-1).**

Guidance:

05 *A series of single delineators should be provided on the outside of curves on interchange ramps.*

06 *Where median crossovers are provided for official or emergency use on divided highways and where these crossovers are to be marked, a double yellow delineator should be placed on the left-hand side of the through roadway on the far side of the crossover for each roadway.*

07 *Double or vertically elongated delineators should be installed at 100-foot intervals along acceleration and deceleration lanes.*

Figure 3F-1. Examples of Delineator Placement

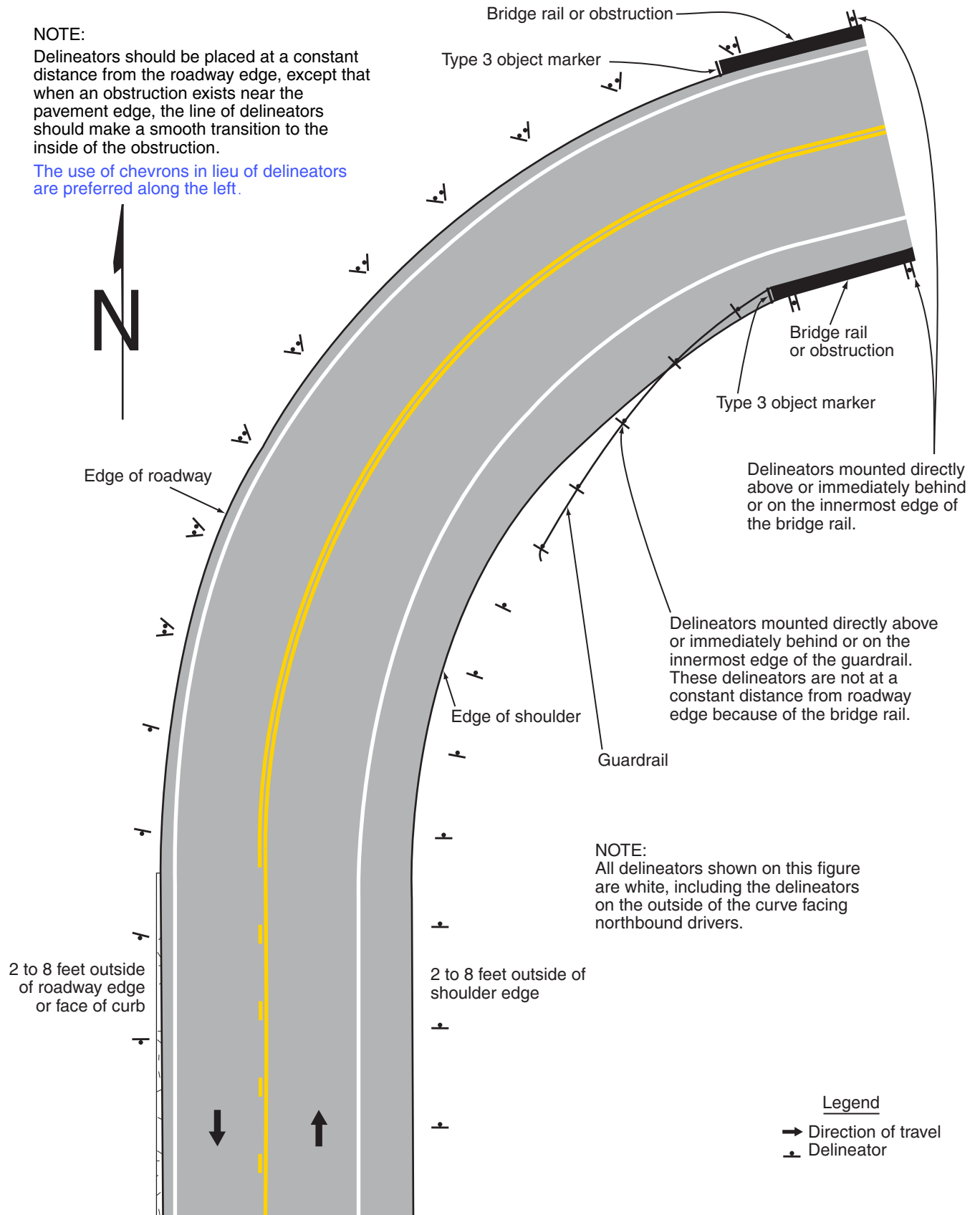

08 *A series of delineators should be used wherever guardrail or other longitudinal barriers are present along a roadway or ramp.*

Option:

09 Red delineators may be used on the reverse side of any delineator where it would be viewed by a road user traveling in the wrong direction on that particular ramp or roadway.

10 Delineators of the appropriate color may be used to indicate a lane-reduction transition where either an outside or inside lane merges into an adjacent lane.

Guidance:

11 *When used for lane-reduction transitions, the delineators should be installed adjacent to the lane or lanes reduced for the full length of the transition and should be so placed and spaced to show the reduction (see Figure 3B-14).*

Support:

12 Delineators are not necessary for traffic moving in the direction of a wider pavement or on the side of the roadway where the alignment is not affected by the lane-reduction transition.

Guidance:

13 *On a highway with continuous delineation on either or both sides, delineators should be carried through transitions.*

Option:

14 On a highway with continuous delineation on either or both sides, the spacing between a series of delineators may be closer.

Standard:

15 **When used on a truck escape ramp, delineators shall be red.**

Guidance:

16 *Red delineators should be placed on both sides of truck escape ramps. The delineators should be spaced at 50-foot intervals for a distance sufficient to identify the ramp entrance. Delineator spacing beyond the ramp entrance should be adequate for guidance according to the length and design of the escape ramp.*

Section 3F.04 Delineator Placement and Spacing

Guidance:

01 *Delineators should be mounted on suitable supports at a mounting height, measured vertically from the bottom of the lowest retroreflective device to the elevation of the near edge of the roadway, of approximately 4 feet.*

Option:

02 When mounted on the face of or on top of guardrails or other longitudinal barriers, delineators may be mounted at a lower elevation than the normal delineator height recommended in Paragraph 1.

Guidance:

03 *Delineators should be placed 2 to 8 feet outside the outer edge of the shoulder, or if appropriate, in line with the roadside barrier that is 8 feet or less outside the outer edge of the shoulder.*

04 *Delineators should be placed at a constant distance from the edge of the roadway, except that where an obstruction intrudes into the space between the pavement edge and the extension of the line of the delineators, the delineators should be transitioned to be in line with or inside the innermost edge of the obstruction. If the obstruction is a guardrail or other longitudinal barrier, the delineators should be transitioned to be just behind, directly above (in line with), or on the innermost edge of the guardrail or longitudinal barrier.*

05 *Delineators should be spaced 200 to 530 feet apart on mainline tangent sections. Delineators should be spaced 100 feet apart on ramp tangent sections.*

Support:

06 Examples of delineator installations are shown in Figure 3F-1. Option:

07 When uniform spacing is interrupted by such features as driveways and intersections, delineators which would ordinarily be located within the features may be relocated in either direction for a distance not exceeding one quarter of the uniform spacing. Delineators still falling within such features may be eliminated.

08 Delineators may be transitioned in advance of a lane transition or obstruction as a guide for oncoming traffic.

Guidance:

- 09 *The spacing of delineators should be adjusted on approaches to and throughout horizontal curves so that several delineators are always simultaneously visible to the road user. The approximate spacing shown in Table 3F-1 should be used.*

Option:

- 10 When needed for special conditions, delineators of the appropriate color may be mounted in a closely-spaced manner on the face of or on top of guardrails or other longitudinal barriers to form a continuous or nearly continuous “ribbon” of delineation.

Table 3F-1. Approximate Spacing for Delineators on Horizontal Curves *

Radius (R) of Curve	Approximate Spacing (S) on Curve
50 feet	20 feet
115 feet	25 feet
180 feet	35 feet
250 feet	40 feet
300 feet	50 feet
400 feet	55 feet
500 feet	65 feet
600 feet	70 feet
700 feet	75 feet
800 feet	80 feet
900 feet	85 feet
1,000 feet	90 feet

- Notes:
1. Spacing for specific radii may be interpolated from table.
 2. The minimum spacing should be 20 feet.
 3. The spacing on curves should not exceed 300 feet.
 4. In advance of or beyond a curve, and proceeding away from the end of the curve, the spacing of the first delineator is 2S, the second 3S, and the third 6S, but not to exceed 300 feet.
 5. S refers to the delineator spacing for specific radii computed from the formula $S=3\sqrt{R-50}$.
 6. The distances for S shown in the table above were rounded to the nearest 5 feet.

- * The “Roadway Delineation Standard” contains further information regarding roadway delineation. This document can be obtained from the State Highway Administration’s Office of Traffic & Safety, Traffic Engineering Design Division (TEDD) at the address shown on Page i.

CHAPTER 3G. COLORED PAVEMENTS

Section 3G.01 General

Support:

01 Colored pavements consist of differently colored road paving materials, such as colored asphalt or concrete, or
paint or other marking materials applied to the surface of a road or island to simulate a colored pavement.

02 If non-retroreflective colored pavement, including bricks and other types of patterned surfaces, used as a
purely aesthetic treatment and is not intended to communicate a regulatory, warning, or guidance message to road
users, the colored pavement is not considered to be a traffic control device, even if it is located between the lines of
a crosswalk.

Standard:

03 **If colored pavement is used within the traveled way, on flush or raised islands, or on shoulders to
regulate, warn, or guide traffic or if retroreflective colored pavement is used, the colored pavement is
considered to be a traffic control device and shall be limited to the following colors and applications:**

**A. Yellow pavement color shall be used only for flush or raised median islands separating traffic flows
in opposite directions or for left-hand shoulders of roadways of divided highways or one-way streets
or ramps.**

**B. White pavement color shall be used for flush or raised channelizing islands where traffic passes on
both sides in the same general direction or for right-hand shoulders.**

04 **Colored pavements shall not be used as a traffic control device, unless the device is applicable at all
times.**

Guidance:

05 *Colored pavements used as traffic control devices should be used only where they contrast significantly with
adjoining paved areas.*

06 *Colored pavement located between crosswalk lines should not use colors or patterns that degrade the contrast
of white crosswalk lines, or that might be mistaken by road users as a traffic control application.*

CHAPTER 3H. CHANNELIZING DEVICES USED FOR EMPHASIS OF PAVEMENT MARKING PATTERNS

Section 3H.01 Channelizing Devices

Option:

- 01 Channelizing devices, as described in Sections 6F.63 through 6F.73, and 6F.75, and as shown in Figure 6F-7, such as cones, tubular markers, vertical panels, drums, lane separators, and raised islands, may be used for general traffic control purposes such as adding emphasis to reversible lane delineation, channelizing lines, or islands. Channelizing devices may also be used along a center line to preclude turns or along lane lines to preclude lane changing, as determined by engineering judgment.

Standard:

- 02 **Except for color, the design of channelizing devices, including but not limited to retroreflectivity, minimum dimensions, and mounting height, shall comply with the provisions of Chapter 6F.**
- 03 **The color of channelizing devices used outside of temporary traffic control zones shall be either orange or the same color as the pavement marking that they supplement, or for which they are substituted.**
- 04 **For nighttime use, channelizing devices shall be retroreflective (as described in Part 6) or internally illuminated. On channelizing devices used outside of temporary traffic control zones, retroreflective sheeting or bands shall be white if the devices separate traffic flows in the same direction and shall be yellow if the devices separate traffic flows in the opposite direction or are placed along the left-hand edge line of a one-way roadway or ramp.**

Guidance:

- 05 *Channelizing devices should be kept clean and bright to maximize target value.*

CHAPTER 3I. ISLANDS

Section 3I.01 General

Support:

- 01 This Chapter addresses the characteristics of islands (see definition in Section 1A.13) as traffic-control devices. Criteria for the design of islands are set forth in “A Policy on Geometric Design of Highways and Streets” (see Section 1A.11).

Option:

- 02 An island may be designated by curbs, pavement edges, pavement markings, channelizing devices, or other devices.

Section 3I.02 Approach-End Treatment

Guidance:

- 01 *The ends of islands first approached by traffic should be preceded by diverging longitudinal pavement markings on the roadway surface, to guide vehicles into desired paths of travel along the island edge.*

Support:

- 02 The neutral area between approach-end markings that can be readily crossed even at considerable speed sometimes contains slightly raised (usually less than 1 inch high) sections of coarse aggregate or other suitable materials to create rumble sections that provide increased visibility of the marked areas and that produce an audible warning to road users traveling across them. For additional discouragement to driving in the neutral area, bars or buttons projecting 1 to 3 inches above the pavement surface are sometimes placed in the neutral area. These bars or buttons are designed so that any wheel encroachment within the area will be obvious to the vehicle operator, but will result in only minimal effects on control of the vehicle. Such bars or buttons are sometimes preceded by rumble sections or their height is gradually increased as approached by traffic.

Guidance:

- 03 *When raised bars or buttons are used in these neutral areas, they should be marked with white or yellow retroreflective materials, as determined by the direction or directions of travel they separate.*

Standard:

- 04 **Channelizing devices, when used in advance of islands having raised curbs, shall not be placed in such a manner as to constitute an unexpected obstacle.**

Option:

- 05 Pavement markings may be used with raised bars to better designate the island area.

Section 3I.03 Island Marking Application

Standard:

- 01 **Markings, as related to islands, shall consist only of pavement and curb markings, channelizing devices, and delineators.**

Option:

- 02 Pavement markings as described in Section 3B.10 for the approach to an obstruction may be omitted on the approach to a particular island based on engineering judgment.

Section 3I.04 Island Marking Colors

Guidance:

- 01 *Islands outlined by curbs or pavement markings should be marked with retroreflective white or yellow material as determined by the direction or directions of travel they separate (see Section 3A.05).*

- 02 *The retroreflective area should be of sufficient length to denote the general alignment of the edge of the island along which vehicles travel, including the approach end, when viewed from the approach to the island.*

Option:

- 03 On long islands, curb retroreflection may be discontinued such that it does not extend for the entire length of the curb, especially if the island is illuminated or marked with delineators or edge lines.

Section 3I.05 Island Delineation**Standard:**

- 01 **Delineators installed on islands shall be the same colors as the related edge lines except that, when facing wrong-way traffic, they shall be red (see Section 3F.03).**
- 02 **Each roadway through an intersection shall be considered separately in positioning delineators to assure maximum effectiveness.**

Option:

- 03 Retroreflective or internally illuminated raised pavement markers of the appropriate color may be placed on the pavement in front of the curb and/or on the top of curbed approach ends of raised medians and curbs of islands, as a supplement to or as a substitute for retroreflective curb markings.

Section 3I.06 Pedestrian Islands and Medians**Support:**

- 01 Raised islands or medians of sufficient width that are placed in the center area of a street or highway can serve as a place of refuge for pedestrians who are attempting to cross at a midblock or intersection location. Center islands or medians allow pedestrians to find an adequate gap in one direction of traffic at a time, as the pedestrians are able to stop, if necessary, in the center island or median area and wait for an adequate gap in the other direction of traffic before crossing the second half of the street or highway. The minimum widths for accessible refuge islands and for design and placement of detectable warning surfaces are provided in the “Americans with Disabilities Act Accessibility Guidelines for Buildings and Facilities (ADAAG)” (see Section 1A.11).

CHAPTER 3J. RUMBLE STRIP MARKINGS

Section 3J.01 Longitudinal Rumble Strip Markings

Support:

01 Longitudinal rumble strips consist of a series of rough-textured or slightly raised or depressed road surfaces intended to alert inattentive drivers through vibration and sound that their vehicle has left the travel lane. Shoulder rumble strips are typically installed along the shoulder near the travel lane. On divided highways, rumble strips are sometimes installed on the median side (left-hand side) shoulder as well as on the outside (right-hand side) shoulder. On two-way roadways, rumble strips are sometimes installed along the center line.

02 This Manual contains no provisions regarding the design and placement of longitudinal rumble strips. The provisions in this Manual address the use of markings in combination with a longitudinal rumble strip.

Option:

03 An edge line or center line may be located over a longitudinal rumble strip to create a rumble stripe.

Standard:

04 **The color of an edge line or center line associated with a longitudinal rumble stripe shall be in accordance with Section 3A.05.**

05 **An edge line shall not be used in addition to a rumble stripe that is located along a shoulder.**

Support:

06 Figure 3J-1 illustrates markings used with or near longitudinal rumble strips.

Section 3J.02 Transverse Rumble Strip Markings

Support:

01 Transverse rumble strips consist of intermittent narrow, transverse areas of rough-textured or slightly raised or depressed road surface that extend across the travel lanes to alert drivers to unusual vehicular traffic conditions. Through noise and vibration, they attract the attention of road users to features such as unexpected changes in alignment and conditions requiring a reduction in speed or a stop.

02 This Manual contains no provisions regarding the design and placement of transverse rumble strips that approximate the color of the pavement. The provisions in this Manual address the use of markings in combination with a transverse rumble strip.

Standard:

03 **Except as otherwise provided in Section 6F.87 for TTC zones, if the color of a transverse rumble strip used within a travel lane is not the color of the pavement, the color of the transverse rumble strip shall be either black or white.**

Guidance:

04 *White transverse rumble strips used in a travel lane should not be placed in locations where they could be confused with other transverse markings such as stop lines or crosswalks.*

Figure 3J-1. Examples of Longitudinal Rumble Strip Markings

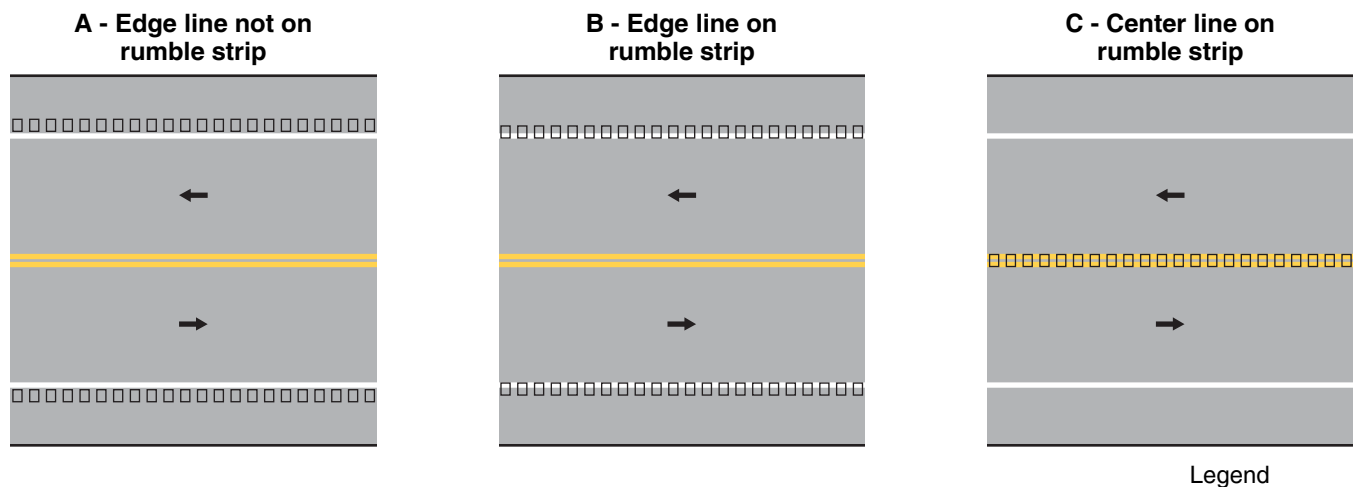

Note: Edge line may be located alongside the rumble strip (Option A) or on the rumble strip (Option B). Center line markings may also be located on a center line rumble strip (Option C).